

CATALOGO

CATALOGUE



rel. 1806

KIT TENDICATENA

TIMING CHAIN KIT



<b>CAPITOLI CHAPTERS</b>		
<b>Istruzioni</b>	<b>0</b>	<b><i>Instructions</i></b>
<b>Motori per modello</b>	<b>1</b>	<b><i>Engine per model</i></b>
<b>Kit tendicatena per motore</b>	<b>2</b>	<b><i>Timing chain kit per engine</i></b>
<b>Kit tendicatena</b>	<b>3</b>	<b><i>Timing chain kit</i></b>

Questo catalogo contiene dati ed informazioni provenienti dalla pluriennale esperienza di Finimpianti. Tuttavia non possiamo assumere alcuna responsabilità per eventuali dati errati od incompleti.

Tutti i dati e le informazioni contenute nel presente catalogo sono fornite a puro scopo informativo e senza responsabilità e non potranno dare adito ad alcuna forma di risarcimento.

Visto il continuo sviluppo dei nostri prodotti, Finimpianti si riserva il diritto di apportare modifiche senza preavviso.

Denominazioni, numeri e codici originali sono riportati a puro titolo di riferimento.

*All the information and data contained in this catalogue came from the long Finimpianti experience. Nevertheless we can not assume any responsibility for possible mistakes.*

*All the information and data contained in this catalogue are provide "as is" without any representation or warranty express or implied. Under no circumstances whatsoever shall Finimpianti be liable for any damages whatsoever arising out of the use of the information and data contained in this catalogue.*

*Finimpianti does not warrant the accuracy or completeness of the materials and content contained in this catalogue and reserves the right to correct any errors or omissions at any time without notice and without obligation to the users of this catalogue.*

# ISTRUZIONI

## *INSTRUCTIONS*

Questo catalogo contiene dati ed informazioni provenienti dalla pluriennale esperienza di Finimpianti. Tuttavia non possiamo assumere alcuna responsabilità per eventuali dati errati od incompleti.

Tutti i dati e le informazioni contenute nel presente catalogo sono fornite a puro scopo informativo e senza responsabilità e non potranno dare adito ad alcuna forma di risarcimento.

Visto il continuo sviluppo dei nostri prodotti, Finimpianti si riserva il diritto di apportare modifiche senza preavviso.

Denominazioni, numeri e codici originali sono riportati a puro titolo di riferimento.

*All the information and data contained in this catalogue came from the long Finimpianti experience. Nevertheless we can not assume any responsibility for possible mistakes.*

*All the information and data contained in this catalogue are provide "as is" without any representation or warranty express or implied. Under no circumstances whatsoever shall Finimpianti be liable for any damages whatsoever arising out of the use of the information and data contained in this catalogue.*

*Finimpianti does not warrant the accuracy or completeness of the materials and content contained in this catalogue and reserves the right to correct any errors or omissions at any time without notice and without obligation to the users of this catalogue.*

**COME LEGGERE IL CATALOGO**

**HOW TO READ THE CATALOGUE**

1

Dal modello del veicolo risalire al motore

From the vehicle type get the engine

MODELLO VEICOLO  
VEHICLE MODEL

MOTORE ENGINE

2

Dal motore risalire al codice del kit tendicatena

From the engine get the timing chain kit reference

MOTORE ENGINE

KIT TENDICATENA TIMING CHAIN KIT

3

Dal codice del kit tendicatena risalire alla sua composizione e ulteriori applicazioni

From the timing chain kit reference get the kit composition and more applications

**KIT TENDICATENA**

**SRI030061KSK** 4 pcs

composizione :	q.ty	composition:
CATENA DI DISTRIBUZIONE	1	TIMING CHAIN
PATTINO	2	GUIDE
TENDICATENA	1	TENSIONER

adattabile a: suitable for :	motore: engine :	
BMW	M43B16164E2 M43B16164E3	M43B18194E2 M43B19194E1

**TIMING CHAIN KIT**

**SRI030064KSK** 5 pcs

composizione :	q.ty	composition:
CATENA DI DISTRIBUZIONE	1	TIMING CHAIN
TENDICATENA	1	TENSIONER
GUIDA CATENA	2	CHAIN GUIDE
INGRANAGGIO	1	GEAR

adattabile a: suitable for :	motore: engine :	
BMW	N40B16A	N45B16A

**SRI030062KSK** 5 pcs

composizione :	q.ty	composition:
CATENA DI DISTRIBUZIONE	1	TIMING CHAIN
TENDICATENA	1	TENSIONER
GUIDA CATENA	2	CHAIN GUIDE
INGRANAGGIO	1	GEAR

adattabile a: suitable for :	motore: engine :	
BMW	N42B18A N42B20A N46B18A N46B20A N46B20B	N46B20BD N46B20C N46B20CC N46B20CD N46B20E

**SRI030065KSK** 16 pcs

composizione :	q.ty	composition:
CATENA DI DISTRIBUZIONE	1	TIMING CHAIN
TENDICATENA	1	TENSIONER
PATTINO	3	GUIDE
INGRANAGGIO	3	GEAR
VITI BULLONI	7	SCREWS BOLTS
RONDELLI	1	WASHERS

adattabile a: suitable for :	motore: engine :	
ALFA ROMEO	939A5000	939A6000
FIAT	194A1000	
OPEL	Z22SE	Z22YH
VADONALL	Z22SE	Z22YH

CODICE KIT TENDICATENA  
TIMING CHAIN KIT REFERENCE

COMPONENTI  
COMPONENTS

APPLICAZIONI  
APPLICATIONS



Informazioni quali nomi, descrizioni e numeri di motore, veicoli, prodotti, costruttori, ecc. sono riportati a puro titolo di riferimento. In questo catalogo si trovano ricambi di qualità garantiti da Finimpianti adattabili ai motori ed ai veicoli indicati.

11

rel. 1806

Information such as names, descriptions and numbers of engines, vehicles, products, manufacturers, etc. are used for comparison purpose only. In this catalogue are listed guaranteed Finimpianti quality spare parts suitable for the engines and vehicles indicated.



## MOTORI PER MODELLO *ENGINE PER MODEL*

<b>ALFA ROMEO</b>	<b>1</b>
<b>AUDI</b>	<b>1</b>
<b>BMW</b>	<b>1</b>
<b>CHEVROLET</b>	<b>6</b>
<b>CITROËN</b>	<b>7</b>
<b>DAIHATSU</b>	<b>10</b>
<b>FIAT</b>	<b>10</b>
<b>FORD</b>	<b>13</b>
<b>HYUNDAI</b>	<b>21</b>
<b>IVECO</b>	<b>22</b>
<b>KIA</b>	<b>26</b>
<b>LADA</b>	<b>27</b>
<b>LANCIA</b>	<b>27</b>
<b>MAZDA</b>	<b>27</b>
<b>MERCEDES</b>	<b>27</b>
<b>MINI</b>	<b>35</b>
<b>MITSUBISHI</b>	<b>36</b>
<b>NISSAN</b>	<b>36</b>
<b>OPEL</b>	<b>37</b>
<b>PEUGEOT</b>	<b>40</b>
<b>RENAULT</b>	<b>44</b>
<b>SEAT</b>	<b>45</b>
<b>SKODA</b>	<b>47</b>
<b>SMART</b>	<b>48</b>
<b>SUZUKI</b>	<b>48</b>
<b>TOYOTA</b>	<b>49</b>
<b>VAUXHALL</b>	<b>49</b>
<b>VOLVO</b>	<b>52</b>
<b>VOLKSWAGEN</b>	<b>52</b>

Questo catalogo contiene dati ed informazioni provenienti dalla pluriennale esperienza di Finimpianti. Tuttavia non possiamo assumere alcuna responsabilità per eventuali dati errati od incompleti.

Tutti i dati e le informazioni contenute nel presente catalogo sono fornite a puro scopo informativo e senza responsabilità e non potranno dare adito ad alcuna forma di risarcimento.

Visto il continuo sviluppo dei nostri prodotti, Finimpianti si riserva il diritto di apportare modifiche senza preavviso.

Denominazioni, numeri e codici originali sono riportati a puro titolo di riferimento.

*All the information and data contained in this catalogue came from the long Finimpianti experience. Nevertheless we can not assume any responsibility for possible mistakes.*



*All the information and data contained in this catalogue are provide "as is" without any representation or warranty express or implied. Under no circumstances whatsoever shall Finimpianti be liable for any damages whatsoever arising out of the use of the information and data contained in this catalogue.*

*Finimpianti does not warrant the accuracy or completeness of the materials and content contained in this catalogue and reserves the right to correct any errors or omissions at any time without notice and without obligation to the users of this catalogue.*



**MOTORI PER MODELLO**

**ENGINE PER MODEL**

**ALFA ROMEO**



				
model	version	c.c.	engine	
1	159 (939A)	1.9 JTS	1859	939A6000
		2.2 JTS	2198	939A5000
		2.2 Q4	2198	939A5000
2	159 Sportwagon (939B)	1.9 JTS	1859	939A6000
		2.2 JTS	2198	939A5000
3	Brera (939D)	2.2 JTS	2198	939A5000
4	Mito (955)	0.9	875	199B6000
				312A2000
				199A3000
		1.3 JTDM	1248	199B1000
				199B4000
				199B8000
				330A1000
5	Spider (939E)	2.2 JTS	2198	939A5000

**AUDI**

						
model	version	c.c.	engine			
1	A1 (8X1-8XK)	1.2 TFSI	1197	CBZA		
				CAVG		
		1.4 TFSI	1390	CAXA		
				CNVA		
				CTJA		
2	A1 Sportback (8XA)	1.2 TFSI	1197	CBZA		
				CAVG		
		1.4 TFSI	1390	CAXA		
				CNVA		
				CTJA		
3	A2 (8Z0)	1.2 TDI	1191	ANY		
				AMF		
		1.4 TDI	1422	ATL		
				BHC		
4	A3 (8P1)	1.2 TSI	1197	CBZB		
				CAXC		
		1.4 TFSI	1390	CMSA		
				BAG		
				BLF		
5	A3 Cabrio (8P7)	1.2 TSI	1197	CBZB		
				1.4 TFSI	1390	CAXC
				1.6 FSI	1598	BLP
6	A3 Sportback (8PA)	1.2 TSI	1197	CBZB		
				1.4 TFSI	1390	CAXC
				CMSA		



6	A3 Sportback (8PA)	1.6 FSI	1598	BAG
				BLF
				BLP

**BMW**

				
model	version	c.c.	engine	
1	1-Serie (E81)	116 d	1995	N47D20A
				N47D20C
		116 i	1596	N45B16A
				M47D20204D4
		118 d	1995	N47D20A
				N47D20C
		118 i	1995	N46B20B
				M47D20204D4
		120 d	1995	N47D20A
				N47D20C
		120 i	1995	N46B20B
				N46B20C
		123 d	1995	N47D20B
				N47D20D
		2	1-Serie (E87)	116 d
N47D20C				
116 i	1596			N45B16A
				M47D20204D4
118 d	1995			N47D20A
				N47D20C
118 i	1995			N46B20B
				M47D20204D4
120 d	1995			M47N204D4
				N47D20A
120 i	1995			N46B20B
				N46B20BD
120 i	1995			N46B20C
				N46B20CC
120 i	1995			N46B20CD
		N47D20B		
123 d	1995	N47D20C		
		N47D20D		
3	1-Serie (F20)	114 d	1496	B37D15A
			1598	N47D16A
		116 d	1598	N47D16A
			1995	N47D20C
		116 d EfficientDynamics	1496	B37D15A
			1995	N47D20C
118 d xDrive	1995	N47D20C		
	1995	N47D20C		

**MOTORI PER MODELLO**



**ENGINE PER MODEL**

BMW				
				
	model	version	c.c.	engine
3	1-Serie (F20)	120 d xDrive	1995	N47D20C
		125 d	1995	N47D20D
4	1-Serie (F21)	114 d	1496	B37D15A
			1598	N47D16A
		116 d	1598	N47D16A
			1995	N47D20C
			1496	B37D15A
		116 d EfficientDynamics	1496	B37D15A
		118 d	1995	N47D20C
		118 d xDrive	1995	N47D20C
		120 d	1995	N47D20C
		120 d xDrive	1995	N47D20C
125 d	1995	N47D20D		
5	1-Serie Cabrio (E88)	118 d	1995	N47D20A
			1995	N47D20C
		118 i	1995	N46B20B
			1995	N47D20A
		120 d	1995	N47D20C
			1995	N46B20B
		120 i	1995	N46B20C
1995	N46B20E			
6	1-Serie Coupé (E82)	118 d	1995	N47D20C
			1995	N47D20A
		120 d	1995	N47D20C
			1995	N46B20B
123 d	1995	N47D20B		
	1995	N47D20D		
7	2-Serie Active Tourer (F45)	214 d	1496	B37C15A
		216 d	1496	B37C15A
8	2-Serie Coupé (F22)	218 D	1995	N47D20C
		220 D	1995	N47D20C
		225 D	1995	N47D20D
9	2-Serie Gran Tourer (F46)	214 d	1496	B37C15A
		216 d	1496	B37C15A
10	3-Serie (E36)	316 i	1596	M43B16164E2
		318 i	1796	M43B18184E2
		318 tds	1665	M41D17174T1
		325 td	2497	M51D25256T1
		325 tds	2497	M51D25256T1
11	3-Serie (E46)	316 i	1596	M43B16164E3
			1995	N40B16A
			1995	N45B16A
		1796	1995	N42B18A
			1995	N46B18A
			1895	M43B19194E1

11	3-Serie (E46)	318 d	1995	M47D20204D4
		318 i	1895	M43B19194E1
			1995	N42B20A
			1995	N46B20A
		320 d	1995	M47D20204D4
		323 i	1895	M43B19194E1
		330 d	2993	M57D30306D2
		330 xd	2993	M57D30306D2
		316 d	1995	N47D20C
		316 i	1596	N45B16A
12	3-Serie (E90)	318 d	1995	M47D20204D4
			1995	N47D20A
			1995	N47D20C
		318 i	1995	N46B20B
			1995	N46B20E
		320 d	1995	M47D20204D4
			1995	M47N204D4
			1995	N47D20A
		320 d xDrive	1995	N47D20C
			1995	N47D20A
		320 i	1995	N46B20A
			1995	N46B20B
		320 xd	1995	N46B20C
			1995	N47D20A
325 d	2993	N47D20C		
	2993	M57D30306D3		
330 d	2993	N57D30A		
	2993	M57306D3		
	2993	M57D30306D3		
330 d xDrive	2993	M57N2306D3		
	2993	N57D30A		
330 xd	2993	N57D30A		
	2993	M57306D3		
335 d	2993	M57D30306D5		
	2993	M57D30306D3		
13	3-Serie (F30)	316 d	1995	N47D20C
		318 d	1995	N47D20C
		318 d xDrive	1995	N47D20C
		320 d	1995	N47D20C
		320 d xDrive	1995	N47D20C
		325 d	1995	N47D20D
		330 d	2993	N57D30A
		330 d xDrive	2993	N57D30A
14	3-Serie Cabrio (E36)	318 i	1796	M43B18184E2
		1796	N46B18A	

**MOTORI PER MODELLO**

**ENGINE PER MODEL**

BMW								
								
	model	version	c.c.	engine				
15	3-Serie Cabrio (E46)	318 Ci	1995	N42B20A N46B20A				
		320 Cd	1995	M47D20204D4				
		330 Cd	2993	M57D30306D2				
16	3-Serie Cabrio (E93)	320 d	1995	N47D20A N47D20C				
				320 i	1995	N46B20A N46B20B N46B20CC N46B20CD N46B20E N46NB20B		
		325 d	2993			M57D30306D3 N57D30A		
						330 d	2993	M57D30306D3 M57N2306D3 N57D30A
		17	3-Serie Compact (E36)					316 g
						316 i	1596	M43B16164E2
							1895	M43B19194E1
		318 tds	1665	M41D17174T1 M41D18				
		18	3-Serie Compact (E46)	316 ti	1596	M43B16164E3 N40B16A N45B16A		
					1796	N46B18A		
318 td	1995			M47D20204D4				
318 ti	1995			N42B20A N46B20A				
				320 td	1995	M47D20204D4		
19	3-Serie Coupé (E36)	316 i	1596	M43B16164E2				
20	3-Serie Coupé (E46)	316 Ci	1596	M43B16164E3 N45B16A				
				318 Ci	1895	M43B19194E1		
		318 Ci	1995		N42B20A N46B20A			
				320 Cd	1995	M47D20204D4		
		330 Cd	2993	M57D30306D2				

21	3-Serie Coupé (E92)	320 d	1995	N47D20A N47D20C		
				320 xDrive	1995	N47D20C
		320 i	1995	N46B20A N46B20B N46B20CC N46B20CD N46B20E N46NB20B		
				320 xd	1995	N47D20A N47D20C
						325 d
				330 d	2993	
		330 d xDrive	2993			N57D30A
						330 xd
		335 d	2993	M57D30306D5 M57N306D5		
				22	3-Serie Touring (E36)	316 i
318 i	1796	M43B18184E2				
318 tds	1665	M41D17174T1				
325 tds	2497	M51D25256T1				
23	3-Serie Touring (E46)	316 i	1596	N45B16A N42B18A N46B18A		
			1796	N46B18A		
		318 d	1995	M47D20204D4		
		318 i	1895	M43B19194E1		
			1995	N42B20A N46B20A		
		320 d	1995	M47D20204D4		
		330 d	2993	M57D30306D2		
		330 xd	2993	M57D30306D2		



**MOTORI PER MODELLO**

**ENGINE PER MODEL**

<b>BMW</b>										
model	version	c.c.	engine							
<b>24</b>	3-Serie Touring (E91)	316 d	1995	N47D20C	<b>28</b>	4-Serie Cabrio (F33)	420 d	1995	N47D20C	
				M47D20204D4			425 d	1995	N47D20D	
				M47N204D4			430 d	2993	N57D30A	
			318 d	1995	N47D20A	<b>29</b>	4-Serie Coupé (F32)	435 d xDrive	2993	N57D30B
				N47D20C	420 d			1995	N47D20C	
				N47D20C	420 d xDrive			1995	N47D20C	
			318 i	1995	N46B20B			425 d	1995	N47D20D
				N46B20B	430 d			2993	N57D30A	
			320 d	1995	M47D20204D4	430 d xDrive	2993	N57D30A		
				N47D20A	435 d xDrive	2993	N57D30B			
				N47D20C	<b>29</b>	4-Serie Gran Coupé (F36)	418 d	1995	N47D20C	
			320 d ed	1995			N47D20C	420 d	1995	N47D20C
				N47D20A			420 d xDrive	1995	N47D20C	
			320 d xDrive	1995	N47D20A	430 d	2993	N57D30A		
				N47D20C	430 d xDrive	2993	N57D30A			
			320 i	1995	N46B20A	435 d xDrive	2993	N57D30B		
				N46B20C	<b>30</b>	5-Serie (E34)	518 i	1796	M43B18184E2	
			320 xd	1995			N47D20A	525 td	2497	M51D25256T1
			325 d	2993	M57D30306D3	525 tds	2497	M51D25256T1		
				M57N2306D3	<b>31</b>	5-Serie (E39)	525 td	2497	M51D25256T1	
				N57D30A			525 tds	2497	M51D25256T1	
			330 d	2993	M57306D3	<b>32</b>	5-Serie (E60)	520 d	1995	M47D20204D4
				M57D30306D3	520 i			1995	N46B20B	
			330 d	2993	M57N2306D3			525 d	2497	M57D25256D2
		N57D30A	525 d	2993	M57D30306D3					
	330 d xDrive	2993	N57D30A	525 d xDrive	2993			M57306D3		
		M57306D3	525 xd	2993	M57D30306D3					
	330 xd	2993	M57D30306D3	530 d	2993			M57D30306D3		
		N57D30A	530 d xDrive	2993	M57D30306D3					
	335 d	2993	M57D30306D5	535 d	2993			M57D30306D4		
		M57D30306D5	530 xd	2993	M57D30306D3					
	316 d	1995	N47D20C	535 d	2993			M57D30306D5		
	318 d	1995	N47D20C	<b>33</b>	5-Serie (F10)			518 d	1995	N47D20C
	318 d xDrive	1995	N47D20C			520 d	1995	N47D20C		
	320 d	1995	N47D20C			520 d xDrive	1995	N47D20C		
	320 d EfficientDynamics	1995	N47D20C			525 d	1995	N47D20D		
	320 d xDrive	1995	N47D20C			525 d	2993	N57D30A		
	325 d	1995	N47D20D			525 d xDrive	1995	N47D20D		
	325 d xDrive	1995	N47D20D			530 d	2993	N57D30A		
	330 d	2993	N57D30A			530 d xDrive	2993	N57D30A		
	330 d xDrive	2993	N57D30A			535 d	2993	N57D30B		
	335 d xDrive	2993	N57D30B			535 d xDrive	2993	N57D30B		
	318 d	1995	N47D20C							
	320 d	1995	N47D20C							
	320 d xDrive	1995	N47D20C							
<b>26</b>	3-Serie GT (F34)	325 d	1995	N47D20D						
		330 d	2993	N57D30A						
		330 d xDrive	2993	N57D30A						
		335 d xDrive	2993	N57D30B						

**MOTORI PER MODELLO**

**ENGINE PER MODEL**

<b>BMW</b>				
				
	model	version	c.c.	engine
34	5-Serie (G30)	530 d	2993	B57D30A
		530 d xDrive	2993	B57D30A
35	5-Serie Touring (E34)	518 g	1796	M43B18184E2
		518 i	1796	M43B18184E2
		525 td	2497	M51D25256T1
		525 tds	2497	M51D25256T1
36	5-Serie Touring (E39)	525 tds	2497	M51D25256T1
37	5-Serie Touring (E61)	520 d	1995	M47D20204D4
				N47D20A
				N47D20C
		525 d	2497	M57D25256D2
				2993
		525 d xDrive	2993	M57306D3
				M57D30306D3
		525 xd	2993	M57306D3
				M57D30306D3
		530 d	2993	M57306D3
				M57D30306D2
				M57D30306D3
		530 d xDrive	2993	M57N2306D2
				M57306D3
		530 xd	2993	M57D30306D3
				M57306D3
535 d	2993	M57D30306D4		
		M57D30306D5		
38	5-Serie Touring (F11)	518 d	1995	N47D20C
		520 d	1995	N47D20C
		520 d xDrive	1995	N47D20C
		525 d	1995	N47D20D
			2993	N57D30A
		525 d xDrive	1995	N47D20D
		530 d	2993	N57D30A
		530 d xDrive	2993	N57D30A
		535 d	2993	N57D30B
535 d xDrive	2993	N57D30B		
39	5-Serie Touring (G31)	530 d	2993	B57D30A
		530 d xDrive	2993	B57D30A
40	5-Serie (GT) Gran Turismo (F07)	520 d	1995	N47D20C
		530 d	2993	N57D30A
		530 d xDrive	2993	N57D30A
		535 d	2993	N57D30B
		535 d xDrive	2993	N57D30B
41	6-Serie Cabrio (E64)	635 d	2993	M57D30306D5

42	6-Serie Cabrio (F12)	640 d	2993	N57D30B
		640 d xDrive	2993	N57D30B
43	6-Serie Coupé (E63)	635 d	2993	M57D30306D5
44	6-Serie Coupé (F13)	640 d	2993	N57D30B
		640 d xDrive	2993	N57D30B
45	6-Serie Grand Coupé (F06)	640 d	2993	N57D30B
		640 d xDrive	2993	N57D30B
46	7-Serie (E38)	725 tds	2497	M51D25256T1
47	7-Serie (E65-66L)	730 d	2993	M57306D3
				M57D30306D2
				M57D30306D3
48	7-Serie (F01-F02-F03-F04)	730 d	2993	N57D30A
		730 d xDrive	2993	N57D30A
49	7-Serie (G11-G12)	740 d	2993	N57D30B
		740 d xDrive	2993	N57D30B
		730 d	2993	B57D30A
50	X1 (E84)	730 d xDrive	2993	B57D30A
		740 d xDrive	2993	B57D30B
		sDrive 16 d	1995	N47D20C
		sDrive 18 d	1995	N47D20C
		sDrive 18 i	1995	N46B20B
		sDrive 20 d	1995	N47D20C
		xDrive 18 d	1995	N47D20C
		xDrive 20 d	1995	N47D20C
		xDrive 23 d	1995	N47D20C
51	X1 (F48)	xDrive 25 d	1995	N47D20D
52	X3 (E83)	sDrive 16 d	1496	B37C15A
		2.0 d	1995	M47D20204D4
				N47D20A
				N47D20C
		2.0 i	1995	N46B20B
				M57D30306D2
		3.0 d	2993	M57D30306D3
				M57N2306D2
				M57N306D2
		3.0 sd	2993	M57D30306D5
		xDrive 18 d	1995	N47D20C
xDrive 18 d LC1	1995	N47D20C		
xDrive 20 d LC1	1995	N47D20A		
xDrive 20 i LC1	1995	N47D20C		
		N46B20B		
xDrive 30 d LC1	2993	M57D30306D3		
xDrive 35 d LC1	2993	M57N2306D3		
		M57D30306D5		
		M57N306D5		

**MOTORI PER MODELLO**

**ENGINE PER MODEL**



<b>BMW</b>					
model	version	c.c.	engine		
53	X3 (F25)	sDrive 18 d	N47D20C		
		xDrive 20 d	N47D20C		
		xDrive 30 d	N57D30A		
		xDrive 35 d	N57D30B		
54	X4 (F26)	xDrive 30 d	N57D30A		
		xDrive 35 d	N57D30B		
55	X5 (E53)	3.0 d	M57D30306D2 M57N306D2		
		3.0 d	M57D30306D3		
56	X5 (E70)	3.0 sd	M57D30306D5		
		xDrive 30 d	M57306D3 N57D30A		
			xDrive 35 d	M57D30306D5 M57N306D5	
		xDrive 40 d		N57D30B	
		xDrive 50 d	N57D30C		
		57	X5 (F15)	sDrive 25 d	N47D20D
				xDrive 25 d	N47D20D N57D30A
xDrive 30 d	N57D30A				
xDrive 40 d	N57D30B				
58	X6 (E71-E72)			30 d	M57D30306D3 M57N2306D3
		35 d	M57D30306D5		
		xDrive 30 d	M57D30306D3 M57N2306D3		
			N57D30A		
		xDrive 35 d	M57D30306D5		
		xDrive 40 d	N57D30B		
		xDrive 50 d	N57D30C		
		59	X6 (F16)	M 50 d	N57D30C
				xDrive 30 d	N57D30A
				xDrive 40 d	N57D30B
60	Z3 Cabrio (E36)	1.8	M43B18184E2		
		1.9	M43B19194E1		
61	Z4 Cabrio (E85)	2.0 i	N46B20B		

<b>CHEVROLET</b>								
model	version	c.c.	engine					
1	Aveo (T300)	1.2	1229	A12XEL A12XER				
		1.2 GPL	1229	A12XER				
		1.3 D	1248	A13DTCLDV A13DTELSF				
				1.4	1398	A14XER		
		1.4 Turbo	1364	A14NELLUJ A14NET A14NETLUV				
				2	Aveo Sedan (T300)	1.2	1229	A12XEL A12XER
						1.2 GPL	1229	A12XER
		1.3 D	1248	A13DTCLDV A13DTELSF				
1.4	1398			A14XER				
3	Captiva (C100-140)	2.4	2384	A24XE A24XF LE5				
				2.4 4WD	2384	A24XE LE5		
		4	Cruze (J305)	1.4	1398	A14XER LDD		
						5	Cruze Sedan (J300)	1.4
1.4 Turbo	1364	A14NELLUJ A14NET A14NETLUV						
		6	Cruze Station Wagon (J308)	1.4	1398			A14XER LDD
7	HHR	2.4	2399	LE5				
8	Malibu (V300)	2.4	2384	LE9				
9	Orlando (J309)	1.4 Turbo	1364	B14NET				
10	Trax	1.4	1364	A14NELLUJ A14NETLUV				
				1.4 AWD	1364	A14NELLUJ A14NET		
		1.4 GPL	1364	A14NET B14NET				
11	Volt	EV	1398	LUJ				



**MOTORI PER MODELLO**

**ENGINE PER MODEL**

<b>CITROËN</b>				
				
	model	version	c.c.	engine
1	Berlingo Cab.	1.6 HDi	1560	9H03DV6AUTED4
				9HXDV6ATED4
2	Berlingo Multispace (JG)	1.6 HDi	1560	5FSEP6C
				9HSDV6TED4BU
				9HVDV6TED4
		1.6 HDi 4x4	1560	9HXDV6ATED4
				9HZDV6ATED4
1.6 Vti	1598	5FKEP6CB		
3	Berlingo Multispace (MF)	1.6 HDi	1560	9HXDV6ATED4
				9HZDV6ATED4
				DV6ATED4
				DV6B
4	Berlingo Van (II)	1.6 HDi	1560	9H03DV6AUTED4
				9HSDV6TED4BU
				9HTDV6BUTED4
				9HXDV6ATED4
		1.6 Vti	1598	9HZDV6ATED4
				5FKEP6CB
5FSEP6C				
5	Berlingo Van (MB)	1.6 HDi	1560	9HXDV6ATED4
				DV6B
6	C1 (B4)	C1 1.0 e-Vti	998	1KRFE
7	C1 (PM-PN)	1.0	998	1KRFE
8	C2 (JM)	1.6 HDi	1560	9HYDV6TED4
				9HZDV6TED4
9	C3 (FC)	1.4 HDi	1398	8HYDV4TED4
				9HXDV6ATED4
		1.6 HDi	1560	9HYDV6TED4
				9HZDV6TED4
10	C3 (SC)	1.4	1397	8F01EP3C
				8FPEP3
				8FREP3
		1.4 GPL	1397	8FNBP3
				8FNBP3CG
				8FNBP3CG
1.6	1598	5FSEP6C		
		9HXDV6ATED4		
11	C3 Picasso (SH)	1.4	1397	8FNBP3
				8FPEP3
				8FSEP3
				8FNBP3
		1.4 VTi GPL	1397	8FNBP3CG
				8FPEP3
				5FSEP6C
				5FWEP6
1.6	1598	5FSEP6C		
		5FWEP6		
1.6 HDi	1560	9HXDV6ATED4		
		9HXDV6ATED4		

12	C4 (LC)	1.6 HDi	1560	9HZDV6TED4
				5FPEP6
				5FPEP6
13	C4 (NC)	1.6 THP	1598	9HXDV6ATED4
				9HYDV6TED4
				9HZDV6ATED4
		1.6 Vti	1598	DV6ATED4
				5FTEP6DT
				5FXEP6DT
14	C4 Coupé (LA)	1.6 THP	1598	5FWEP6
				RHFDW10BTED4
				RHRDW10BTED4
		1.6 VTi GPL	1598	8F01EP3C
				5FSEP6C
				5FVEP6CDT
15	C4 Sedan (I)	1.6 THP	1598	5FMPE6CDTM
				5FUEP6CDTX
				5GTEP6FDTX
		1.6 Vti	1598	5GYEP6FDTM
				5FSEP6C
				5FSEP6C
16	C4 Grand Picasso (3A-3E)	1.6 HDi	1560	RHEDW10CTED4
				9HXDV6ATED4
				9HYDV6TED4
		1.6 THP	1598	9HZDV6ATED4
				DV6ATED4
				5FXEP6DT
17	C4 Grand Picasso (UA)	1.6 THP	1598	5FWEP6
				RHFDW10BTED4
				RHRDW10BTED4
		1.6 HDi	1560	9HYDV6TED4
				9HZDV6ATED4
				9HZDV6ATED4
2.0 HDi	1997	RHDDW10CTED4		
		5F04EP6CDT		
		5FTEP6DT		
		5FVEP6CDT		
18	C4 Grand Picasso (UA)	1.6 HDi	1560	5FWEP6
				5FXEP6DT
				9HYDV6TED4
				9HZDV6ATED4
		2.0 HDi	1997	RH02DW10CTED4
				RHEDW10CTED4
				RHHDW10CTED4
				RHJDW10BTED4
2.0 HDi	1997	RHRDW10BTED4		
		RHRDW10BTED4		

**MOTORI PER MODELLO**

**ENGINE PER MODEL**

CITROËN				
model	version	c.c.	engine	
18	C4 Picasso (3D)	1.6 THP	1598	5FVEP6CDT
				5FXEP6DT
				5GYEP6FDTM
				5GZEP6FDT
19	C4 Picasso (UD)	1.6	1598	5F04EP6CDT
				5FVEP6CDT
				5FXEP6DT
19	C4 Picasso (UD)	1.6 HDi	1560	9HYDV6TED4 9HZDV6TED4
		1.6 THP	1598	5FTEP6DT
20	C5 (RC)	1.6 Vti	1598	5FWEP6
		2.0 HDi	1997	RH02DW10CTED4 RHEDW10CTED4 RHHDW10CTED4 RHJDW10BTED4 RHRDW10BTED4
21	C5 (RD)	1.6	1598	5F01EP6C
				5FSEPP6C
		1.6 HDi	1560	5FVEP6CDT
				9H01DV6TED4 9HVDV6TED4 9HZDV6TED4
1.6 THP	1598	5FNPP6CDT		
2.0 BlueHdi	1997	RHEDW10CTED4 RH01DW10BTED4 RH02DW10CTED4 RHEDW10CTED4 RHFDW10BTED4 RHHDW10CTED4 RHRDW10BTED4		
22	C5 Break (RE)	1.6 HDi	1560	9HYDV6TED4 9HZDV6TED4
		2.0 HDi	1997	RHLDW10BTED4 RHRDW10BTED4

23	C5 Break (RW)	1.6	1598	5F01EP6C		
				5FSEPP6C		
		1.6 HDi	1560	5FVEP6CDT		
				9H01DV6TED4 9HVDV6TED4 9HZDV6TED4		
1.6 THP	1598	5FNPP6CDT				
24	C8 (EA-EB)	2.0 HDi	1997	RH01DW10BTED4 RH02DW10CTED4 RHEDW10CTED4 RHFDW10BTED4 RHHDW10CTED4 RHRDW10BTED4		
				2.2 HDi	2179	RH02DW10CTED4 RHDDW10CB RHDDW10CTED4 RHEDW10CTED4 RHHDW10CTED4 RHKDW10UTED4 RHRDW10BTED4
						1.4
		1.4 VTi	1397			8F01EP3C
		25	DS3 (SA)	1.4 VTi GPL	1397	8FNEP3CG
				1.6	1598	5FDEP6DTS 5FREP6DT 5FSEPP6C 5FVEP6CDT 5FXEP6DT
1.6 Racing	1598	5FSEPP6DTS				
26	DS3 Cabrio (SB)	1.6	1598	5FMPP6DT 5FNPP6CDT 5FXEP6DT 5GZEP6FDT		
				1.6 THP	1598	5FREP6DT 5FSEPP6C 5FVEP6CDT 5FDEP6DTS 5FNPP6CDT 5FNPP6DT 5GZEP6FDT

**MOTORI PER MODELLO**

**ENGINE PER MODEL**



<b>CITROËN</b>				
model	version	c.c.	engine	
27	DS4 (NX)	1.4 VTi	1397	8FPEP3C
		1.6 THP	1598	5FEFP6CDTMD
				5FUEP6CDTX
				5FVEP6CDT
				5GMEP6FDTX
		2.0 HDi	1997	5GZEP6FDT
				5FSEP6C
2.0 BlueHDi	1997	RHEDW10CTED4		
28	DS5 (KD-KF)	1.6 THP	1598	RHDDW10CTED4
				5GZEP6FDT
				5FEFP6CDTMD
				5FNEP6CDT
		2.0 HDi	1997	5FVEP6CDT
				5GZEP6FDT
				RHDDW10CB
				RHDDW10CTED4
		2.0 HDi	1997	RHEDW10CTED4
				RHFDW10BTED4
2.0 HDi	1997	RHHDW10CTED4		
		RHRDW10BTED4		
2.0 HDi Hybrid4 4x4	1997	RHCDW10CTED4		
29	Jumper Bus (244)	2.2 HDi	2179	4HWDW12TED4
30	Jumper Bus (YAL-B)	2.2 HDi	2198	4HGP22DTE
				4HHP22DTE
				4HJP22DTE
				4HUP22DTE
		3.0 Hdi	2999	4HVP22DTE
F1CE0481DF30DT				
3.0 Hdi	2999	F1CE348IEF30DTE		
31	Jumper Cab. (244)	2.2 HDi	2179	4HWDW12TED4
32	Jumper Cab. (III)	2.2 HDi	2198	4HGP22DTE
				4HHP22DTE
				4HJP22DTE
				4HUP22DTE
		3.0 Hdi	2999	4HVP22DTE
F1CE0481DF30DT				
3.0 Hdi	2999	F1CE348IEF30DTE		
33	Jumper Furg. (244)	2.2 HDi	2179	4HWDW12TED4

34	Jumper Furg. (YAL)	2.2 HDi	2198	4HGP22DTE
				4HHP22DTE
		3.0 Hdi	2999	4HJP22DTE
				4HUP22DTE
				4HVP22DTE
3.0 Hdi	2999	F1CE0481DF30DT		
		F1CE348IEF30DTE		
35	Jumpy Bus (VH)	1.6 HDi	1560	9HUDV6UTED4
				AHYDW10CE
		2.0 HDi	1997	AHZDW10CD
				RH02DW10CTED4
				RHGDW10UTED4
				RHHDW10CTED4
				RHKDW10UTED4
				RHRDW10BTED4
				RHKDW10UTED4
				RHRDW10BTED4
36	Jumpy Cab. (ZA)	2.0 HDi	1997	RHKDW10UTED4
37	Jumpy Furg. (XA)	1.6 HDi	1560	9HUDV6UTED4
				AHYDW10CE
		2.0 HDi	1997	AHZDW10CD
				RH02DW10CTED4
				RHHDW10CTED4
				RHKDW10UTED4
2.0 HDi 4x4	1997	RHRDW10BTED4		
		AHZDW10CD		
38	Nemo Multispace (AA)	1.3 HDi	1248	FHYF13DTE6
39	Nemo VAN (AA)	1.3 BlueHDi	1248	FHZF13DTE5
				FHYF13DTE6
39	Nemo VAN (AA)	1.3 HDi	1248	FHZF13DTE5
				FHYF13DTE6
40	Relay Bus (244)	2.2 HDi	2179	4HWDW12TED4
41	Relay Bus (YAL-B)	2.2 HDi	2198	4HGP22DTE
				4HHP22DTE
				4HJP22DTE
				4HUP22DTE
		3.0 Hdi	2999	4HVP22DTE
F1CE0481DF30DT				
3.0 Hdi	2999	F1CE348IEF30DTE		
42	Relay Cab. (244)	2.2 HDi	2179	4HWDW12TED4
43	Relay Cab. (III)	2.2 HDi	2198	4HGP22DTE
				4HHP22DTE
				4HJP22DTE
				4HUP22DTE
		3.0 Hdi	2999	4HVP22DTE
				F1CE0481DF30DT
3.0 Hdi	2999	F1CE348IEF30DTE		
44	Relay Furg. (244)	2.2 HDi	2179	4HWDW12TED4



**MOTORI PER MODELLO**

**ENGINE PER MODEL**



**CITROËN**

						
model	version	c.c.	engine			
45	Relay Furg. (YAL)	2.2 HDi	2198	4HGP22DTE		
			4HHP22DTE			
			4HJP22DTE			
			4HUP22DTE			
			4HVP22DTE			
	3.0 Hdi	2999	F1CE0481DF30DT			
		F1CE348IEF30DTE				
		46	Xsara Picasso (N68)	1.6 HDi	1560	9HXDV6ATED4
					9HYDV6TED4	
					9HZDV6TED4	

**DAIHATSU**

				
model	version	c.c.	engine	
1	Cuore (L276)	1.0	998	1KRFE
2	Sirion (M3)	1.0	998	1KRFE
3	Storia	1.0	998	1KRFE

**FIAT**

				
model	version	c.c.	engine	
1	125	1608	125A000	
2	126	600	594	126A000
		650	652	126A1000
				126A1048
		700	704	126A2000
				126A2048
3	127	PRIMA SERIE	903	100GL
4	1300		1295	115A000
5	1500		1481	115A000
6	500	PRIMA SERIE	479	110000
7	500 (312)	0.9	875	312A2000
			964	312A4000
		0.9 Twin Air	875	312A5000
			964	312A4000
			312A6000	
		0.9 TwinAir Turbo	875	199B6000
		1.3 D Multijet	1248	169A1000
			312B5000	
		1.3 Multijet	1248	199B1000

8	500C (312)	0.9	875	312A2000		
			964	312A5000		
			312A4000			
		312A6000				
		0.9 TwinAir Turbo	875	199B6000		
		1.3 D Multijet	1248	169A1000		
9	500L (199)	0.9	875	199B6000		
			312A2000			
		0.9 CNG	875	312A2000		
		0.9 Natural Power	875	312A2000		
10	500X (5F)	1.3 D Multijet	1248	199B4000		
			330A1000			
11	600	1.3 D Multijet	1248	55266963		
12	850		633	100		
13	900 Furgone, 900 Panorama		843	100D000		
14	Croma (194A)	2.2	2198	194A1000		
				1.3 JTD	1248	188A9000
				1.3 Multijet	1248	199A2000
15	Doblò (119)	1.3 Multijet	1248	223A9000		
			1.3 D Multijet	1248	330A1000	
16	Doblò Cab. (263)	1.3 Multijet	1248	199A3000		
			263A2000			
			263A6000			
17	Doblò Cargo (223A-W-Z)	1.3 JTD	1248	188A8000		
			188A9000			
		1.3 Multijet	1248	199A2000		
			223A9000			
18	Doblò Cargo (263)	1.3 D Multijet	1248	225A2000		
			330A1000			
		1.3 Multijet	1248	199A3000		
			263A2000			
19	Doblò Combi (152)	1.3 Multijet	1248	263A6000		
			199A3000			
20	Ducato Bus (250A)	2.2 D Multijet	2198	4HV		
			F1CE0481D			
		3.0 D Multijet	2999	F1CE3481E		
			F1CE0481D			
		3.0 D Multijet Power	2999	F1CE3481M		
			F1CE3481N			
		3.0 Natural Power	2998	F1CE0441A		
			2999	F1CFA401A		
21	Ducato Bus (290)	3.0 Multijet Power	2999	F1CE3481E		
			3.0 Natural Power	2999	F1CFA401A	

**MOTORI PER MODELLO**

**ENGINE PER MODEL**

FIAT				
model	version	c.c.	engine	
22	Ducato Cab. (250B)	2.2 D Multijet	2198	4HV
		3.0 D Multijet	2999	F1CE3481E
				F1CE3481M
		3.0 D Multijet Power	2999	F1CE0481D
		3.0 Natural Power	2998	F1CE3481N
2999	F1CE0441A			
23	Ducato Cab. (290)	3.0 Multijet Power	2999	F1CE3481E
		3.0 Natural Power	2999	F1CFA401A
24	Ducato Furg. (250A)	2.2 D Multijet	2198	4HV
		3.0 D Multijet	2999	F1CE3481E
				F1CE3481M
3.0 D Multijet Power	2999	F1CE0481D		
24	Ducato Furg. (250A)	3.0 Natural Power	2998	F1CE0441A
			2999	F1CFA401A
25	Ducato Furg. (290)	3.0 Multijet Power	2999	F1CE3481E
		3.0 Natural Power	2999	F1CFA401A
26	Fiorino Furg. (225B)	1.3 D Multijet	1248	199A2000
				199A9000
				199B1000
				225A2000
				330A1000
27	Grande Punto (199A)	1.3 Multijet	1248	199B2000
				199B4000
				223A9000
28	Idea (350A)	1.3 Multijet	1248	188A9000
				199A3000
				199B1000
29	Palio (171)	1.3 JTD	1248	188A9000
30	Palio (178BX)	1.3 JTD Multijet	1248	188A9000
31	Panda (169A)	1.3 Multijet	1248	169A1000
				169A5000
				188A8000
				188A9000
		1.3 Multijet 4x4	1248	169A1000
				169A5000
				188A8000
				188A9000

32	Panda (319)	0.9	875	312A2000		
			964	312A7000		
		0.9 4x4	875	312A4000		
				312A6000		
		0.9 CNG	875	312A2000		
		0.9 Natural Power	875	312A2000		
		0.9 TwinAir	875	312A5000		
				312A7000		
		33	Panda Van (169)	1.3 D Multijet	1248	199A9000
						225A2000
312A8000						
312B1000						
1.3 D Multijet 4x4	1248			312B2000		
				330A1000		
				199A9000		
				225A2000		
34	Panda Van (519)	1.3 Multijet	1248	312A8000		
				312B1000		
		1.3 Multijet 4x4	1248	312B2000		
				330A1000		
35	Panda (141A)	0.9	875	169A1000		
			964	188A8000		
		0.9 4x4	875	188A9000		
				169A1000		
		0.9 Natural Power	875	188A8000		
		0.9 TwinAir Turbo	875	188A9000		
		36	Panda van (141A)	1.3 D Multijet	1248	169A1000
						188A8000
				1.3 D Multijet 4x4	1248	199A9000
						225A2000
37	Punto (188A)	1.3 Multijet	1248	312A2000		



**MOTORI PER MODELLO**



**ENGINE PER MODEL**

FIAT												
model	version	c.c.	engine									
38	Punto EVO (199J)	1.3 D Multijet	1248	199A2000	44	Scudo Bus (270)	1.6 D Multijet	1560	9H07DV6UC			
			199A3000	9HM								
			199A9000	9HU								
		1.3 Multijet	1248	199A2000			DV6UC9HM					
			199A3000	199A9000			DV6UTED4					
			199B1000	199B2000			DW10BTED4					
	Punto EVO-VAN (199)	1.3 Multijet	1248	199B4000		DW10UTED4	45	Scudo Cab. (270)	2.0 D Multijet	1997	RH02	
				223A9000		RHH						
				199A2000		RHK						
		1.3 Multijet	1248	199A3000		199A9000			RHR	2.0 HDi	1997	RHK
				199B1000		199B2000			RH02			
				199B4000		223A9000			1.6 D Multijet			1560
40	Punto MY-2012 (199)	0.9 Bifuel	875	312A2000	46	Scudo Furg. (270)	2.0 D Multijet	1997	9H07DV6UC			
				199B6000					9HM			
				199B6000					9HU			
		0.9 TwinAir	875	312A2000			DV6UC9HM					
				199B6000			DV6UTED4					
				199B6000			DW10BTED4					
	0.9 TwinAir Turbo	875	312A2000	199B6000		DW10UTED4	2.0 Multijet Power	1997	RH02			
			199B6000	199B6000		RHH						
			199B6000	199B6000		RHK						
	Punto Van (188AX)	1.3 JTD	1248	188A9000		1.6 D Multijet	1560	47	Sedici (189)	1.6	1586	M16A
				199A2000		2.0 D Multijet	1997				9H07DV6UC	
				199A9000						9HM		
199B4000		9HU										
Punto Van (199)		1.3 Multijet	1248	199A2000	DV6UC9HM	48	Siena (178B)		1.3 JTD Multijet	1248	188A9000	
				199A9000	DV6UTED4							
	199B1000			DW10BTED4								
	1.3 Multijet	1248	199B4000	199B1000	DW10UTED4		49	Strada Pick up (178E)	1.3 D Multijet	1248	199B1000	
			199B8000	199B1000	223A9000							
			199B8000	199B1000	223A9000							
Punto Van (188AX)	1.3 JTD	1248	188A9000	1.6 D Multijet	1560	50	Tipo (MY2016)	1.3 Multijet	1248	55266963		
			199A2000	2.0 HDi	1997					9H07DV6UC		
			199A9000							9HM		
	199B4000	9HU										
	Punto Van (199)	1.3 Multijet	1248	199A2000	DV6UC9HM		51	Tipo Sedan (MY2016)	1.3 Multijet	1248	55266963	
				199A9000	DV6UTED4							
199B1000				DW10BTED4								
1.3 Multijet		1248	199B4000	199B1000	DW10UTED4	52		Tipo Sedan (MY2016)	1.3 Multijet	1248	55266963	
			199B8000	199B1000	223A9000							
			199B8000	199B1000	223A9000							
Qubo Multispace (225)	1.3 D Multijet	1248	199A2000	1.6 D Multijet	1560	53	Tipo Sedan (MY2016)	1.3 Multijet	1248	55266963		
			199A9000	2.0 HDi	1997					9H07DV6UC		
			199B1000							9HM		
	225A2000	9HU										
	1.3 D Multijet	1248	199B1000	199B1000	DV6UC9HM		54	Tipo Sedan (MY2016)	1.3 Multijet	1248	55266963	
			225A2000	DV6UTED4								
225A2000			DW10BTED4									

**MOTORI PER MODELLO**

**ENGINE PER MODEL**

FIAT				
				
	model	version	c.c.	engine
52	Tipo Station Wagon (MY2016)	1.3 Multijet	1248	55266963
53	Ulysse (179AX)	2.0 D Multijet	1997	RHK
				RHR
		2.0 JTD	1997	RHMDW10ATED4
				RHT
		2.2 JTD	2179	RHWDW10ATED4
54	Ulysse (220A)	2.0 JTD	1997	RHWDW10ATED4
55	Uno	45	903	100GL

FORD				
				
	model	version	c.c.	engine
1	C-Max (EMW)	1.6 TDCi	1560	G8DA
				G8DB
				G8DC
				G8DD
				GPDA
				HHDA
				HHDB
				MTDA
				QQDA
				QQDB
				QQDC
				AODA
		AODB		
		AODE		
		SYDA		
		2.0 TDCi	1997	G6DA
				G6DB
				G6DC
				G6DD
				G6DE
				G6DF
		G6DG		
		IXDA		
		2.0 TDCi Duratorq	1997	UFDA
2	C-Max (II)	2.0 TDCi	1997	TXDA
				TXDB
				TYDA
				UFDA
				UFDB
				UKDB

3	C-Max Van (II)	2.0 TDCi	1997	TXDB
				TYDA
				UFDB
4	Ecosport	2.0	1999	AOJB
5	Fiesta (AJ)	1.6 TDCi	1560	HHJC
				HHJD
				HHJE
				HHJF
				T3JA
				TZJA
				TZJB
UBJA				
6	Fiesta (GFBT)	0.9	957	TKA
				TKW
		1.1	1117	TLA
				GLA
7	Fiesta (JA-JB)	1.8 DI	1753	GLW
				RTN
				RTP
8	Fiesta (JH-JD)	1.3	1299	RTQ
				A9JA
		1.6 TDCi	1560	A9JB
9	Fiesta Sedan	1.6 TDCi	1560	BAJA
				HHJA
10	Fiesta Van (AJ)	1.6 TDCi	1560	HHJB
				HHJC
				HHJD
				HHJE
				T3JA
				TZJA
11	Fiesta Van (JH)	1.3	1299	TZJB
				A9JA
		1.6 TDCi Duratorq	1560	A9JB
12	Fiesta Van (JV)	1.8 TD	1753	HHJA
				HHJB
				RTN
				RTP
				RTQ

**MOTORI PER MODELLO**

**ENGINE PER MODEL**

FORD													
model	version	c.c.	engine										
13	Focus (I DAW-DBW)	1.8 TDCi	F9DA	16	Focus Cabrio (II DA2)	2.0	1999	AODA					
			F9DB					AODB					
			FFDA					G6DA					
		1.8 TDDi	1753			BHDA	2.0 TDCi	1997	G6DB				
						BHDB			G6DD				
						C9DA			F9DA				
	1.8 Turbo TDDi	1753	C9DB		17	Focus Sedan (DFW)	1.8 TDCi	1753	F9DB				
			C9DC						FFDA				
			C9DE						BHDA				
			1.6 TDCi				1560	G8DA	18	Focus Sedan (II DA4-H)	1.8 Turbo TDDi	1753	BHDB
								G8DB					C9DA
								G8DC					C9DB
14	Focus (II DA3-G)	1.8		1798	18	Focus Sedan (II DA4-H)		1.6 TDCi			1560	C9DC	
												1.8 TDCi	1753
		1.8		1798									
			Q7DA				G8DC						
		1.8 TDCi	1753	Q7DA			G8DD						
				Q7DA			G8DE						
	2.0	1999	1999	AODA			G8DF						
				AODB			GPDA						
				AODE			GPDB						
				SYDA			GPDC						
				2.0 TDCi			1997	1997	G6DA	HHDA			
									G6DB	HHDB			
G6DC	MTDA												
G6DD	Q7DA												
G6DE	Q7DA												
G6DF	Q7DA												
15	Focus (III)	2.0 Duratorq	1998	19	Focus Sedan (III)	2.0 Duratorq	1998	G6DA					
								G6DB	G6DA				
								G6DC	G6DB				
								G6DD	G6DC				
								G6DE	G6DD				
								G6DF	G6DE				
	2.0 TDCi	1997	1997		IXDA	G6DA							
					IXDA	G6DB							
					T7DA	G6DC							
					T7DB	G6DD							
					T8DA	G6DE							
					T8DA	G6DF							
2.0 TDCi	1997	1997	TXDB	G6DA									
			TXDB	G6DB									
			TYDA	G6DC									
			UFDB	G6DD									
			UKDB	G6DE									
			UKDB	G6DF									



**MOTORI PER MODELLO**



**ENGINE PER MODEL**

FORD						
model	version	c.c.	engine			
20	Focus Turnier (DNW)	1.8 TDCi	F9DA			
			F9DB			
			FFDA			
		1.8 TDDi	BHDA			
			BHDB			
			C9DA			
	1.8 Turbo TDDi	1753	C9DB			
			C9DC			
			21	Focus Turnier (II DAW)	1.6 TDCi	G8DA
						G8DB
						G8DC
						G8DD
G8DE						
G8DF						
GPDA						
GPDC						
HHDA						
HHDB						
MTDA						
1.6 TDCi Duratorq	1560	G8DA				
1.8	1798	Q7DA				
		QQDB				
1.8 TDCi	1753	KKDA				
		KKDB				
2.0	1999	AODA				
		AODB				
		AODE				
2.0 TDCi	1997	G6DA				
		G6DB				
		G6DC				
		G6DD				
		G6DE				
		G6DF				
22	Focus Turnier (III)	2.0 Duratorq	T7DB			
			T8DA			
			TXDB			
		2.0 TDCi	1997	TYDA		
				UFDB		
				UKDB		

23	Focus Van (III)	2.0 Duratorq	1998	T7DB
		2.0 TDCi	1997	T7DB
24	Focus C-Max (DMW)	1.6 TDCi	1560	G8DA
				G8DB
				G8DC
				HHDA
				HHDB
				CSDA
		1.8	1798	CSDB
				Q7DA
				QQDA
				QQDB
				QQDC
				KKDA
1.8 TDCi	1753	AODA		
		AODB		
2.0	1999	SYDA		
		G6DA		
2.0 TDCi	1997	G6DB		
		G6DC		
		G6DD		
		G6DE		
		G6DF		
		G6DG		
2.0 TDCi Duratorq	1997	UFDA		
		BAJA		
25	Fusion (JU)	1.3	1299	HHJA
		1.6 TDCi	1560	HHJB
26	Galaxy (SWG)	1.8 TDCi	1753	FFWA
				QYWA
				AOWA
		2.0	1999	AOWB
				TNBA
				TNWA
		2.0 SCTI	1999	TNWB
				TPBA
				AZWA
		2.0 TDCi	1997	AZWC
				KLWA
				QXWA
QXWB				
QXWC				
TXWA				
2.0 TDCi	1997	TYWA		
		UFWA		
		UKWA		

**MOTORI PER MODELLO**

**ENGINE PER MODEL**

FORD				
				
	model	version	c.c.	engine
27	Grand C-max (CB7)	2.0 TDCi	1997	TXDA
				TXDB
				TYDA
				UFDB
				UKDB
28	Grand C-max Van	2.0 TDCi	1997	TXDB
				TYDA
				UFDB
29	Ka (RB)	1.3 i	1299	A9A
				A9B
		1.6 i	1599	CDB
				CDC
		SportKa 1.6 Duratec	1599	CDB
CDC				
30	Ka (RU)	1.3 TDCi	1248	FD4
				CDB
		1.6	1598	CDC
31	Kuga (RDR)	2.0 TDCi	1997	G6DG
				UFDA
				UKDA
		2.0 TDCi 4x4	1997	G6DG
				TXDA
UFDA				
UKDA				
32	Maverick (NU)	2.3	2261	GZ
33	Mondeo (B5Y)	2.0	1999	CJBA
				CJBB
				D6BA
		2.0 TDCi	1998	FMBA
				FMBB
				HJBA
				HJBB
				HJBC
				N7BA
				D5BA
		2.0 TDDi	1998	D6BA
				HJBA
				HJBB
HJBC				

34	Mondeo (BA7)	1.8 TDCi	1753	FFBA
				KHBA
				QYBA
		2.0	1999	AOBA
				AOBC
				TBBA
				TNBA
		2.0 SCTi	1976	TNBB
			1999	TPBA
		35	Mondeo Sedan (B4Y)	2.0 TDCi
AZBC				
KLBA				
LPBA				
QXBA				
QXBB				
TXBA				
TXBB				
TYBA				
UFBA				
UFBB				
UKBA				
UKBB				
36	Mondeo Sedan (B4Y)	2.0	1999	CJBA
				CJBB
		2.0 TDCi	1998	D6BA
				FMBA
				FMBB
				HJBA
				HJBB
				HJBC
				N7BA
		2.0 TDDi	1998	D5BA
D6BA				
HJBA				
HJBB				
HJBC				
1.8 TDCi	1753	FFBA		
		KHBA		

**MOTORI PER MODELLO**

**ENGINE PER MODEL**

<b>FORD</b>					
model	version	c.c.	engine		
36	Mondeo Sedan (BA7)	1.8 TDCi	1753	QYBA	
		2.0	1999	AOBA AOBC TBBA TNBA TNBB TPBA	
	2.0 SCTI	1999	AZBA AZBC KLBA LPBA QXBA QXBB TXBA TXBB TYBA UFBA UFBB UKBA UKBB		
	2.0 TDCi	1997	FFBA KHBA QYBA AOBA AOBC TBBA TNBA TNBB TPBA AZBA AZBC KLBA LPBA QXBA QXBB TXBA TXBB TYBA UFBA UFBB UKBA UKBB		
	37	Mondeo Turnier (BA7)	1.8 TDCi	1753	QYBA
			2.0	1999	AOBA AOBC TBBA TNBA TNBB TPBA
			2.0 SCTI	1976	TNBA
			2.0 SCTI	1999	TNBB TPBA
			2.0 TDCi	1997	AZBA AZBC KLBA LPBA QXBA QXBB TXBA TXBB TYBA UFBA UFBB UKBA UKBB

38	Mondeo Turnier (BWY)	2.0	1999	CJBA CJBB D6BA FMBA FMBB HJBA HJBB HJBC N7BA				
		2.0 TDCi	1998	D5BA D6BA HJBA HJBB HJBC				
		2.0 TDDi	1998	JBB JLA JLB				
		39	Orion (II)	1.3	1297	GBVAJPF GBVAJQJ GBVAJQW Q2JSGBVAJQJ		
				2.2 TDCi	2198	GBVAJQJ GBVAJQW Q2JSGBVAJQJ		
				2.2 TDCi 4x4	2198	FFWA QYWA AOWA AOWB		
				40	Ranger (III)	2.2 TDCi	2198	TNBA TNWA TNWB TPBA TPWA
		2.2 TDCi 4x4	2198			AZWA AZWC KLWA QXWA QXWB QXWC TXWA TYWA UFWA UKWA		
		41	S-Max (I SWS)			1.8 TDCi	1753	CDB
						2.0	1999	CDC
2.0 SCTI	1999					CDRB		
2.0 TDCi	1997							
42	Street-Ka (LWD)					1.6	1599	

**MOTORI PER MODELLO**

**ENGINE PER MODEL**

FORD				
model	version	c.c.	engine	
43	Torneo Custom Bus	2.2 TDCi	2198	CVFF
				CYF4
				CYFF
				DRF4
				DRFF
				DRFG
45	Tourneo (JXXT)	2.2 TDCi	2198	CYFA
				CYFB
				DRFA
				PGFA
				PGFB
				QVFA
				QWFA
				SRFA
				SRFB
				SRFC
				SRFD
				SRFE
				UHFA
				UHFB
46	Transit Bus	2.2 TDCi 4WD	2198	CY24
				CYR5
		2.2 TDCi Duratorq	2198	CVFF
				CYFF
				UHR5
		2.2 TDCi FWD	2198	CVF5
				CY14
				CYF5
				CYFG
				DRF5
				DRFF
		DRFG		
		2.2 TDCi RWD	2198	CV24
				CVR5
DRR5				
USR6				
UYR6				

47	Transit Bus (FD-B-S-C)	2.0 DI	1998	ABFA		
				D3FA		
				F3FA		
				2.0 TDCi	1998	FIFA
				2.4 DI	2402	D2FA
						D2FB
		D2FE				
		D4FA				
		F4FA				
		F4FA				
		2.4 TD	2402	F4FA		
				F4FA		
		2.4 TDCi	2402	H9FA		
				D2FE		
2.4 TDdi	2402	D4FA				
		HFFA				
2.4 TDDi Duratorq	2402	DOFA				
		FXFA				
2.4 TDE	2402					

**MOTORI PER MODELLO**

**ENGINE PER MODEL**

FORD										
model	version	c.c.	engine							
48	Transit Bus (HXXT)	2.2 TDCi	2198	P8FA	49	Transit Cab.	2.2 TDCi 4WD	2198	CV24	
				P8FB					CVR5	
				PGFA					CY24	
				PGFB					CYR5	
				QVFA			2.2 TDCi Duratorq	2198	CVFF	
				QWFA					CYFF	
				SRFA					UHR5	
				SRFB					CVF5	
				SRFC			2.2 TDCi FWD	2198	CYF5	
				SRFD					DRF5	
				SRFE					DRFF	
				UHFA					DRFG	
				UHFB			2.2 TDCi RWD	2198	CV24	
				UHFC					CVR5	
				CYFA					DRR5	
				CYFB					USR6	
	49	Transit Cab. (AX-BX)	2.2 TDCi	2198	CYFC	50	Transit Cab. (AX-BX)	2.2 TDCi	2198	CYFD
					CYFC					DRFA
					CYFD					DRFB
					DRFA					DRFC
					DRFB					DRFD
					DRFC					DRFE
					DRFD					P8FA
					DRFE					P8FB
					CYRA					PGFA
					CYRB					PGFB
					DRRA					QVFA
					DRRB					QWFA
					DRRC					SRFA
					USRA					SRFB
					USRB					SRFC
					H9FD					SRFD
JXFA	SRFE									
JXFC	UHFA									
PHFA	UHFB									
PHFC	UHFC									
50	Transit Cab. (HXXT)	2.4 TDCi	2402	H9FB	50	Transit Cab. (HXXT)	2.2 TDCi 4x4	2198	CYRB	
				H9FA					CYRC	
				H9FA						

**MOTORI PER MODELLO**

**ENGINE PER MODEL**

FORD							
model	version	c.c.	engine				
50	Transit Cab. (AX-BX)	2.2 TDCi RWD	CVRA	2198	52	Transit Furg.	CV24
			CVRB				CVR5
			CVRC				CY24
			CYRA				CYR5
			CYRB				CVFF
			DRRA				CYFF
			DRRB				UHR5
			DRRC				CVF5
			GZFA				CY14
			GZFB				CYF5
		GZFC	CYFG				
		2.4 TDCi	H9FB	2198	CV24		
			H9FD		CVR5		
			JXFA		DRR5		
			JXFC		UHR5		
			PHFA		USR6		
			PHFC		UYR6		
		2.4 TDCi Allrad	2402	H9FB	ABFA		
		2.4 TDCi Duratorq	2402	H9FA	D3FA		
		2.0 DI	1998	ABFA	F3FA		
D3FA	FIFA						
F3FA	D2FA						
2.0 TDCi	1998	FIFA	D2FB				
		D2FA	D2FE				
2.4 DI	2402	D2FB	D4FA				
		D2FE	F4FA				
		D4FA	F4FA				
		F4FA	H9FA				
		H9FA	D4FA				
2.4 TDCi	2402	H9FA	F4FA				
2.4 TDdi	2402	D4FA	F4FA				
2.4 TDDi Duratorq	2402	HFFA	HFFA				
2.4 TDE	2402	DOFA	DOFA				
		FXFA	FXFA				
51	Transit Cab. (FM-N)	2.0 DI	ABFA	1998	53	Transit Furg. (FA-E-C)	2.0 DI
			D3FA				2.0 TDCi
			F3FA				2.0 TDCi
		2.4 DI	2402	D2FA			2.4 DI
				D2FB			2.4 DI
				D2FE			2.4 DI
				D4FA			2.4 TD 4x4
				F4FA			2.4 TDCi
		2.4 TDCi	2402	H9FA			2.4 TDdi
		2.4 TDdi	2402	D4FA			2.4 TDdi
		2.4 TDDi Duratorq	2402	HFFA			2.4 TDDi Duratorq
		2.4 TDE	2402	DOFA			2.4 TDE
				FXFA			2.4 TDE

**MOTORI PER MODELLO**

**ENGINE PER MODEL**



<b>FORD</b>						
model	version	c.c.	engine			
54	Transit Furg. (MXXT)	2.2 TDCi	2198	P8FA		
				P8FB		
				QVFA		
				QWFA		
				SRFA		
				SRFB		
				SRFC		
				SRFD		
				SRFE		
				UHFA		
				UHFB		
				UHFC		
				2.2 TDCi AWD	2198	CYRB
						CYRC
				2.2 TDCi Duratorq	2198	USRA
	2.2 TDCi FWD	2198	CYFA			
			CYFB			
			CYFC			
			CYFD			
			DRFA			
			DRFB			
			DRFC			
			DRFD			
			DRFE			
			2.2 TDCi RWD	2198	CVRA	
	CVRB					
	CVRC					
	CYRA					
	CYRB					
	DRRA					
	DRRB					
	DRRC					
	2.3	2295			GZFA	
GZFB						
GZFC						
2.4 TDCi	2402	H9FD				
		JXFA				
		JXFC				
		PHFA				
		PHFC				
2.4 TDCi Allrad	2402	H9FB				
2.4 TDCi Duratorq	2402	H9FA				



55	Transit Connect (P65)	1.8 DI	1753	BHPA
				P7PA
				P7PB
				R2PA
				HCPA
		1.8 TDCi	1753	HCPB
				P9PA
				P9PB
				P9PC
				P9PD
				R3PA
				RWPA
				RWPC
				RWPD
				RWPE
56	Transit Custom	2.2 TDCi	2198	RWPB
				RWPF
				CVFF
				CYF4
				CYFF
57	Transit Custom Kombi	2.2 TDCi	2198	DRF4
				DRFF
				DRFG
				CVFF
				CYF4
58	Transit Custom Kombi	2.2 TDCi	2198	CYFF
				DRF4
				DRFF
				DRFG
				DRFG

<b>HYUNDAI</b>				
model	version	c.c.	engine	
1	Accent (MC)	1.5 CRDi GLS	1493	D4FA
2	Accent (RB)	1.6 CRDi	1582	D4FB
3	Accent Sedan (MC)	1.5 CRDi GLS	1493	D4FA
4	Accent Sedan (RB)	1.5 D	1493	D4FA
		1.6 CRDi	1582	D4FB
		1.6 TCI-UII	1582	D4FB
5	Bus Bus	150	2497	D4CB
		170	2497	D4CB
6	Elantra (MD-UD)	1.6 CRDi	1582	D4FB
7	Elantra Sedan (HD)	1.6 CRDi	1582	D4FB
8	Elantra Sedan (XD)	1.6 CRDi	1582	D4FB
9	Getz (TB)	1.5 CRDi	1493	D4FA
		1.5 CRDi GLS	1493	D4FA
10	H-1 Cab.	2.5 CRDi	2497	D4CB

**MOTORI PER MODELLO**

**ENGINE PER MODEL**

<b>HYUNDAI</b>				
				
	model	version	c.c.	engine
11	H-1 Cargo (KFM)	2.5 CRDi	2497	D4CB
				D4CBL
				D4CBW
12	H-1 Furg. (KFM)	2.5 CRDi	2497	D4CB
13	H-1 Travel (KM)	2.5 CRDi	2497	D4CB
14	H-100 Cab. (III)	2.5 CRDi	2497	D4CB
15	H350 Cab.	150	2497	D4CB
		170	2497	D4CB
16	H350 Furg.	170	2497	D4CB
		2.5 CRDi	2497	D4CB
17	i10 (PA)	1.1 CRDi	1120	D3FA
18	i20 (PB-PBT)	1.1 CRDi	1120	D3FA
		1.4 CRDi	1396	D4FC
		1.6 CRDi	1582	D4FB
19	i30 (DC)	1.6 CRDi	1582	D4FB
		1.4 CRDi	1396	D4FC
20	i30 (GD)	1.6 CRDi	1582	D4FB
		1.4 CRDi	1396	D4FC
21	i30 Coupé	1.6 CRDi	1582	D4FB
		1.4 CRDi	1396	D4FC
22	i30 Station wagon (CW)	1.4 CRDi	1396	D4FC
		1.6 CRDi	1582	D4FB
23	i30 Station wagon (DC-CD)	1.6 CRDi	1582	D4FB
				D4FB5P
24	i40 (VF)	1.7 CRDi	1685	D4FD
25	i40 Station Wagon (VF)	1.7 CRDi	1685	D4FD
26	ix20 (JC)	1.4 CRDi	1396	D4FC
				D4FCM
27	ix35 (LM)	1.6 CRDi	1582	D4FB
		1.7 CRDi	1685	D4FD
28	Matrix (FC)	1.5 CRDi	1493	D4FA
		1.5 CRDi VGT	1493	D4FA
29	Porter Furg. (II)	2.5 CRDi	2497	D4CB

<b>IVECO</b>				
				
	model	version	c.c.	engine
1	Campagnola	3.0 HPI	2998	F1CE0481FA
		3.0 HPT	2998	F1CE0481HA
2	Daily Bus (III)	35 S 14. 50 C 14	2998	F1CE0481A
		35S12	2287	F1AE0481B
		40 C 17. 50 C 17	2998	F1CE0481B

3	Daily Bus (IV)	35S14	2287	F1AE0481HA
		35S14 G	2998	F1CE0441A
		35S15	2998	F1CE0481B
		35S17	2998	F1CE3481C
		35S18	2998	F1CE0481HC
		35S18W	2998	F1CE0481HC
		40C14 G	2998	F1CE0441A
		40C15	2998	F1CE0481B
				F1CE0481L
		40C17	2998	F1CE3481C
		40C18	2998	F1CE0481HC
		50C14 G	2998	F1CE0441A
		50C15	2998	F1CE0481B
				F1CE0481L
		50C17	2998	F1CE3481C
		50C18	2998	F1CE0481HC
4	Daily Bus (MY2014)	33S11D. 33S11V. 30S11 2.3 HPT	2286	F1AFL411A
		33S13D. 33S13SV 2.3 HPT	2286	F1AFL411B
		35S15D. 35S15SV 2.3 HPT	2286	F1AFL411C
5	Daily Cab. (III)	29L10	2287	F1AE0481A
		29L12	2287	F1AE0481B
		29L14	2287	F1AE0481M
		35 C 10	2287	F1AE0481A
		35 C 12	2287	F1AE0481B
		35 C 14	2998	F1CE0481A
		35 C/S 14	2287	F1AE0481M
		35 C/S 17	2998	F1CE0481B
		40 C 10	2287	F1AE0481A
				F1AE0481M
		40 C 14	2998	F1CE0481A
				F1CE0481B
40 C/S 17	2998	F1CE0481B		
50 C 14	2998	F1CE0481A		
50 C 17	2998	F1CE0481B		
65 C 14	2998	F1CE0481A		
65 C 17	2998	F1CE0481B		



**MOTORI PER MODELLO**

**ENGINE PER MODEL**

IVECO				
model	version	c.c.	engine	
6	Daily Cab. (IV)	29L10	2287 F1AE0481FA	
		29L12	2287 F1AE0481GA	
		29L14	2287 F1AE0481HA	
		35C11 35S11	2287	F1AE0481FA
				F1AE0481UA
				F1AE0481UB
		35C12	2287	F1AE0481FA
				F1AE0481GA
		35C13 35S13	2287	F1AE0481GA
				F1AE0481V
				F1AE0481VA
				F1AE0481VB
		35C14 35S14	2998	F1CE3481LC
		35C14 G 35C14 G/P 35S14 G 35S14 G/P 35C14 GD 35S14 GD	2998	F1CE0441A
		35C15	2998	F1CE0481FA
		35C17 35C17 /P 35S17 35S17 /P 35S17 D	2998	F1CE0481HA
		35C17 W 35S17 W	2998	F1CE0481HA
				F1CE3481CA
		35C18	2998	F1CE0481HA
		35S14	2287	F1AE0481HA
		35S18 W	2998	F1CE0481HC
		40C10	2287	F1AE0481FA
		40C11	2287	F1AE0481FA
				F1AE0481UA
				F1AE0481UB
		40C12	2287	F1AE0481GA
		40C13	2287	F1AE0481GA
				F1AE0481VA
F1AE0481VB				
40C14 40C14 /P 40S14 40S14 /P 40S14 D 40S14 D/P	2998	F1CE3481LC		
40C14 G	2998	F1CE0441A		
40C15	2998	F1CE0481FA		

6	Daily Cab. (IV)	40C17	2998	F1CE0481HA
				F1CE3481CA
				F1CE3481CB
		40C18	2998	F1CE0481HA
		45C14 45C14 /P	2998	F1CE3481LC
		45C15	2998	F1CE0481FA
		45C17	2998	F1CE0481HA
				F1CE3481CA
				F1CE3481CB
		45C18	2998	F1CE0481HA
		50C14 50C14 /P	2998	F1CE3481LC
		50C14 G	2998	F1CE0441A
		50C15	2998	F1CE0481FA
		50C17	2998	F1CE0481HA
				F1CE3481CA
				F1CE3481CB
		50C18	2998	F1CE0481HA
		55C16	2998	F1CE0481A
		55S17 W	2998	F1CE0481HA
				F1CE3481CA
		55S18 W	2998	F1CE0481HC
		60C14-C14 /P	2998	F1CE3481LC
		60C15	2998	F1CE0481FA
		60C17	2998	F1CE0481HA
				F1CE3481CA
				F1CE3481CB
		60C18	2998	F1CE0481HC
		65C14 65C14 /P	2998	F1CE3481LC
65C14 G	2998	F1CE0441A		
65C15	2998	F1CE0481FA		
65C17	2998	F1CE0481HA		
		F1CE3481CA		
		F1CE3481CB		
65C18	2998	F1CE0481HC		
70C14 70C14 /P	2998	F1CE3481LC		
70C15	2998	F1CE0481FA		
70C17 70C17 /P	2998	F1CE0481HA		

**MOTORI PER MODELLO**

**ENGINE PER MODEL**

IVECO				
model	version	c.c.	engine	
7	Daily Cab. (MY2014)	30S15	2998	F1AFL411C
		33S15 35S15		F1CFL411J
		33S11 35S11 35C11 30S11	2287	F1AE3481A
				F1AFL411A
		33S13 35S13 35C13	2287	F1AE3481B
				F1AFL411B
		33S15 35S15 35C15	2287	F1AE3481C
				F1AFL411C
		35S15	2998	F1CFL411F
		35S15 35C15 40C15 50C15 65C15 70C15	2998	F1CE3481J
				F1CFL411E
				F1CFL411J
		35S17 HW 35S17 HWD 55S17 HW 55S17 HWD 4x4	2998	F1CFL411F
				F1CFL411H
		35S17 35C17 40C17 50C17 65C17 70C17	2998	F1CE3481K
				F1CFL411F
				F1CFL411H
		35S21 35C21 40C21 50C21 65C21 70C21	2998	F1CE3481D
				F1CFL411G
		Natural Power 35S14 35C14 40C14 50C14 65C14. 7	2998	F1CFA401A
8	Daily Cab. (V)	26L11 26L11D 35C11D 35S11 40C11	2287	F1AE3481A
		29L11		2287
		29L13	2287	F1AE3481B
		29L13 29L13D 35C13D 40C13	2287	F1AE3481B
		29L15		2287
		35C15 35C15D 35S15 40C15 45C15 50C15 70C15	2998	F1CE3481J
				F1CE3481L
		35C17 35C17D 35S17 40C17 45C17 50C17 70C17	2998	F1CE3481C
				F1CE3481K
		35C21 35S21 40C21 45C21 50C21 70C21	2998	F1CE3481D
		35S15		2998
				F1CE3481L

9	Daily Furg. (III)	29L10 V	2287	F1AE0481A		
		29L12 V	2287	F1AE0481B		
		29L14	2287	F1AE0481M		
		35 C 10 V	2287	F1AE0481A		
		35 C 12 V	2287	F1AE0481B		
		35 C 14	2998	F1CE0481A		
		35 C/S 14	2287	F1AE0481M		
		35 C/S 17	2998	F1CE0481B		
		40 C 10	2286	F1AE0481A		
		40 C 12	2286	F1AE0481B		
		40 C 14	2287	F1AE0481M		
			2998	F1CE0481A		
		40 C/S 17	2998	F1CE0481B		
		45 C 14	2998	F1CE0481A		
		50 C 14	2998	F1CE0481A		
		50 C 17	2998	F1CE0481B		
		65 C 14	2998	F1CE0481A		
		65 C 17	2998	F1CE0481B		
		10	Daily Furg. (IV)	29L10 V	2287	F1AE0481FA
				29L12 V	2287	F1AE0481GA
29L14 C	2287			F1AE0481HA		
3.0 d	2998			F1CE3481LC		
35C10 V	2287			F1AE0481FA		
35C11 V 35S11 V 35C11 SV	2287			F1AE0481FA		
35C12V	2287			F1AE0481GA		
35C13 V 35S13 V 35C13 SV	2287			F1AE0481GA		
				F1AE0481V		
35C14 35S14	2998			F1CE3481LC		
35C14 G 35S14 G	2998			F1CE0441A		
35C15 V	2998			F1CE0481FA		
35C17 V 35S17 V 35S17 SV	2998			F1CE0481HA		
		F1CE3481CA				
		F1CE3481CB				
35C18 V	2998	F1CE0481HA				
35S14 C	2287	F1AE0481HA				
35S15	2998	F1CE0481FA				
		F1CE0481L				
35S18W	2998	F1CE0481HC				
40C10 V	2287	F1AE0481FA				



**MOTORI PER MODELLO**

**ENGINE PER MODEL**



IVECO											
model	version	c.c.	engine								
10	Daily Furg. (IV)	40C11 V 40C11 SV	F1AE0481FA	2287	11	Daily Furg. (MY2014)	30S15 33S15 35S15	2998	F1AFL411C		
			F1AE0481UA				F1CFL411J				
			F1AE0481UB				F1AE3481A				
		40C12 V	2287	F1AE0481GA			33S11 35S11 35C11 30S11	2287	F1AFL411A		
				F1AE0481GA			F1AFL411B				
		40C13 V 40C13 SV	2287	F1AE0481GA			33S13 35S13 35C13	2287	F1AE3481C		
				F1AE0481V			F1AFL411C				
				F1AE0481VA			2998	F1CFL411F			
				F1AE0481VB				F1CE3481J			
		40C14	2998	F1CE3481LC			35S15 35C15 40C15 50C15 65C15 70C15	2998	F1CFL411E		
		40C14 G	2998	F1CE0441A					F1CFL411J		
		40C15 V	2998	F1CE0481FA					F1CE3481K		
		40C17 V 40C17 SV	2998	F1CE0481HA					35S17 35C17 40C17 50C17 65C17 70C17	2998	F1CFL411F
				F1CE3481CA			F1CFL411H				
				F1CE3481CB			F1CE3481D				
		40C18 V	2998	F1CE0481HA			35S21 35C21 40C21 50C21 65C21 70C21	2998	F1CFL411G		
		45C15 V	2998	F1CE0481FA					Natural Power 35S14 35C14 40C14 50C14 65C14. 7	2998	F1CE3481A
		45C17 V 45C17 V/P	2998	F1CE0481HA							F1CE3481C
		45C18 V	2998	F1CE0481HA							F1CE3481B
		50C14	2998	F1CE3481LC			29L11 35C11 35S11 40C11	2287	F1AE3481A		
		50C14 G	2998	F1CE0441A					29L15	2287	F1AE3481C
		50C15 V	2998	F1CE0481FA							29L15 35C15L 40C15L 50C15L
		50C17 V 50C17 SV	2998	F1CE0481HA			29L3 35C13 35S13 40C13 40S13 V	2287	F1AE3481B		
				F1CE3481CA					35C15. 40C15	2998	
				F1CE3481CB							35C17S
		50C18 V	2998	F1CE0481HA			35C21 35S21 40C21 45C21 50C21	2998	F1CE3481D		
		55C16	2998	F1CE0481A					35S11	2287	F1AE3481A
		55C17	2998	F1CE0481HA			35S14	2998			F1CE3481L
		60C15 V	2998	F1CE0481FA					35S15	2287	F1AE3481C
		60C17 V	2998	F1CE0481HA			35C21 35S21 40C21 45C21 50C21	2998			F1CE3481D
				F1CE3481CA					35S11	2287	F1AE3481A
				F1CE3481CB							35S14
		60C18	2998	F1CE0481HC			35S15	2287	F1AE3481C		
		65C14	2998	F1CE3481LC					35S11	2287	F1AE3481A
		65C15 V	2998	F1CE0481FA			35S14	2998			F1CE3481L
		65C17 V	2998	F1CE0481HA					35C21 35S21 40C21 45C21 50C21	2998	F1CE3481D
				F1CE3481CA			35S11	2287			F1AE3481A
				F1CE3481CB							35S14
		65C18 V	2998	F1CE0481HC			35S15	2287	F1AE3481C		
		70C14 V 70C14 V/P	2998	F1CE3481LC					35S15	2287	F1AE3481C
		70C17 V 70C17 V/P	2998	F1CE0481HA							

**MOTORI PER MODELLO**

**ENGINE PER MODEL**

<b>IVECO</b>				
				
model	version	c.c.	engine	
13	Daily Ribaltabile (IV)	35C10 K	2287	F1AE0481FA
		35C11	2287	F1AE0481FA
				F1AE0481UA
				F1AE0481UB
		35C12 K	2287	F1AE0481GA
		35C13	2287	F1AE0481GA
				F1AE0481V
				F1AE0481VA
		35C15 K	2998	F1AE0481VB
				F1CE3481LC
				F1CE0481FA
		35C17	2998	F1CE0481HA
				F1CE3481CA
				F1CE3481CB
		35C18 K	2998	F1CE0481HA
		35S14 K 35S14 DK	2287	F1AE0481HA
		35S18W	2998	F1CE0481HC
		40C14 K 40C14 DK 40S14 K 40S14 DK	2998	F1CE3481LC
		40C17	2998	F1CE0481HA
				F1CE3481CA
				F1CE3481CB
		50C14 K 50C14 DK	2998	F1CE3481LC
		50C15 K	2998	F1CE0481FA
		50C17	2998	F1CE0481HA
				F1CE3481CA
				F1CE3481CB
		50C18 K	2998	F1CE0481HA
		60C14 K C14 DK	2998	F1CE3481LC
		60C15 K	2998	F1CE0481FA
		60C17	2998	F1CE0481HA
F1CE3481CA				
F1CE3481CB				
60C18 V C18 V/P	2998	F1CE0481HC		
65C14 K 65C14 DK	2998	F1CE3481LC		
65C17	2998	F1CE0481HA		
		F1CE3481CA		
		F1CE3481CB		
70C14 K 70C14 DK 70C14 KK	2998	F1CE3481LC		
70C17 K 70C17 DK 70C17 KK	2998	F1CE0481HA		

14	Daily Ribaltabile (V)	35C11K 35S11DKP	2287	F1AE3481A
		35C13K 35C13DKP	2287	F1AE3481B
		35C15K 35S15DKP 50C15K.C15K 65C15DK 70C15K	2998	F1CE3481L
		35C17K 35S17DKP 50C17K 65C17DK 70C17K	2998	F1CE3481C
				F1CE3481K
		35S21DKP	2998	F1CE3481D
15	Daily Citys Bus	50C15	2998	F1CFL411E
		50C17	2998	F1CFL411F
16	Daily Line Bus	40C15 50C15	2998	F1CFL411E
		40C17 50C17	2998	F1CFL411F
		50C14 Natural Power	2998	F1CFA401A
17	Daily Tourys Bus	50C17 65C17	2998	F1CFL411F
18	Massif (25S1)	3.0 HPI	2998	F1CE0481FA
		3.0 HPT	2998	F1CE0481HA
19	Massif Pick up (25S1)	3.0 HPI	2998	F1CE0481FA
		3.0 HPT	2998	F1CE0481HA
20	Massif Wagon (25S1)	3.0 HPI	2998	F1CE0481FA
		3.0 HPT	2998	F1CE0481HA
21	Power Daily Bus	3.0 d	2998	F1CE0481P

<b>KIA</b>				
				
model	version	c.c.	engine	
1	Carens (RP)	1.7 CRDi	1685	D4FD
			D4FDL	
2	Carens Station wagon (UN)	1.6 CRDi	1582	D4FB
3	Cee' d (ED)	1.6 CRDi	1582	D4FB
			D4FBL	
4	Cee' d (JD)	1.4 CRDi	1396	D4FC
			1.6 CRDi	1582
5	Cee' d Station wagon (ED)	1.6 CRDi	1582	D4FB
			D4FBL	
6	Cee' d Station wagon (JD)	1.4 CRDi	1396	D4FC
			1.6 CRDi	1582
7	Cerato (LD)	1.5 CRDi	1493	D4FA
			1.6 CRDi	1582
8	Cerato Sedan (LD)	1.5 CRDi	1493	D4FA
			1.6 CRDi	1582
9	Optima (MY2012)	1.7 CRDi	1685	D4FD
			D4FDL	

**MOTORI PER MODELLO**

**ENGINE PER MODEL**

<b>KIA</b>				
	model	version	c.c.	engine
10	Picanto (BA)	1.1 CRDi	1120	D3FA
11	Pro Cee' d (ED)	1.6 CRDi	1582	D4FB
				D4FBL
12	Pro Cee' d (JD)	1.4 CRDi	1396	D4FC
		1.6 CRDi	1582	D4FB
13	Rio (JB)	1.5 CRDi	1493	D4FA
14	Rio (UB)	1.1 CRDi	1120	D3FA
		1.4 CRDi	1396	D4FC
15	Rio Sedan (JB)	1.5 CRDi	1493	D4FA
16	Sorento (I JC)	2.5 CRDi	2497	D4CB
17	Soul (AM)	1.6 CRDi	1582	D4FB
				D4FB5
18	Soul (PS)	1.6 CRDi	1582	D4FB
19	Sportage (SL)	1.7 CRDi	1685	D4FDL
20	Venga (YN)	1.4 CRDi	1396	D4FC

<b>LADA</b>				
	model	version	c.c.	engine
1	1200-1500 Station wagon	1.30	1294	
		1500	1452	BA32103
2	1200-1600	1500	1458	BA32103
		1500 N/S	1452	BA32103
		1600	1568	BA32103

<b>LANCIA</b>				
	model	version	c.c.	engine
1	Musa (350A)	1.3 Multijet	1248	188A9000
				199A3000
				199B1000
2	Phedra (179)	2.0 D Multijet	1997	RHRDW10BTED4
				RHKDW10UTED4
		2.0 JTD	1997	RHMDW10ATED4
				RHT
				RHWDW10ATED4
2.2 JTD	2179	4HWDW12ATED4		
3	Ypsilon (843)	1.3 Multijet	1248	188A9000
				199A2000
				199A3000
				199A9000
4	Ypsilon (846)	0.9	875	312A2000
				312A2000
		0.9 Twin Air	875	312A5000
		0.9 Twinair CNG	875	312A2000
		1.3 D Multijet	1248	312B5000
1.3 Multijet	1248	199B1000		
		312B1000		

<b>MAZDA</b>				
	model	version	c.c.	engine
1	3 (BK)	1.6 DI Turbo	1560	Y601
2	3 (BL)	1.6 MZR-CD	1560	Y601
				Y642
3	3 Sedan (BK12)	1.6 DI Turbo	1560	Y601
4	3 Sedan (BL)	1.6 MZ-CD	1560	Y642

<b>MERCEDES</b>				
	model	version	c.c.	engine
1	200 (W124)	200 E	1998	M111940
		220 E	2199	M111960
2	200 Coupé (C124)	220 CE	2199	M111960
3	200 Station wagon (S124)	200 TE	1998	M111940
		220 TE	2199	M111960
4	CLA Coupé (C117)	200 CDI	1796	OM651901
		200 CDI 4-matic	2143	OM651930
		220 CDI	2143	OM651930
		220 CDI 4-matic	2143	OM651930
5	CLA Shooting Brake (X117)	200 CDI	2143	OM651930
		200 CDI 4-matic	2143	OM651930
		220 CDI	2143	OM651930
		220 CDI 4Matic	2143	OM651930
		CLA 220 CDI CLA 200 d 4-matic	2143	OM651930
		CLA 220 CDI CLA 220 d	2143	OM651930
6	Classe A (W168)	A 140	1397	M166940
		A 160	1598	M166960
		A 190	1898	M166990
		A 210	2084	M166995
7	Classe A (W169)	A 160 CDI	1991	OM640942
		A 180 CDI	1991	OM640940
		A 200 CDI	1991	OM640941
8	Classe A (W176)	200 CDI 4-matic	2143	OM651930
		220 CDI 4-matic	2143	OM651930
		A 180 CDI	1796	OM651901
		A 200 CDI	1796	OM651901
		A 220 CDI	2143	OM651930
A 220 d	2143	OM651930		
		A 220 d 4-matic	2143	OM651930
9	Classe B (W245)	B 180 CDI	1991	OM640940
		B 200 CDI	1991	OM640941
10	Classe B (W246)	B 180 CDI	1796	OM651901
		B 200 CDI	1796	OM651901
		B 220 CDI	2143	OM651930

**MOTORI PER MODELLO**

**ENGINE PER MODEL**



**MERCEDES**

model		version	c.c.	engine
11	Classe C (W202)	C 180	1799	M111920
			M111921	
		C 200	1998	M111941
			M111945	
		C 200 Kompressor	1998	M111944
		C 220	2199	M111961
		C 230	2295	M111974
		C 230 Kompressor	2295	M111975
12	Classe C (W203)	C 180	1998	M111951
			C 180 Kompressor	1796
		C 200 CDI	2148	OM611962
			OM646962	
		C 200 CGI Kompressor	1796	M271942
		C 200 Kompressor	1796	M271940
			1998	M111955
		C 220 CDI	2148	OM611962
			OM646963	
		C 230 Kompressor	1796	M271948
C 270 CDI	2685	OM612962		
C 30 CDI AMG	2950	OM612990		
13	Classe C (W204)	C 180 CDI	2143	OM651913
			C 180 CGI	1796
		C 180 Kompressor	1597	M271910
			1796	M271952
		C 200	1796	M271820
			2143	OM651913
		C 200 CDI	2148	OM646811
			OM646812	
		C 200 CGI	1796	M271820
			M271860	
		C 200 Kompressor	1796	M271950
			2143	OM651911
		C 220 CDI	2148	OM646811
			2143	OM651912
		C 250 CDI	2143	OM651911
		C 250 CDI 4-matic	2143	OM651912
		C 250 CGI	1796	M271860
		14	Classe C (W205)	220 BlueTEC
C 200 d	2143			OM651921
C 220 BlueTEC	2143			OM651921
C 220 d 4-matic	2143			OM651921
C 250 BlueTEC	2143			OM651921
C 250 BlueTEC 4-matic	2143			OM651921
C 300 BlueTEC Hybrid	2143			OM651921
15	Classe C Cabriolet (A205)	C 220 d	2143	OM651921
		C 220 d 4-matic	2143	OM651921
		C 250 d	2143	OM651921
		C 180 CGI	1796	M271820
		C 200	1796	M271820
			M271860	
16	Classe C Coupé (C204)	C 220 CDI	2143	OM651911
		C 220 CDI BlueEFF T	2143	OM651911
		C 250 CDI	2143	OM651911
		C 250 CGI	1796	M271860
		C 220 d	2143	OM651921
		C 220 d 4-matic	2143	OM651921
17	Classe C Coupé (C205)	C 250 d	2143	OM651921
		C 250 d 4-matic	2143	OM651921
18	Classe C Sportcoupé (C203)	C 160 Kompressor	1796	M271921
		C 180	1998	M111951
		C 180 Kompressor	1796	M271946
		C 200 CDI	2148	OM646962
		C 200 CGI Kompressor	1796	M271942
		C 200 Kompressor	1796	M271940
			1998	M111955
		C 220	1796	M271940
		C 220 CDI	2148	OM611962
				OM646963
		C 230 Kompressor	1796	M271948
			2295	M111981
C 30 CDI AMG	2950	OM612990		
19	Classe C Station wagon (S202)	C 180 T	1799	M111920
			1998	M111921
				M111952
		C 200 T	1998	M111941
			M111945	
		C 200 T Kompressor	1998	M111944
			M111956	
		C 230 T	2295	M111974
		C 230 T Kompressor	2295	M111975
		20	Classe C Station wagon (S203)	C 180
C 180 Kompressor	1796			M271946
C 200 CDI	2148			OM611962
	OM646962			
C 200 CGI Kompressor	1796			M271942
C 200 Kompressor	1796			M271940
	1998			M111955
C 220 CDI	2148			OM611962
	2149			OM646963
C 230 Kompressor	1796			M271948
C 270 CDI	2685	OM612962		
C 30 CDI AMG	2950	OM612990		

**MOTORI PER MODELLO**

**ENGINE PER MODEL**

**MERCEDES**



				
model	version	c.c.	engine	
21	Classe C Station wagon (S204)	C 180 CDI	2143	OM651913
		C 180 CGI	1796	M271820
		C 180 Kompressor	1597	M271910
			1796	M271952
		C 200 CDI	2143	OM651913
			2148	OM646811
		C 200 CGI	1796	M271820
				M271860
		C 200 Kompressor	1796	M271950
		C 220 CDI	2143	OM651911
			2148	OM646811
		C 220 CDI 4-matic	2143	OM651912
		C 250 CDI 4-matic	2143	OM651912
		C 250 CDI BlueEFFICIENCY	2143	OM651911
C 250 CGI	1796	M271860		
22	Classe C Station wagon (S205)	C 200 BlueTEC	1598	OM651921
		C 220 BlueTEC	2143	OM651921
		C 220 d 4-matic	2143	OM651921
		C 250 BlueTEC	2143	OM651921
		C 250 BlueTEC 4-matic	2143	OM651921
		C 300 BlueTEC Hybrid	2143	OM651921
23	Classe CLC Sportcoupé (C204)	CLC 160	1597	M271911
		CLC 180 Kompressor	1796	M271946
		CLC 200 CDI	2148	OM646962
		CLC 200 Kompressor	1796	M271955
				M271957
CLC 220 CDI	2148	OM646963		
24	Classe E (W124)	200	1998	M111940
		220	2199	M111960
25	Classe E (W210)	E 200	1998	M111942
		E 200 CDI	2148	OM611961
			2151	OM611961
		E 200 Kompressor	1998	M111947
				M111957
		E 220 CDI	2148	OM611961
			2151	OM611961
		E 230	2295	M111970
		E 270 CDI	2685	OM612961
		E 320 CDI	3226	OM613961

26	Classe E (W211)	E 200 CDI	2148	OM646820
				OM646821
				OM646951
		E 200 CGI	1796	M271946
		E 200 Kompressor	1796	M271941
				M271956
		E 220 CDI	2148	OM646821
				OM646961
		E 250 CDI	2143	OM651924
		E 270 CDI	2685	OM647961
		E 280 CDI	3222	OM648961
		E 320 CDI	3222	OM648961
		E200 NGT	1796	M271941
				M271956
27	Classe E (W212)	220 BlueTEC-T	2143	OM651924
		E 200 CDI	2143	OM651925
		E 200 CGI	1796	M271820
				M271860
		E 200 NGT	1796	M271958
		E 220 BlueTEC	2143	OM651924
		E 220 CDI	2143	OM651924
		E 250 CDI	2143	OM651924
		E 250 CDI 4-matic	2143	651911
				OM651924
		E 250 CGI	1796	M271860
E 300 CDI Hybrid	2143	OM651924		
28	Classe E Cabrio (A124)	E 200	1998	M111940
		E 220	2199	M111960
29	Classe E Cabrio (A207)	E 200 CGI	1796	M271820
				M271860
		E 220 CDI	2143	OM651911
		E 250 CDI	2143	OM651911
30	Classe E Coupé (C124)	E 200	1998	M111940
		E 220	2199	M111960
31	Classe E Coupé (C207)	E 200 CGI	1796	M271820
				M271860
		E 220 CDI	2143	OM651911
		E 250 CDI	2143	OM651911
		E 250 CGI	1796	M271860
32	Classe E Station wagon (S124)	E 200 T	1998	M111940
		E 220 T	2199	M111960

**MOTORI PER MODELLO**

**ENGINE PER MODEL**

**MERCEDES**

				
model	version	c.c.	engine	
33	Classe E Station wagon (S210)	E 200 T	1998	M111942
		E 200 T Kompressor	1998	M111947
				M111957
		E 220 T CDI	2148	OM611961
			2151	OM611961
		E 230 T	2295	M111970
		E 270 T CDI	2685	OM612961
E 320 T CDI	3226	OM613961		
34	Classe E Station wagon (S211)	E 200 CDI	2148	OM646821
		E 200 Kompressor	1796	M271956
			1796	M271941
		E 220 CDI	2148	OM646961
		E 220 T CDI	2148	OM646821
				OM646961
		E 270 T CDI	2685	OM647961
		E 280 T CDI	3222	OM648961
E 320 T CDI	3222	OM648961		
35	Classe E Station wagon (S212)	E 200 CDI	2143	OM651925
		E 200 CGI	1796	M271820
			M271860	
		E 220 BlueTEC T	2143	OM651924
		E 220 CDI	2143	OM651924
		E 250 CDI	2143	OM651924
		E 250 CDI 4-matic	2143	651911
				OM651912
E 250 CGI	1796	M271860		
E 300 CDI Hybrid	2143	OM651924		
36	Classe G (W461)	G 270 CDI	2685	OM612966
37	Classe G (W463)	G 270 CDI	2685	OM612965
38	Classe GLK (X204)	200 CDI	2143	OM651913
			OM651916	
		220 CDI	2143	OM651916
				OM651912
250 CDI 4-matic	2143	OM651912		
		OM651912		
39	Classe M (W163)	ML 230	2295	M111977
		ML 270 CDI	2685	OM612963
40	Classe M (W166)	ML 250 CDI BlueTec 4-matic	2143	OM651960
41	Classe S (W220)	S 320 CDI	3222	OM613960
			OM648960	
42	Classe S (W221)	S 250 CDI BlueEFFICIENCY	2143	OM651961
43	Classe S (W222)	S 300 BlueTEC Hybrid	2143	OM651921



44	Classe V (W447)	200 CDI	2143	OM651950
		220 CDI	2143	OM651950
		250 BlueTEC	2143	OM651950
		250 CDI BlueTEC	2143	OM651950
		V 200 CDI V 200 d 4-matic	2143	OM651950
				OM651950
45	Classe V Bus (638)	V 200	1998	M111948
			M111950	
		V 200 CDI	2151	OM611980
			2151	OM611980
		V 230	2295	M111978
			M111980	
46	CLK Cabrio (A208)	200	1998	M111941
			M111945	
		200 Kompressor	1998	M111944
				M111956
		230 Kompressor	2295	M111973
				M111975
M111982				
47	CLK Cabrio (A209)	200 CGI	1796	M271942
		200 Kompressor	1796	M271940
			M271955	
48	CLK Coupé (C208)	200	1998	M111945
			M111944	
		200 Kompressor	1998	M111956
				M111973
		230 Kompressor	2295	M111975
				M111982
49	CLK Coupé (C209)	200 CGI	1796	M271942
			M271940	
		200 Kompressor	1796	M271955
				M271955
		220 CDI	2148	OM646963
				OM646966
270 CDI	2685	OM612962		
		OM612967		
50	CLS (C218)	220 BlueTEC	2143	OM651924
		250 BlueTEC 4-matic	2143	OM651924
		250 CDI	2143	OM651924
51	CLS Shooting Brake (X218)	220 BlueTEC	2143	OM651924
		250 BlueTEC 4-matic	2143	OM651924
		250 CDI	2143	OM651924



**MOTORI PER MODELLO**

**ENGINE PER MODEL**

**MERCEDES**



				
model	version	c.c.	engine	
52	GLA (X156)	GLA 200 CDI	2143	OM651930
		GLA 200 CDI 4-matic	2143	OM651930
		GLA 220 CDI	2143	OM651930
		GLA 220 CDI 4-matic	2143	OM651930
		GLA 220 d	2143	OM651930
		GLA 220 d 4-matic	2143	OM651930
53	GLC (X253)	220 d 4MATIC	2143	OM651921
		220 d 4-matic	2143	OM651921
		250 d 4-matic	2143	OM651921
54	GLC Coupé (C253)	220 d 4-matic	2143	OM651921
		250 d 4-matic	2143	OM651921
55	GLE (W166)	250 d	2143	OM651960
		250 d 4-matic	2143	OM651960
56	SLC (R172)	250 d	2143	OM651980
57	SLK (R172)	200 CGI	1796	M271860
				M271861
		250 CDI	2143	OM651980
				250 CGI
58	SLK Cabrio (R170)	200	1998	M111946
				M111943
		200 Kompressor	1998	M111958
				M111973
		230 Kompressor	2295	M111983
				M111983
59	SLK Cabrio (R171)	200 Kompressor	1795	M271944
			1796	M271954
60	Sprinter Bus (2-T 901-902)	208 CDI	2148	OM611987
		211 CDI	2148	OM611981
		213 CDI	2148	OM611981
		214	2295	M111979
		214 NGT	2295	M111984
		216 CDI	2685	OM612981
		414	2295	M111984

61	Sprinter Bus (3.5-T 906)	310 CDI	2143	OM651955		
				OM651956		
		311 CDI	2143	OM651955		
			2148	OM646985		
		311 CDI 4x4	2148	OM646985		
		313 CDI	2143	OM651955		
				OM651956		
		313 CDI 4x4	2143	OM651955		
				OM651956		
		314 CDI	2143	OM651955		
		314 CDI 4x4	2143	OM651955		
		315 CDI	2148	OM646986		
				OM646989		
				OM646990		
315 CDI 4x4	2148	OM646986				
		OM646989				
		OM646990				
316	1796	M271951				
316 CDI	2143	OM651955				
		OM651957				
316 CDI 4x4	2143	OM651955				
		OM651957				
316 LGT	1796	M271951				
316 NGT	1796	M271951				
62	Sprinter Bus (3-T 903)	308 CDI	2148	OM611987		
		311 CDI	2148	OM611981		
		311 CDI 4x4	2148	OM611981		
		313 CDI	2148	OM611981		
		313 CDI 4x4	2148	OM611981		
		314	2295	M111984		
		314 4x4	2295	M111984		
		314 METANO	2295	M111984		
		316 CDI	2685	OM612981		
		316 CDI 4x4	2685	OM612981		
		414	2295	M111984		
		63	Sprinter Bus (3-T 906)	210 CDI	2143	OM651955
				211 CDI	2143	OM651955
					2148	OM646985
213 CDI	2143			OM651955		
				OM651956		
214 CDI	2143			OM651955		
				OM646986		
215 CDI	2148			OM646989		
				OM646990		
216	1796			M271951		
216 CDI	2143			OM651955		
				OM651957		
64	Sprinter Bus (4.6-T)			415 CDI	2143	OM651957

**MOTORI PER MODELLO**

**ENGINE PER MODEL**

**MERCEDES**

						
model	version	c.c.	engine			
65	Sprinter Bus (4-T 904)	408 CDI	2148	OM611987		
		411 CDI	2148	OM611981		
		413 CDI	2148	OM611981		
		414	2295	M111979		
				M111984		
		416 CDI	2685	OM612981		
66	Sprinter Bus (5-T)	513 CDI	2143	OM651956		
		515 CDI	2143	OM651957		
		516 CDI	2143	OM651957		
67	Sprinter Cab. (2-T 901-902)	208 CDI	2148	OM611987		
		211 CDI	2148	OM611981		
		213 CDI	2148	OM611981		
		214	2295	M111979		
		214 NGT	2295	M111984		
		216 CDI	2685	OM612981		
		414	2295	M111984		
68	Sprinter Cab. (3.5-T 906)	309 CDI	2148	OM646984		
		310 CDI	2143	OM651955		
		311 CDI	2143	OM651955		
				OM646985		
		311 CDI 4x4	2148	OM646985		
		313 CDI	2143	OM651955		
				OM651956		
		313 CDI 4x4	2143	OM651955		
				OM651956		
		314 CDI	2143	OM651955		
		314 CDI 4x4	2143	OM651955		
		315 CDI	2148	OM646986		
				OM646989		
				OM646990		
		315 CDI 4x4	2148	OM646986		
				OM646989		
				OM646990		
		316	1796	M271951		
		316 CDI	2143	OM651955		
				OM651957		
		316 CDI 4x4	2143	OM651955		
				OM651957		
		316 LGT	1796	M271951		
		316 METANO	1796	M271951		
316 NGT	1796	M271951				
69	Sprinter Cab. (3-T 903)	308 CDI	2148	OM611987		
		311 CDI	2148	OM611981		
		311 CDI 4x4	2148	OM611981		
		313 CDI	2148	OM611981		
		313 CDI 4x4	2148	OM611981		
		314	2295	M111984		
		314 4x4	2295	M111984		
		314 NGT	2295	M111984		
		316 CDI	2685	OM612981		
		316 CDI 4x4	2685	OM612981		
		414	2295	M111984		
		70	Sprinter Cab. (3-T 906)	209 CDI	2148	OM646984
210 CDI	2143			OM651955		
				OM651956		
211 CDI	2143			OM651955		
				OM646985		
213 CDI	2148			OM651956		
				OM646986		
214 CDI	2143			OM646989		
				OM651955		
215 CDI	2148			OM646986		
				OM646989		
216	1796			M271951		
		OM651957				
71	Sprinter Cab. (4.6-T 906)	411 CDI	2148	OM646985		
		413 CDI	2148	OM651956		
				OM646986		
		415 CDI	2148	OM646986		
				OM646989		
		416 CDI	2143	OM651957		
				OM646990		
		72	Sprinter Cab. (4-T 904)	408 CDI	2148	OM611987
				411 CDI	2148	OM611981
				411 CDI 4x4	2148	OM611981
				413 CDI	2148	OM611981
				413 CDI 4x4	2148	OM611981
414	2295			M111979		
				M111984		
414 4x4	2295			M111979		
				M111984		
416 CDI	2685			OM612981		
416 CDI 4x4	2685			OM612981		
73	Sprinter Cab. (5-T 905)			414	2295	M111984
		616 CDI	2685	OM612981		

**MOTORI PER MODELLO**

**ENGINE PER MODEL**



<b>MERCEDES</b>				
model	version	c.c.	engine	
74	Sprinter Cab. (5-T 906)	509 CDI	2148	OM646984
		510 CDI	2143	OM651955
		511 CDI	2143	OM651955
			2148	OM646985
		511 CDI 4x4	2148	OM646985
		513 CDI	2143	OM651956
			2148	OM646986
		513 CDI 4x4	2143	OM651955
				OM651956
		514 CDI	2143	OM651955
		514 CDI 4x4	2143	OM651955
		515 CDI	2148	OM646986
				OM646989
				OM646990
		515 CDI 4x4	2148	OM646963
				OM646966
				OM646986
				OM646989
				OM646990
		516	1796	M271951
516 CDI	2143	OM651957		
516 CDI 4x4	2143	OM651957		
516 NGT	1796	M271951		
75	Sprinter Furg. (2-T 901-902)	208 CDI	2148	OM611987
		211 CDI	2148	OM611981
		213 CDI	2148	OM611981
		214	2295	M111979
				M111984
		214 NGT	2295	M111984
		216 CDI	2685	OM612981
		414	2295	M111984

76	Sprinter Furg. (3.5-T 906)	309 CDI	2148	OM646984
		310 CDI	2143	OM651955
		311 CDI	2143	OM651955
			2148	OM646985
		311 CDI 4x4	2148	OM646985
		313 CDI	2143	OM651955
				OM651956
				OM646986
		313 CDI 4x4	2143	OM646986
				OM651955
				OM651956
		314 CDI	2143	OM651955
		314 CDI 4x4	2143	OM651955
		315 CDI	2148	OM646986
				OM646989
				OM646990
		315 CDI 4x4	2148	OM646986
				OM646989
				OM646990
		316	1796	M271951
		316 CDI	2143	OM651955
				OM651957
		316 CDI 4x4	2143	OM651955
				OM651957
		316 LGT	1796	M271951
		316 METANO	1796	M271951
		316 NGT	1796	M271951
77	Sprinter Furg. (3-T 903)	308 CDI	2148	OM611987
		311 CDI	2148	OM611981
		311 CDI 4x4	2148	OM611981
		313 CDI	2148	OM611981
		313 CDI 4x4	2148	OM611981
		314	2295	M111979
				M111984
		314 4x4	2295	M111984
		314 NGT	2295	M111984
		316 CDI	2685	OM612981
		316 CDI 4x4	2685	OM612981
414	2295	M111984		

**MOTORI PER MODELLO**

**ENGINE PER MODEL**



**MERCEDES**

model 		version	c.c.	engine 
<b>78</b>	Sprinter Furg. (3-T 906)	209 CDI	2148	OM646984
		210 CDI	2143	OM651955
		211 CDI	2143	OM651955
			2148	OM646985
		213 CDI	2143	OM651955
				OM651956
			2148	OM646986
			OM646989	
		214 CDI	2143	OM651955
		215 CDI	2148	OM646986
				OM646989
				OM646990
		216	1796	M271951
		216 CDI	2143	OM651955
				OM651957
<b>79</b>	Sprinter Furg. (4.6-T 906)	411 CDI	2148	OM646985
		413 CDI	2143	OM651956
			2148	OM646986
		415 CDI	2148	OM646963
				OM646966
				OM646986
			OM646989	
	OM646990			
416 CDI	2143	OM651957		
<b>80</b>	Sprinter Furg. (4-T 904)	408 CDI	2148	OM611987
		411 CDI	2148	OM611981
		411 CDI 4x4	2148	OM611981
		413 CDI	2148	OM611981
		413 CDI 4x4	2148	OM611981
		414	2295	M111979
				M111984
		414 4x4	2295	M111979
				M111984
		416 CDI	2685	OM612981
		416 CDI 4x4	2685	OM612981
<b>81</b>	Sprinter Furg. (5-T 906)	509 CDI	2148	OM646984
		510 CDI	2143	OM651955
		511 CDI	2143	OM651955
			2148	OM646985
		511 CDI 4x4	2148	OM646985
		513 CDI	2143	OM651955
				OM651956
			2148	OM651957
			OM646986	
		513 CDI 4x4	2143	OM651956
		514 CDI	2143	OM651955
		514 CDI 4x4	2143	OM651955
		515 CDI	2148	OM646986
				OM646989
			OM646990	
		515 CDI 4x4	2148	OM646963
				OM646966
				OM646986
				OM646989
	OM646990			
516 CDI	2143	OM651957		
516 CDI 4x4	2143	OM651957		
<b>82</b>	Sprinter Ribaltabile	414	2295	M111984
		616 CDI	2685	OM612981
<b>83</b>	Vaneo Multispace (W414)	1.4	1397	M166940
		1.6	1598	M166961
		1.9	1898	M166991
<b>84</b>	Viano Multispace (W639)	2.0 CDI	2148	OM646980
				OM646982
		2.0 CDI 4-matic	2148	OM646980
				OM646982
		2.2 CDI	2143	OM651940
		2.2 CDI 4-matic	2143	OM651940
		CDI 2.0	2148	OM646983
		CDI 2.2	2148	OM646982
		CDI 2.2 4-matic	2148	OM646982
<b>85</b>	Vito Bus (V638)	112 CDI 2.2	2151	OM611980
		113 2.0	1998	M111948
				M111950
		114 2.3	2295	M111978
				M111980
		V 230	2295	M111980
<b>86</b>	Vito Bus (W447)	114 CDI	2143	OM651950
		114 CDI 4x4	2143	OM651950
		116 CDI	2143	OM651950
		116 CDI 4x4	2143	OM651950
		119 BlueTEC	2143	OM651950
		119 BlueTEC 4x4	2143	OM651950

**MOTORI PER MODELLO**



**ENGINE PER MODEL**

**MERCEDES**

				
model	version	c.c.	engine	
<b>87</b>	Vito Bus (W639)		OM646980	
		109 CDI 2.2	2148	OM646981
				OM646983
		109 CDI 2.2 4x4	2148	OM646981
		110 CDI 2.2	2143	OM651940
		111 CDI 2.2	2148	OM646980
				OM646982
		111 CDI 2.2 4x4	2148	OM646980
				OM646982
		113 CDI 2.2	2143	OM651940
		113 CDI 2.2 4-matic	2143	OM651940
		115 CDI 2.2	2148	OM646982
		115 CDI 2.2 4x4	2148	OM646982
		116 CDI 2.2	2143	OM651940
		116 CDI 2.2 4-matic	2143	OM651940
		<b>88</b>	Vito Furg. (V638)	112 CDI 2.2
				M111948
113 2.0	1998			M111950
114 2.3	2295			M111978
				M111980
V 230	2295			M111980
<b>89</b>	Vito Furg. (W447)	114 CDI	2143	OM651950
		114 CDI 4x4	2143	OM651950
		116 CDI	2143	OM651950
		116 CDI 4x4	2143	OM651950
		119 BlueTEC	2143	OM651950
		119 BlueTEC 4x4	2143	OM651950
<b>90</b>	Vito Mixto (W447)	114 CDI	2143	OM651950
		114 CDI 4x4	2143	OM651950
		116 CDI	2143	OM651950
		116 CDI 4x4	2143	OM651950
		119 BlueTEC	2143	OM651950
		119 BlueTEC 4x4	2143	OM651950



<b>91</b>	Vito Mixto (W639)	109 CDI	2148	OM646980
				OM646981
		109 CDI 2.2	2148	OM646983
		110 CDI 2.2	2143	OM651940
		111 CDI 2.2	2148	OM646980
				OM646982
		111 CDI 2.2 4x4	2148	OM646980
				OM646982
		113 CDI 2.2	2143	OM651940
		113 CDI 2.2 4-matic	2143	OM651940
		115 CDI 2.2	2148	OM646980
				OM646982
		115 CDI 2.2 4x4	2148	OM646982
		116 CDI 2.2	2143	OM651940
116 CDI 2.2 4-matic	2143	OM651940		
CDI 2.0	2148	OM646983		



**MINI**



				
model	version	c.c.	engine	
<b>1</b>	Mini-F54 Clubman	One D	1496	B37C15A
<b>2</b>	Mini-F55 5 porte	1.5 Cooper D	1496	B37C15A
		1.5 One D	1496	B37C15A
<b>3</b>	Mini-F56	Mini 1.5 Cooper D	1496	B37C15A
<b>4</b>	Mini-F60 Countryman	One D	1496	B37C15A
<b>5</b>	Mini-R50-R53	One D	1364	1ND
				1NDTV
<b>6</b>	Mini-R55 Clubman	Cooper D	1560	9HZDV6TED4
				W16D16
			1598	N47C16A
		1995	N47C20A	
		Cooper SD	1995	N47C20A
	One D	1598	N47C16A	
<b>7</b>	Mini-R55 Clubvan	Cooper D	1598	N47C16A
			1995	N47C20A
<b>8</b>	Mini-R56	Cooper D	1560	9HZDV6TED4
				W16D16
			1598	N47C16A
		1995	N47C20A	
		Cooper SD	1995	N47C20A
<b>9</b>	Mini-R57 Cabrio	One D	1560	9HZ
			1598	9HZDV6TED4
<b>9</b>	Mini-R57 Cabrio	Cooper D	1598	N47C16A
			1995	N47C20A
	Cooper SD	1995	N47C20A	
<b>10</b>	Mini-R58 Coupé	Cooper SD	1995	N47C20A
<b>11</b>	Mini-R59 Roadster	Cooper SD	1995	N47C20A



**MOTORI PER MODELLO**

**ENGINE PER MODEL**

<b>MINI</b>				
				
	model	version	c.c.	engine
12	Mini-R60 Countryman	Cooper D	1598	N47C16A
			1995	N47C20A
		Cooper D ALL4	1598	N47C16A
			1995	N47C20A
		Cooper SD	1995	N47C20A
		Cooper SD ALL4	1995	N47C20A
		One D	1598	N47C16A
13	Mini-R61 Paceman	Cooper D	1598	N47C16A
			1995	N47C20A
		Cooper D ALL4	1598	N47C16A
			1995	N47C20A
		Cooper SD	1995	N47C20A
		Cooper SD ALL4	1995	N47C20A

<b>NISSAN</b>						
						
	model	version	c.c.	engine		
9	Navara Pick up (D40)	2.5 dCi	2488	YD25DDTI		
10	Pathfinder (R51)	2.5 dCi	2488	YD25DDTI		
		2.5 dCi 4WD	2488	YD25DDTI		
11	Primastar Bus (X83)	dCi	1995	M9R630A6		
				M9R692F6		
				M9R780		
				M9R782		
				M9R786M7		
12	Primastar Cab.	2.0 CDTi	1995	M9R692F6		
				2.0 CDTi DPF	1995	M9R630A6
13	Primastar Furg. (X83)	dCi	1995	M9R630A6		
				M9R692F6		
				M9R780		
				M9R782		
				M9R786M7		
14	Primera Station wagon (W10)	1.6 i	1597	GA16DE		
				GA16DS		
15	Qashqai (J10-JJ10)	2.0 dCi	1995	M9R		
		2.0 dCi Allrad	1995	M9R		
16	Sunny Coupé (N14)	1.4	1392	GA14DS		
				1.4i	1392	GA14DE
				1.6i	1597	GA16DE
17	Sunny Hatchback (N14)	1.4	1392	GA14DS		
				1.4i	1392	GA14DE
				1.6i	1597	GA16DE
				1.4	1392	GA14DS
				1.4i	1392	GA14DS
18	Sunny Sedan (N14)	1.6	1597	GA14DE		
				1.4i	1392	GA14DS
				1.6	1597	GA16DE
				1.6 4WD	1597	GA16DE
				1.6 i	1597	GA16DE
				1.6 i 4WD	1597	GA16DE
19	Sunny Station wagon (Y10)	1.6	1597	GA16DS		
				1.6 i	1597	GA16DE
				1.6 i 4x4	1597	GA16DE
20	Sunny Van (Y10)	1.6 i	1597	GA16DE		
21	X-Trail (T31)	2.0 dCi	1995	M9R		
		2.0 dCi FWD	1995	M9R760		

<b>MITSUBISHI</b>				
				
	model	version	c.c.	engine
1	Montero Sport (K90)	2.8 TDi	2835	4M40T
2	Pajero (V2-V3-V4)	2.8 D 4WD	2835	4M40A
		2.8 TD	2835	4M40T
3	Pajero (V6-V7)	3.2 DI-D	3200	4M41
4	Pajero Cabrio (V60-V70)	3.2 DI-D	3200	4M41
5	Pajero Classic (V2)	3.2 DI-D	3200	4M41
6	Pajero Sport (K90)	2.8 TDi	2835	4M40T

<b>NISSAN</b>				
				
	model	version	c.c.	engine
1	100 NX (B13)	1.6	1597	GA16DS
		1.6 SR	1597	GA16DE
2	Almera Hatchback (N15)	1.4	1392	GA14DE
		1.4 S-GX-LX	1392	GA14DE
		1.6	1597	GA16DE
		1.6 SR-SLX	1597	GA16DE
3	Almera Sedan (N15)	1.4	1392	GA14DE
		1.4 GX-LX	1392	GA14DE
		1.6	1597	GA16DE
		1.6 SLX	1597	GA16DE
4	Cabstar Cab. (F23-H41-H42)	2.5 dCi	2488	YD25DDTI
5	Cabstar Cab. (F24)	2.5 dCi	2488	YD25DDTI
6	Micra (K11)	1.0 i	998	CG10DE
		1.3 i	1275	CG13DE
7	Micra (K12)	1.0	998	CG10DE
8	Navara (D40)	2.5 dCi	2488	YD25DDTI
		2.5 dCi 4WD	2488	YD25DDTI

**MOTORI PER MODELLO**

**ENGINE PER MODEL**



<b>NISSAN</b>			
model	version	c.c.	engine
<b>22</b>	X-Trail (T32)	2.0 dCi	1995 M9R
		2.0 dCi ALL MODE 4x4-i	1995 M9R



<b>OPEL</b>					
model	version	c.c.	engine		
<b>1</b>	Adam	1.2	A12XEL		
			B12XEL		
		1.4	A14XEL		
			A14XER		
			B14XEL		
			B14XER		
	1.4 GPL	B14XERLDD			
		B14XEL			
	1.4 S	B14NEH			
		B14NET			
	1.4 Turbo	B14NEHLUJ			
	<b>2</b>	Agila (H08)	1.3 CDTI	1248 Z13DTJ	
	<b>3</b>	Agila (I)	1.0	973 Z10XE	
				998 Z10XEP	
1.2			1199 Z12XE		
1.2 Twinport			1229 Z12XEP		
1.3 CDTI			1248 Z13DT		
<b>4</b>	Ampera	EV	1398 A14XFL		
<b>5</b>	Antara (L07)	2.4	A24XE		
			A24XELE9		
		2.4 FWD	2384 A24XE		
<b>6</b>	Astra (G)	1.2	X12XE		
			Z12XE		
		1.4	1364 Z14XEP		
		2.0 DI	1995 X20DTL		
			1995 Y20DTL		
		2.0 DTI	1995 Y20DTH		
		2.2	2198 Z22SE		
		2.2 DTI	2172 Y22DTR		
		<b>7</b>	Astra (H)	1.2	1199 X12XE
					1229 Z12XEP
1.3 CDTI	1248 Z13DTH				
1.4	1364 Z14XEL				
	Z14XEP				
1.4 GPL	1364 Z14XEP				
2.2	2198 Z22YH				

<b>OPEL</b>			
model	version	c.c.	engine
<b>8</b>	Astra (J)	1.3 CDTI ecoFLEX	1248 A13DTE
		1.4 ecoFLEX	A14XEL
			A14XER
			B14XERLDD
		1.4 GPL Turbo	1364 A14NET
		1.4 Turbo	1364 A14NEL
A14NET			
<b>9</b>	Astra Cabrio (G)	2.2	2198 Z22SE
		2.2 DTI	2172 Y22DTR
<b>10</b>	Astra Coupé (G)	2.2	2198 Z22SE
		2.2 DTI	2172 Y22DTR
<b>11</b>	Astra Sedan (G)	1.2	1199 X12XE
			Z12XE
		1.4	1364 Z14XEP
			X20DTL
		2.0 DI	1995 Y20DTL
			1995 Y20DTH
2.2	2198 Z22SE		
	2172 Y22DTR		
<b>12</b>	Astra Sedan (H)	1.3 CDTI	1248 Z13DTH
<b>13</b>	Astra Sedan (J)	1.3 CDTI	1248 A13DTE
		1.4	A14XER
			B14XERLDD
			A14NET
		1.4 GPL	1364 A14NEL
<b>14</b>	Astra Sports Tourer (J)	1.4 Turbo	1364 A14NET
			B14NEL
		1.3 CDTI ecoFLEX	1248 A13DTE
			1398 A14XER
<b>15</b>	Astra Station wagon (G)	1.2	1199 X12XE
			Z12XE
		1.4	1364 Z14XEP
			X20DTL
		2.0 DI	1995 Y20DTL
			1995 Y20DTH
2.2	2198 Z22SE		
2.2 DTI	2172 Y22DTR		

**MOTORI PER MODELLO**

**ENGINE PER MODEL**

OPEL				
				
	model	version	c.c.	engine
16	Astra Station wagon (H)	1.3 CDTI	1248	Z13DTH
		1.4	1364	Z14XEL
				Z14XEP
	1.4 ecoFLEX	1364	Z14XEP	
17	Astra Van (G)	2.0 DI	1995	X20DTL
18	Astra Van (H)	1.3 CDTI	1248	Z13DTH
19	Astra Classic (F 68)	1.2 i	1199	X12XE
		2.0 DI	1995	X20DTL
20	Astra Classic Station wagon (F 35)	1.4 Comfort	1364	Z14XEP
21	Astra GTC (H)	1.2	1199	X12XE
			1229	Z12XEP
		1.3 CDTI	1248	Z13DTH
		1.4	1364	Z14XEL
Z14XEP				
22	Astra GTC (J)	1.4	1364	A14NEL
			B14NEL	
			1398	A14XER
			B14XERLDD	
		1.4 Turbo	1364	A14NET
		B14NET		
		2.0	1998	A20NFT
			B20NFT	
23	Cascada	1.4	1364	A14NEL
			A14NET	
		1.4 Turbo	1364	B14NELLUH
			B14NETLUJ	
		1.4 Turbo GPL	1364	B14NELLUH
B14NETLUJ				
24	Combo Cab. (X12)	1.3 CDTI	1248	A13FD
25	Combo Tour (F06)	1.4	1364	Z14XEP
26	Combo Tour (X12)	1.3 CDTI	1248	A13FD
27	Combo Van (F25)	1.4	1364	Z14XEP
28	Combo Van (X12)	1.3 CDTI	1248	A13FD
29	Corsa (B)	1.0 i	973	X10XE
		1.2 i	1199	X12XE
30	Corsa (C F08-68)	1.0	973	Z10XE
			998	Z10XEP
		1.2	1199	Z12XE
		1.2 Twinport	1229	Z12XEP
			Z13DT	
		1.3 CDTI	1248	Z13DTJ
1.4 Twinport	1364	Z14XEP		

OPEL				
				
	model	version	c.c.	engine
31	Corsa (D L08)	1.0	998	A10XEP
				Z10XEP
		1.2	1229	A12XEL
				A12XER
				Z12XEP
				Z12XEP
		1.2 ecoFLEX	1229	Z12XEP
		1.2 GPL	1229	A12XER
		Z12XEP		
		1.3 CDTI	1248	A13DTC
				A13DTE
				A13DTR
Z13DTE				
Z13DTH				
Z13DTJ				
1364	Z14XEP			
1398	A14XEL			
A14XER				
1.4	1364	Z14XEP		
		A14XEL		
1.4 GPL	1398	Z14XEP		
		A14XEL		
1.4 Turbo	1364	A14NEL		
32	Corsa (E)	1.2	1229	B12XEL
			1398	B14XEJ
		1.4	1398	B14XEL
			1398	B14XEL
		1.4 Turbo	1364	B14NEH
B14NEJ				
33	Corsa Van (C F08-W5L)	1.2	1199	Z12XE
			1229	Z12XEP
		1.3 CDTI	1248	Z13DT
		1.4	1364	Z14XEP
34	Corsa Van (D L08)	1.0	998	A10XEP
				Z10XEP
		1.2	1229	A12XEL
				A12XER
				Z12XEP
				Z12XEP
		1.3 CDTI	1248	A13DTC
				A13DTE
				A13DTR
				Z13DTE
				Z13DTH
				Z13DTJ
1.2	1229	B12XEL		
		B14XEJ		
1.4	1398	B14XEL		
		B14XEL		
35	Corsa Van (E)	2.2 DTI	2171	X22DTH
36	Frontera (B 6B)	2.0	1998	Z20NHH
37	GT Cabrio (ER)			



**MOTORI PER MODELLO**



**ENGINE PER MODEL**





OPEL				
model	version	c.c.	engine	
38	Insignia (A)	1.4	A14NET	
			B14NET	
		1.4 GPL	A14NET	
			B14NET	
		1.4 Turbo	A14NET	
			B14NET	
	2.0 CNG Turbo	1998	A20NFT	
	2.0 Turbo	1998	A20NFT	
			A20NHT	
	2.0 Turbo 4x4	1998	A20NFT	
			A20NHT	
	39	Insignia Sedan (A)	1.4	A14NET
B14NET				
1.4 GPL			1364	A14NET
				B14NET
1.4 Turbo			1364	A14NET
				B14NET
2.0 CNG Turbo		1998	A20NFT	
2.0 Turbo		1998	A20NFT	
			A20NHT	
2.0 Turbo 4x4		1998	A20NFT	
			A20NHT	
40		Insignia Sports Tourer (A)	1.4	A14NET
	B14NET			
	1.4 GPL		1364	A14NET
				B14NET
	1.4 Turbo		1364	A14NET
				B14NET
	2.0 CNG Turbo	1998	A20NFT	
	2.0 Turbo	1998	A20NFT	
			A20NHT	
	2.0 Turbo 4x4	1998	A20NFT	
			A20NHT	
	41	Meriva (A E75)	1.3 CDTI	Y13DT
Z13DT				
Z13DTJ				
1.4 ecoFLEX			1364	Z14XEP
1.4 Twinport			1364	Z14XEP

OPEL				
model	version	c.c.	engine	
42	Meriva (B)	1.3 CDTI	1248	
			A13DTC	
		1.4	1364	A13DTE
				A14NET
		1.4	1398	B14NET
				A14XER
	1.4 ecoFLEX	1364	B14XER	
			A14NEL	
	1.4 GPL	1364	A14NEL	
			B14NEL	
	43	Mokka	1.4	1364
				A14NET
1.4 4x4			1364	B14NET
		A14NET		
1.4 GPL		1364	B14NET	
			A14NET	
	B14NET			
44	Mokka X	1.4 4x4 X	1364	
			A14NET	
	1.4 X	1364	B14NET	
			A14NET	
45	Omega (B)	2.0 DTI	1995	
		X20DTH		
46	Omega Station wagon (B)	2.2 DTI	2171	
		Y22DTH		
47	Signum (F48)	2.2 DTI	2172	
		Y22DTR		
48	Sintra (DU0)	2.0 DTI	1995	
		X20DTH		
49	Speedster Cabrio (R97)	2.0 Turbo	1998	
		Z20NET		
50	Tigra Twin Top (R97)	2.2 direct	2198	
		Z22YH		
51	Vectra (B 36)	2.2 DTI	2171	
		Y22DTR		
52	Vectra (B 38)	2.2 DTI	2171	
		X22DTH		
53	Vectra (B 38)	2.2	2198	
		Z22SE		
54	Vectra (B 38)	1.3 CDTI	1248	
		Z13DT		
55	Vectra (B 38)	1.4	1364	
		Z14XEP		
56	Vectra (B 38)	2.0 DI	1995	
		X20DTL		
57	Vectra (B 38)	2.0 DTI	1995	
		X20DTH		
58	Vectra (B 38)	2.0 DTI	1995	
		Y20DTH		
59	Vectra (B 38)	2.2 DTI	2172	
		Y22DTR		
60	Vectra (B 38)	2.2 i	2198	
		Z22SE		
61	Vectra (B 38)	2.0 DI	1995	
		X20DTL		
62	Vectra (B 38)	2.0 DTI	1995	
		X20DTH		
63	Vectra (B 38)	2.2 DTI	2172	
		Y22DTR		
64	Vectra (B 38)	2.2 i	2198	
		Z22SE		

**MOTORI PER MODELLO**

**ENGINE PER MODEL**

OPEL				
				
	model	version	c.c.	engine
53	Vectra (C F69)	2.0 DTI	1995	Y20DTH
		2.0 Turbo	1998	Z20NET
		2.2	2198	Z22SE
		2.2 direct	2198	Z22YH
		2.2 DTI	2172	Y22DTR
54	Vectra (C GTS)	2.0 DTI	1995	Y20DTH
		2.0 Turbo	1998	Z20NET
		2.2	2198	Z22SE
		2.2 direct	2198	Z22YH
		2.2 DTI	2172	Y22DTR
55	Vectra Station wagon (B 31)	2.0 DI	1995	X20DTL
		2.0 DTI	1995	X20DTH
		2.2 DTI	2172	Y22DTR
		2.2 i	2198	Z22SE
56	Vectra Station wagon (C F35)	2.0 DTI	1995	Y20DTH
		2.0 Turbo	1998	Z20NET
		2.2 direct	2198	Z22YH
		2.2 DTI	2172	Y22DTR
57	Vivaro Bus (J7)	2.0 CDTI	1995	M9R630
				M9R692
				M9R780
				M9R782
				M9R784
				M9R786
				M9R788
58	Vivaro Cab. (E7)	2.0 CDTI	1995	M9R630
				M9R692
				M9R780
				M9R782
				M9R784
				M9R786
				M9R788
59	Vivaro Furg. (F7)	2.0 CDTI	1995	M9R630
				M9R692
				M9R780
				M9R782
				M9R784
				M9R786
60	Zafira (A F75)	2.0 DI	1995	X20DTL
		2.0 DTI	1995	X20DTH
		2.2	2198	Z22SE
		2.2 DTI	2172	Y22DTR
		2.2	2198	Z22YH

OPEL						
						
	model	version	c.c.	engine		
62	Zafira (C P12)	1.4	1364	A14NEL		
				A14NET		
				B14NEL		
				B14NET		
		1.4 GPL	1364	A14NET		
				B14NET		
PEUGEOT						
						
	model	version	c.c.	engine		
1	1007 (KM)	1.6 HDi	1560	9HZDV6TED4		
2	107 (PA)	1.0	998	1KR384F		
				384F		
				CFA384F		
3	108	1.0 VTi	998	1KRFE		
4	2008 (CU)	1.6 Vti	1598	5FSEP6C		
5	205 (I)	1.0	954	108CXV8		
				1.1	1124	109FXW7
				1.4	1360	150XY6B
6	205 (II 20A)	1.2	1204	F1		
				1.4	1360	150XY6B
7	206 (2A-2C)	1.6 HDi	1560	9HYDV6TED4		
				9HZDV6TED4		
8	206 Break (2E-K)	1.6 HDi	1560	9HYDV6TED4		
				9HZDV6TED4		
9	206 CC (2D)	1.6 HDi	1560	9HZDV6TED4		
10	207 (WA-C)	1.4	1397	8F01EP3C		
				8FPEP3C		
				8FREP3		
				8FSEP3		
				EP3		
				EP3C		
		1.6 HDi	1560	9HVDV6TED4		
				9HXDV6ATED4		
				9HYDV6TED4		
				9HZDV6TED4		
1.6 RC	1598	5FYEP6DTS				
		5FREP6DT				
1.6 Turbo	1598	5FXEP6DT				
		5FSEP6C				
1.6 Vti	1598	EP6				

**MOTORI PER MODELLO**

**ENGINE PER MODEL**

PEUGEOT					
model	version	c.c.	engine		
11	207 Break (WK)	1.4	8F01EP3C		
			8FPEP3C		
			8FREP3		
			8FSEP3		
			EP3		
			EP3C		
	1.6	5FSEP6C			
		EP6			
		1.6 HDi	9HVDV6ATED4		
			9HXDV6ATED4		
			9HYDV6ATED4		
1.6 RC	1598	9HZDV6ATED4			
1.6 THP CC	1598	5FYEP6DTS			
12	207 C+C (WD)	1.6	5FSEP6C		
			EP6		
		1.6 HDi	1560	9HZDV6ATED4	
1.6 Turbo	1598	5FREP6DT			
13	207 Van	1.6 HDi	5FXEP6DT		
			9HVDV6ATED4		
14	208 (CA-CC-CK-CL)	1.4	9HXDV6ATED4		
			8FPEP3C		
		1.4 VTi GPL	1397	EP3C	
		1.6	1598	5FSEP6C	
			5FUEP6CDTX		
1.6 THP	1598	EP6CDT			
15	3008	1.6 THP	5GZEP6FDT		
			5G02EP6FDTM		
			5G02EP6FDTMD		
			5GXEP6FDTMD		
			5GYEP6FDTM		
16	3008 (5F)	1.6 THP	5GZEP6FDT		
			1.6 HDi	1560	9HZDV6ATED4
			1.6 THP	1598	5FVEP6CDT
				5FVEP6DT	
				5FXEP6DT	
				5GZEP6FDT	
			1.6 Vti	1598	5FSEP6C
				EP6	
			2.0 HDi	1997	RHDDW10CTED4
				RHEDW10CTED4	
				RHHDW10CTED4	
RHCDW10CTED4					
2.0 HDi Hybrid4	1997	RHHDW10CTED4			

PEUGEOT					
model	version	c.c.	engine		
17	307 (3A-C)	1.6 HDi	1560	9HVDV6ATED4	
			9HVDV6ATED4		
			9HXDV6ATED4		
			9HYDV6ATED4		
			9HZDV6ATED4		
			RHFDW10BTED4		
2.0 HDi	1997	RHRDW10BTED4			
	18	307 Break (3E)	1.6 HDi	1560	9HVDV6ATED4
9HYDV6ATED4					
9HZDV6ATED4					
2.0 HDi			1997	RHRDW10BTED4	
19	307 C+C (3B)	2.0 HDi	1997	RHRDW10BTED4	
20	307 Station wagon (3H)	1.6 D	1560	9HVDV6ATED4	
			9HXDV6ATED4		
		1.6 HDi	1560	9HYDV6ATED4	
2.0 HDi	1997	9HZDV6ATED4			
21	308 (4A-C)	1.6	1598	RHRDW10BTED4	
			8FREP3		
			8FREP3C		
			8FSEP3		
			EP3		
			5F04EP6CDT		
			5FTEP6DT		
			5FVEP6DT		
			5FXEP6DT		
			5FYEP6DTS		
			EP6		
EP6CDT					
1.6 GTi	1598	EP6CDTX			
2.0 HDi	1560	9HVDV6ATED4			
	9HXDV6ATED4				
	9HZDV6ATED4				
	RH02DW10CTED4				
	RHDDW10CTED4				
	RHEDW10CTED4				
2.0 HDi	1997	RHFDW10BTED4			
	RHHDW10CTED4				
	RHRDW10BTED4				
	5FAEP6CDT				
22	308 (LA-LC)	1.6	1598	5FVEP6CDT	
			5FVEP6DT		
			1.6 GTi	1598	EP6FDR5GN
			5FVEP6DT		
			5G02EP6FDTMD		
1.6 THP	1598	EP6FDTX			

**MOTORI PER MODELLO**

**ENGINE PER MODEL**

PEUGEOT							
model	version	c.c.	engine				
23	308 Break (4E)	1.4	1397	8FREP3			
				8FREP3C			
				8FSEP3			
	1.6	1598	5F04EP6CDT	5FTEP6DT	5FXEP6DT		
			5FYEP6DTS	EP6	EP6CDT		
			1.6 HDi	1560	9HVDV6ATED4	9HVDV6TED4	9HXDV6ATED4
					9HZDV6TED4	RH02DW10CTED4	RHDDW10CTED4
					RHEDW10CTED4	RHFWD10BTED4	RHHDW10CTED4
			2.0 HDi	1997	RHRDW10BTED4	RHDDW10CTED4	RHEDW10CTED4
	RHFWD10BTED4	RHHDW10CTED4			RHRDW10BTED4		
	RHDDW10CTED4	RHEDW10CTED4			RHRDW10BTED4		
	308 Break (LH)	1.6 THP	1598	5F02EP6CDT	5FVEP6DT		
				5GTEP6FDTX	5FSEP6C	5FTEP6DT	
				5FXEP6DT	EP6	EP6CDT	
	25	308 C+C (4B)	1.6	1598	EP6CDT		
EP6CDTX					RH02DW10CTED4	RHDDW10CTED4	
RHEDW10CTED4					RHFWD10BTED4	RHHDW10CTED4	
RHRDW10BTED4					2.0 HDi	1997	RHDDW10CTED4
RHFWD10BTED4		RHHDW10CTED4	RHRDW10BTED4				
RHDDW10CTED4		RHEDW10CTED4	RHRDW10BTED4				
RHCDW10CTED4		1.6 HDi	1560	9HYDV6TED4			9HZDV6TED4
RH01DW10BTED4				RHEDW10CTED4	RHFWD10BTED4		
RHHDW10CTED4	RHLDW10BTED4			RHRDW10BTED4			
RHDDW10CTED4	RHEDW10CTED4			RHRDW10BTED4			
26	407 (6D)	2.0 HDi	1997	RHDDW10CTED4	RHEDW10CTED4		
				RHFWD10BTED4	RHHDW10CTED4	RHLDW10BTED4	
				RHRDW10BTED4	RHDDW10CTED4	RHEDW10CTED4	
				RHFWD10BTED4	RHHDW10CTED4	RHRDW10BTED4	
				RHDDW10CTED4	RHEDW10CTED4	RHRDW10BTED4	
				RHCDW10CTED4	1.6 HDi	1560	9HZDV6TED4
RHEDW10CTED4	RHHDW10CTED4	RHRDW10BTED4					
27	407 Break (6E)	2.0 HDi	1997	RHDDW10CTED4	RHEDW10CTED4		
				RHFWD10BTED4	RHHDW10CTED4	RHLDW10BTED4	
				RHRDW10BTED4	RHDDW10CTED4	RHEDW10CTED4	
				RHFWD10BTED4	RHHDW10CTED4	RHRDW10BTED4	

PEUGEOT								
model	version	c.c.	engine					
28	407 Coupé (6C)	2.0 HDi	1997	RHEDW10CTED4				
				RHHDW10CTED4				
				RHRDW10BTED4				
29	5008 (DW)	2.0 HDiF	1997	RHRDW10BTED4				
				5FSEP6C				
		1.6	1598	5FVEP6CDT	EP6	EP6CDT		
				1.6 HDi	1560	9HZDV6TED4	1.6 THP	1598
						5GZEP6FDT	RHDDW10CTED4	RHEDW10CTED4
		2.0 HDi	1997	RHFWD10BTED4	RHHDW10CTED4	RHRDW10BTED4		
				RHDDW10CTED4	RHEDW10CTED4	RHRDW10BTED4		
				RHDDW10CTED4	RHEDW10CTED4	RHRDW10BTED4		
				RHDDW10CTED4	RHEDW10CTED4	RHRDW10BTED4		
		30	5008 (MY2016)	1.6 THP	1598	5G02EP6FDTM		
5GZEP6FDT	EP6FDTMD							
5GZEP6FDT	5FNEP6CDT							
31	508 (8D)	1.6 THP	1598	5GYEP6FDTM				
				5GZEP6FDT	EP6CDT			
				5FSEP6C	EP6C5FH			
		2.0 HDi	1997	RHDDW10CTED4	RHFWD10BTED4	RHHDW10CTED4		
				RHRDW10BTED4	2.0 HDi Hybrid4 AWC	1997		
				RHCDW10CTED4	1.6 THP	1598	5FNEP6CDT	5GYEP6FDTM
5GZEP6FDT	EP6CDT							
5FSEP6C	EP6C5FH							
32	508 Break (8E-8U)	1.6 Vti	1598	RHDDW10CTED4				
				RHFWD10BTED4	RHHDW10CTED4			
				RHRDW10BTED4	2.0 HDi	1997	RHDDW10CTED4	RHEDW10CTED4
		RHFWD10BTED4	RHHDW10CTED4	RHRDW10BTED4				
		RHDDW10CTED4	RHEDW10CTED4	RHRDW10BTED4				
		33	607 (9D-U)	2.0 HDi	1997	RHCDW10CTED4		
RHDDW10CTED4	RHLDW10BTED4							

**MOTORI PER MODELLO**



**ENGINE PER MODEL**



PEUGEOT						
model	version	c.c.	engine			
34	807 (EA-B)	2.0 HDi	1997	RH02DW10CTED4		
				RHDDW10CTED4		
				RHHDW10CTED4		
				RHKDW10UTED4		
				RHRDW10BTED4		
		2.2 HDiF	2179	4HZDW12TED4		
35	Bipper Tepee (AA-)	1.3 HDi	1248	199A9000		
				FHYF13DTE6		
				FHZF13DTE5		
36	Bipper Van (AA-)	1.3 HDi	1248	199A9000		
				FHZF13DTE5		
37	Boxer Bus (YA-B)	2.2 HDi	2198	4HGP22DTE		
				4HHP22DTE		
				4HJP22DTE		
				4HUP22DTE		
				4HVP22DTE		
		3.0 Hdi	2999	F1CE0481DF30DT		
38	Boxer Cab. (YA-B)	2.2 HDi	2198	4HGP22DTE		
				4HHP22DTE		
				4HJP22DTE		
				4HUP22DTE		
				4HVP22DTE		
		3.0 Hdi	2999	F1CE0481DF30DT		
39	Boxer Furg. (YA-B)	2.2 HDi	2198	4HGP22DTE		
				4HHP22DTE		
				4HJP22DTE		
				4HUP22DTE		
				4HVP22DTE		
		3.0 Hdi	2999	F1CE0481DF30DT		
40	Expert Bus (VF3V)	1.6 HDi	1560	9HUDV6UTED4		
				AHYDW10CE		
		2.0 HDi	1997	AHZDW10CD		
				RH02DW10CTED4		
				RHGDW10UTED4		
				RHHDW10CTED4		
				RHKDW10UTED4		
				RHRDW10BTED4		
				2.0 HDi 4x4	1997	RHKDW10UTED4



PEUGEOT								
model	version	c.c.	engine					
41	Expert Cab. (VF3)	1.6 HDi	1560	9HUDV6UTED4				
		2.0 HDi	1997	AHZDW10CD				
				RH02DW10CTED4				
				RHHDW10CTED4				
				RHKDW10UTED4				
				RHRDW10BTED4				
42	Expert Furg. (VF3A-U-X)	1.6 HDi	1560	9HUDV6UTED4				
		2.0 HDi	1997	AHYDW10CE				
				AHZDW10CD				
				RH02DW10CTED4				
				RHGDW10UTED4				
				RHHDW10CTED4				
43	Partner Cab.	1.6 HDi	1560	RHKDW10UTED4				
				RHRDW10BTED4				
				9HSDV6TED4BU				
				9HXDV6ATED4				
				44	Partner Multispace (5F)	1.6 HDi	1560	9H02DV6B
								9HWDV6B
45	Partner Tepee (B9)	1.6	1598	9HXDV6ATED4				
				5F01EP6C				
				5FKEP6CB				
		1.6 HDi	1560	5FSEP6C				
				EP6C5FK				
				9H01DV6TED4				
46	Partner Van (5B)	1.6 HDi	1560	9H02DV6B				
				9HWDV6B				
				9HXDV6ATED4				
				9HZDV6TED4				
				1.6	1598	9H02DV6B		
						9HTDV6BUTED4		
9HVDV6TED4								
47	Partner Van (B9)	1.6	1598	9HXDV6ATED4				
				9H02DV6B				
				9HWDV6B				
		1.6 HDi	1560	5F01EP6C				
				5FKEP6CB				
				5FSEP6C				
48	Ranch Multispace (5F)	1.6 HDi	1560	EP6C5FK				
				9HSDV6TED4BU				
				9HTDV6BUTED4				
				9HXDV6ATED4				
				9HXDV6AUTED4				
				9HZDV6TED4				
9H02DV6B	9HWDV6B	9HXDV6ATED4						

**MOTORI PER MODELLO**

**ENGINE PER MODEL**

PEUGEOT				
				
	model	version	c.c.	engine
49	Ranch Van (5B)	1.6 HDi	1560	9H02DV6B
				9HWDV6B
				9HXDV6ATED4
50	RCZ Coupé (RH)	1.6	1598	5FGEP6CDTR
				EP6CDT
				EP6CDTX
		1.6 THP	1598	5FEEP6CDTMD
				5FMEP6CDTM
				EP6CDTM5FM
		2.0 HDi	1997	RHHDW10CTED4

RENAULT						
						
	model	version	c.c.	engine		
1	4 (112)	1.0	956	689710		
				C1C708		
2	4 Furg. (R21-R23)	1.0	956	C1C708		
3	5 (122)	1.0	956	689710		
4	5 Furg. (238)	1.0	956	689710		
5	Espace (IV JK0)	2.0 dCi	1995	M9R740		
				M9R750		
				M9R760		
				M9R761		
				M9R762		
				M9R763		
				M9R802		
				M9R814		
				M9R815		
				M9R858		
				2.0 dCi 175 FAP	1995	M9R812K8
				M9R815		
				M9R859		
				M9R700		
6	Grand Scenic (II JMO)	2.0 dCi	1995	M9R721		
				M9R722		
				M9RA700		
				M9R610		
7	Grand Scenic (III JZ0)	2.0 dCi	1995	M9R615		

RENAULT				
				
	model	version	c.c.	engine
8	Koleos (HY)	2.0 dCi	1995	M9R830
				M9R834V8
				M9R83528
				M9R836H8
				M9R855
				M9R856
				M9R862
				M9R864
				M9R865
				M9R866
				M9RD833
				M9RG832
				M9R830
				M9R832
M9R855				
M9R856				
M9R862				
M9R865				
M9R866				
9	Laguna (II BG0)	2.0 dCi	1995	M9R740
				M9R760
				M9RA700
10	Laguna (III BT0)	2.0 dCi	1995	M9R742
				M9R744
				M9R800
				M9R802
				M9R805
				M9R806
				M9R808
				M9R809
				M9R814
				M9R815
				M9R845
				M9R849
				M9R857
				M9R858
M9RA742				
M9RK800				
M9RK802				
2.0 dCi GT	1995	M9R816		
11	Laguna Grandtour (II KG0)	2.0 dCi	1995	M9R740
				M9R760
				M9RA700

**MOTORI PER MODELLO**

**ENGINE PER MODEL**

RENAULT						
	model	version	c.c.	engine		
12	Laguna Grandtour (III KTO)	2.0 dCi	1995	M9R742		
				M9R744		
				M9R800		
				M9R802		
				M9R805		
				M9R806		
				M9R808		
				M9R809		
				M9R814		
				M9R815		
				M9R845		
				M9R849		
				M9R857		
				M9R858		
				M9RA742		
				M9RK800		
				M9RK802		
						2.0 dCi GT
						M9R820
13	Latitude (L70)	2.0 dCi	1995	M9R756		
				M9R824		
				M9R846		
				2.0 dCi 175	1995	M9R804
		M9R811				
		M9R817				
		M9R839				
				M9R844		
14	Megane (II BM-CM0)	2.0 dCi	1995	M9R700		
				M9R722		
				M9R724		
				M9RA700		
15	Megane (III BZ0)	2.0 dCi	1995	M9R610		
				M9R615		
16	Megane C+C (II EM0)	2.0 dCi	1995	M9R700		
				M9R722		
				M9RA700		
17	Megane C+C (III EZ0)	2.0 dCi	1995	M9R610		
				M9R615		
18	Megane Coupé (III DZ0)	2.0 dCi	1995	M9R610		
				M9R615		
19	Megane Grandtour (II KM0)	2.0 dCi	1995	M9R700		
				M9R722		
				M9RA700		
20	Megane Grandtour (III KZ0)	2.0 dCi	1995	M9R610		
				M9R615		

RENAULT				
	model	version	c.c.	engine
21	Megane Sedan (II LM0)	2.0 dCi	1995	M9R700
				M9R722
				M9RA700
22	Scenic (II JM0)	2.0 dCi	1995	M9R700
				M9R721
				M9R722
				M9RA700
23	Scenic Xmod (III JZ0)	2.0 dCi	1995	M9R610
				M9R615
24	Trafic Bus (II JL)	2.0 dCi	1995	M9R630
				M9R692
				M9R780
				M9R782
				M9R784
				M9R786
				M9R786
25	Trafic Cab. (II EL)	2.0 dCi	1995	M9R630
				M9R692
				M9R780
				M9R782
				M9R784
				M9R786
26	Trafic Furg. (II FL)	2.0 dCi	1995	M9R630
				M9R692
				M9R780
				M9R782
				M9R784
				M9R786
27	Vel Satis (BJ0)	2.0 dCi	1995	M9R760
				M9R762
				M9R763

SEAT				
	model	version	c.c.	engine
1	Alhambra (710)	1.4 TSI	1390	CAVA
				CNWB
				CTHA
2	Altea (5P1)	1.2 TSI	1197	CBZB
		1.4 TSI	1390	CAXC
3	Altea XL (5P5)	1.2 TSI	1197	CBZB
		1.4 TSI	1390	CAXC
4	Arosa (6H)	1.4 TDI	1422	AMF

**MOTORI PER MODELLO**

**ENGINE PER MODEL**

SEAT				
model	version	c.c.	engine	
5	Cordoba (6L2)	1.2	1198	AZQ
				BME
				BXV
	1.4 TDI	1422	AMF	
			BMS	
			BNM	
			BNV	
	1.6	1598	BTS	
	6	Ibiza (IV 6L1)	1.2	1198
BBM				
BME				
1.4 TDI		1422	BXV	
			AMF	
			BMS	
			BNM	
1.6		1598	BNV	
			BTS	
7	Ibiza (V 6J5-6P1)	1.2	1198	BBM
				BXV
				BZG
				CGPA
				CGPB
				CJLB
		1.2 TSI	1197	CBZA
				CBZB
		1.4	1390	CAVE
		1.4 TDI	1422	BMS
		1.4 TSI	1390	CAVF
				CNUB
CTHF				
CTJB				
1.6	1598	BTS		
1.6 GPL	1598	CNKA		

SEAT				
model	version	c.c.	engine	
8	Ibiza Sportcoupé (V 6J1-6P5)	1.2	1198	BBM
				BXV
				BZG
				CGPA
				CGPB
				CJLB
		1.2 TSI	1197	CBZA
				CBZB
		1.4 TDI	1422	BMS
		1.4 TSI	1390	CAVE
				CAVF
				CNUB
CTHE				
1.6	1598	CTHF		
		CTJB		
1.6 GPL	1598	CTJC		
		BTS		
9	Ibiza Station wagon (V 6J8-6P8)	1.2	1198	BBM
				BXV
				BZG
				CGPA
				CGPB
				CJLB
		1.2 TSI	1197	CBZA
				CBZB
		1.4	1390	CAVE
		1.4 TSI	1390	CAVF
				CNUB
				CTHF
CTJB				
1.6	1598	BTS		
1.2 TSI	1197	CBZB		
		CAXC		
1.4 TSI	1390	CAXC		
		CGPC		
12	Toledo (IV)	1.2	1198	CBZA
				CBZB
		1.4 TSI	1390	CAXA
				1.6



**MOTORI PER MODELLO**



**ENGINE PER MODEL**





SKODA					
model	version	c.c.	engine		
1	Fabia (542)	1.2	1198	BBM	
				BMD	
				BZG	
				CEVA	
				CGPA	
				CGPB	
				CHTA	
	1.2 TSI	1197	CBZA		
			CBZB		
			1.4 TDI	1422	BMS
					BNM
					BNV
			2	1.2	1198
AZQ					
BMD					
1.4 TDI	1422	BME			
		AMF			
		BNM			
3	1.2	1198	BNV		
			AWY		
			AZQ		
	1.4 TDI	1422	BMD		
			BME		
			AMF		
4	Fabia Station wagon (545)	1.2	1198	BBM	
				BZG	
				CEVA	
				CGPA	
				CGPB	
				CHTA	
				CBZA	
	1.2 TSI	1197	CBZB		
			1.4 TDI	1422	BMS
	BNM				
	BNV				
	BNV				

SKODA						
model	version	c.c.	engine			
5	Fabia Station wagon (6Y5)	1.2	1198	AWY		
				AZQ		
				BMD		
		1.4 TDI	1422	BME		
				AMF		
				BNM		
6	Octavia (1Z3)	1.2 TSI	1197	BNV		
				CBZB		
		1.4 TSI	1390	CAXA		
				1.6 FSI	1598	BLF
		7	Octavia Station wagon (1Z5)	1.2 TSI	1197	CBZB
				1.4 TSI	1390	CAXA
1.6 FSI	1598			BLF		
8	Rapid (NH)	1.2	1198	CGPC		
		1.2 TSI	1197	CBZA		
9	Rapid Sportback (NH)	1.2	1198	CBZB		
		1.2 TSI	1197	CBZB		
10	Roomster (5J)	1.2	1198	BME		
				BZG		
				CGPA		
		1.2 TSI	1197	CBZA		
				CBZB		
		1.4 TDI	1422	BMS		
11	Superb (3T4)	1.4 TSI	1390	BNM		
				BNV		
12	Superb Station wagon (3T5)	1.4 TSI	1390	BTS		
				CFNA		
13	Yeti (5L)	1.2 TSI	1197	CAXC		
		1.4 TSI	1390	CBZB		

**MOTORI PER MODELLO**



**ENGINE PER MODEL**





<b>SMART</b>				
				
	model	version	c.c.	engine
1	Cabrio Cabrio (450)	0.6	599	M160910
				M160920
				M160E6ALB03
		0.7	698	M160910
				M160920
				M160E6ALB05
0.8 CDI	799	OM660940		
		OM660DE8LA		
2	City-Coupè (450)	0.6	599	M160910
				M160920
				M160E6ALB03
		0.7	698	M160E6ALB04
				M160E6ALB05
				M160910
0.8 CDI	799	M160920		
		OM660940		
3	Crossblade Cabrio (450)	0.6	599	OM660DE8LA
				M160910
4	Forfour (454)	1.5 CDI	1493	M160920
				OM639939
5	Fortwo Cabrio (I 450)	0.7	698	M160910
				M160920
		0.7 BRABUS	698	M160920
				OM660940
0.8 CDI	799	OM660DE8LA		
		OM660951		
6	Fortwo Cabrio (II 451)	0.8 CDI	799	M132910
				M132930
		1.0	999	M132930
				M132930
7	Fortwo Coupé (I 450)	0.7	698	M160910
				M160920
		0.7 50	698	M160910
				M160920
0.8 CDI	799	OM660940		
		OM660DE8LA		
8	Fortwo Coupé (II 451)	0.8 CDI	799	OM660950
				OM660951
		1.0	999	M132910
				M132930
1.0 Turbo	999	M132930		
		M132930		
9	Roadster Cabrio (452)	0.7	698	M160921
				M160922
				M160923

<b>SMART</b>				
				
	model	version	c.c.	engine
10	Roadster Coupé (452)	0.7	698	M160921
				M160922
		0.7 BRABUS	698	M160923
<b>SUZUKI</b>				
				
	model	version	c.c.	engine
1	Grand Vitara (II JT)	1.6	1586	M16A
		1.6 4x4	1586	M16A
		1.6 Allrad	1586	M16A
2	Ignis (II RM)	1.3 DDiS	1248	Z13DT
3	Liana (ER)	1.3	1328	M13A
		1.6	1586	M16A
		1.6 4WD	1586	M16A
		1.8 i	1796	M18A
4	Liana Sedan	1.3	1328	M13A
		1.6	1586	M16A
		1.6 4WD	1586	M16A
		1.6 i	1586	M16A
5	Liana Station wagon (ER)	1.8 i	1796	M18A
		1.3	1328	M13A
				M13A
6	Swift (III EZ-MZ)	1.3 DDiS	1248	D13A
				Z13DT
				Z13DTJ
		1.5	1490	M15A
		1.6	1586	M16A
7	Swift (IV MZ)	1.3 DDiS	1248	D13A
				M15A
8	SX4 (GY)	1.5 VVT	1490	M15A
		1.5 VVTi	1490	M15A
		1.6 VVT	1586	M16A
		1.6 VVT 4x4	1586	M16A
		1.6	1586	M16A
9	SX4 Sedan (GY)	1.6 VVT	1586	M16A
				M16A
10	Wagon R	1.0	998	Z10XEP
		1.2	1229	Z12XEP
11	Wagon R+ (II MM)	1.3 DDiS	1248	Z13DT

**MOTORI PER MODELLO**



**ENGINE PER MODEL**



<b>TOYOTA</b>				
				
	model	version	c.c.	engine
1	Auris (ZE15-RE15)	1.4 VVTi	1398	4ZZFE
2	Avenis (T22)	1.6 VVT-i	1598	3ZZFE
		1.8 VVT-i	1794	1ZZFE
3	Avenis (T25)	1.6 VVT-i	1598	3ZZFE
		1.8	1794	1ZZFE
4	Avenis Sedan (T22)	1.6 VVT-i	1598	3ZZFE
		1.8 VVT-i	1794	1ZZFE
5	Avenis Sedan (T25)	1.6 VVT-i	1598	3ZZFE
		1.8	1794	1ZZFE
6	Avenis Sportwagon (T22)	1.6 VVT-i	1598	3ZZFE
		1.8 VVT-i	1794	1ZZFE
7	Avenis Sportwagon (T25)	1.6 VVT-i	1598	3ZZFE
		1.8	1794	1ZZFE
8	Aygo (B10)	1.0	998	1KRFE
		1.0 GPL	998	1KRFE
9	Aygo (MY2014)	1.0 VVT-i	998	1KRFE
10	Corolla (E11)	1.4	1398	4ZZFE
		1.6	1598	3ZZFE
11	Corolla (E12)	1.4 VVT-i	1398	4ZZFE
		1.6 VVT-i	1598	3ZZFE
12	Corolla Compact (E11)	1.4	1398	4ZZFE
		1.6	1598	3ZZFE
13	Corolla Sedan (E11)	1.4	1398	4ZZFE
		1.6	1598	3ZZFE
14	Corolla Sedan (E12)	1.4 VVT-i	1398	4ZZFE
		1.6 VVT-i	1598	3ZZFE
15	Corolla Sedan (E15)	1.4 VVT-i	1398	4ZZFE
		1.6 CNG	1598	3ZZFE
16	Corolla Station wagon (E11)	1.4	1398	4ZZFE
		1.6	1598	3ZZFE
17	Corolla Station wagon (E12)	1.4 VVT-i	1398	4ZZFE
		1.6 VVT-i	1598	3ZZFE
18	Corolla Verso (E12)	1.4 VVT-i	1398	4ZZFE
		1.6 VVT-i	1598	3ZZFE
		1.8 VVT-i	1794	1ZZFE
		1.8 VVTi 4WD	1794	1ZZFE
19	Corolla Verso (ZER-ZZE)	1.6	1598	3ZZFE
		1.8	1794	1ZZFE
20	Yaris (I P1)	1.0	998	1SZFE
		1.3	1296	2SZFE
		1.4 D-4D	1364	1NDTV

<b>TOYOTA</b>				
				
	model	version	c.c.	engine
21	Yaris (II P9)	1.0 GPL	998	1KRFE
		1.0 VVT-i	998	1KRFE
		1.3 VVT-i	1296	2SZFE
		D-4D	1364	1NDTV
22	Yaris (III P13)	1.0 VVT-i	998	1KRFE
23	Yaris (IV NCP15)	1.0	998	1KRFE
24	Yaris Sedan (ZSP9-NCP9)	1.0	998	1KRFE
<b>VAUXHALL</b>				
				
	model	version	c.c.	engine
1	Adam	1.2	1229	A12XEL
				B12XEL
		1.4	1398	A14XEL
				A14XER
				B14XERLDD
				A14XEL
		1.4 GPL	1398	B14XERLDD
				A14XEL
		1.4 S	1364	B14NEH
				B14NET
1.4 Turbo	1398	B14NEHLUJ		
2	Agila (A)	1.0	973	Z10XE
				Z10XEP
		1.2	1199	Z12XE
				Z12XEP
1.3 CDTI	1248	Z13DT		
		Z13DTJ		
3	Agila (B)	1.3 CDTI	1248	Z13DTJ
4	Ampera	Ampera	1398	A14XFL
5	Antara (J26-H26)	2.4	2384	A24XE
				A24XELE9
6	Astra (G)	1.2	1199	X12XE
				Z12XE
		2.0 DI	1995	X20DTL
				Y20DTL
		2.0 DTI	1995	Y20DTH
				Z22SE
7	Astra (H)	1.2	1229	Z12XEP
				Z13DTH
		1.3 CDTI	1248	Z14XEL
				Z14XEP
8	Astra (J)	1.3 CDTI	1248	A13DTE
				A14XEL
		1.4	1398	A14XER
				B14XERLDD
1.4 Turbo	1364	A14NEL		
		A14NET		

**MOTORI PER MODELLO**



**ENGINE PER MODEL**



VAUXHALL				
				
	model	version	c.c.	engine
9	Astra Cabrio (G)	2.2	2198	Z22SE
10	Astra Coupé (G)	2.2	2198	Z22SE
11	Astra Sedan (G)	1.2	1199	X12XE Z12XE
		2.0 DI	1995	X20DTL Y20DTL
		2.0 DTI	1995	Y20DTH
		2.2	2198	Z22SE
		2.2 DTI	2172	Y22DTR
		1.3 CDTI	1248	A13DTE
12	Astra Sedan (J)	1.4	1398	A14XER B14XERLDD
		1.4 Turbo	1364	A14NET
		1.3 CDTI	1248	Z13DTH
13	Astra Sport Hatch (H)	1.4	1364	Z14XEL Z14XEP
		1.3 CDTI	1248	A13DTE
14	Astra Sports Tourer (J)	1.4	1398	A14XEL A14XER B14XERLDD
		1.4 Turbo	1364	A14NEL A14NET
		1.2	1199	X12XE Z12XE
		2.0 DI	1995	X20DTL Y20DTL
15	Astra Station wagon (G)	2.0 DTI	1995	Y20DTH
		2.2	2198	Z22SE
		1.2	1229	Z12XEP
16	Astra Station wagon (H)	1.3 CDTI	1248	Z13DTH
		1.4	1364	Z14XEL Z14XEP
		2.0 DI	1995	X20DTL
17	Astra Van (G)	2.0 DTI	1995	Y20DTH
		1.3 CDTI	1248	Z13DTH
18	Astra Van (H)	1.4	1364	Z14XEP
		1.4	1398	A14XER
19	Astra GTC (J)	1.4 Turbo	1364	A14NEL A14NET B14NEL B14NET
		2.0 Turbo	1998	A20NFT B20NFT

VAUXHALL						
						
	model	version	c.c.	engine		
20	Cascada	1.4	1364	A14NEL A14NET B14NELLUH B14NET B14NETLUJ		
		1.4 Turbo	1364	B14NELLUH B14NETLUJ		
		1.4 Turbo GPL	1364	B14NETLUJ		
		21	Combo Tour (C)	1.4	1364	Z14XEP
		22	Combo Van (C)	1.4	1364	Z14XEP
		23	Combo Van (D)	1.3 CDTI	1248	A13FD
23	Corsa (B)	1.0 i	973	X10XE		
		1.2 i	1199	X12XE		
24	Corsa (C)	1.0	973 998	Z10XE Z10XEP		
		1.2	1199	Z12XE Z12XEP		
		1.2 Dualfuel	1199	Z12XE		
		1.3 CDTI	1248	Z13DT Z13DTJ		
		1.4	1364	Z14XEP		
		1.0	998	A10XEP Z10XEP		
		1.0 i	998	A10XEP		
		1.2	1229	A12XEL Z12XEP		
25	Corsa (D)	1.2 GPL	1229	A12XER Z12XEP		
		1.2 i	1229	A12XER		
		1.3 CDTI	1248	A13DTC A13DTE A13DTR Z13DTE Z13DTH Z13DTJ		
		1.4	1362 1364	A14NEL Z14XEP		
		1.4	1398	A14XEL A14XER		
		1.4 GPL	1364	Z14XEP		
		1.2	1229	B12XEL		
		1.4	1364	B14NEL		
		1.4	1398	B14XEJ B14XEL		
		1.4 Turbo	1364	B14NEH		

**MOTORI PER MODELLO**

**ENGINE PER MODEL**



VAUXHALL				
				
	model	version	c.c.	engine
26	Corsa Van (C)	1.2	1199	Z12XE
		1.2 Dualfuel	1199	Z12XE
		1.3 CDTI	1248	Z13DT
		1.4	1364	Z14XEP
27	Corsa Van (D)	1.2	1229	A12XEL
				Z12XEP
		1.3 CDTI	1248	A13DTC
				A13DTE
				A13DTR
				Z13DTE
				Z13DTH
				Z13DTJ
28	Corsa Van (E)	1.2	1229	B12XEL
29	Frontera (B)	2.2 DTI	2171	X22DTH
				Y22DTH
30	Insignia	1.4 GPL	1364	A14NET
		1.4 Turbo	1364	A14NET
				B14NET
		2.0 Turbo	1998	A20NFT
		2.0 Turbo 4x4	1998	A20NHT
31	Insignia Sedan	1.4 GPL	1364	A14NET
		1.4 Turbo	1364	A14NET
		2.0 Turbo	1998	A20NFT
				A20NHT
32	Insignia Sports Tourer	1.4 GPL	1364	A14NET
		1.4 Turbo	1364	A14NET
				B14NET
		2.0 Turbo	1998	A20NFT
		2.0 Turbo 4x4	1998	A20NHT
33	Meriva (A)	1.3 CDTI	1248	Y13DT
				Z13DT
				Z13DTJ
		1.4 Twinport	1364	Z14XEP
34	Meriva (B)	1.3 CDTI	1248	A13DTC
				A13DTE
		1.4	1398	A14XER
				B14XER
		1.4 GPL	1364	A14NEL
				B14NEL
		1.4 Turbo	1364	A14NEL
				A14NET
				B14NEL
				B14NET

VAUXHALL				
				
	model	version	c.c.	engine
35	Mokka	1.4	1364	A14NET
				B14NET
		1.4 4x4	1364	A14NET
				B14NET
36	Omega (B)	2.0 DTI	1995	X20DTH
		2.2 DTI	2171	Y22DTH
37	Omega Station wagon (B)	2.0 DTI	1995	X20DTH
		2.2 DTI	2172	Y22DTH
38	Signum	2.0 DTI	1994	Y20DTH
		2.0 i Turbo	1998	Z20NET
		2.2 DTI	2172	Y22DTR
		2.2 i	2198	Z22YH
39	Sintra	2.2 DTI	2171	X22DTH
40	Speedster (VX220)	2.2	2198	Z22SE
41	Tigra Twin Top	1.3 CDTI	1248	Z13DT
		1.4	1364	Z14XEP
42	Vectra (B)	2.0 DI	1995	X20DTL
		2.0 DTI	1995	X20DTH
				Y20DTH
		2.2 DTI	2172	Y22DTR
		2.2 i	2198	Z22SE
43	Vectra (C)	2.0 DTI	1995	Y20DTH
		2.0 Turbo	1998	Z20NET
		2.2	2198	Z22SE
		2.2 direct	2198	Z22YH
		2.2 DTI	2172	Y22DTR
		44	Vectra Sedan (B)	2.0 DI
2.0 DTI	1995			X20DTH
				Y20DTH
2.2 DTI	2172			Y22DTR
2.2 i	2198			Z22SE
45	Vectra Station wagon (B)	2.0 DI	1995	X20DTL
		2.0 DTI	1995	X20DTH
				Y20DTH
		2.2 DTI	2172	Y22DTR
		2.2 i	2198	Z22SE
		46	Vectra Station wagon (C)	2.0 DTI
2.0 Turbo	1998			Z20NET
2.2 direct	2198			Z22YH
2.2 DTI	2172			Y22DTR
47	Vectra GTS (C)	2.0 DTI	1995	Y20DTH
		2.0 Turbo	1998	Z20NET
		2.2	2198	Z22SE
		2.2 direct	2198	Z22YH
		2.2 DTI	2172	Y22DTR



**MOTORI PER MODELLO**

**ENGINE PER MODEL**



**VAUXHALL**

									
model	version	c.c.	engine						
48	Vivaro Bus (J7)	2.0 CDTI	1995	M9R630					
				M9R780					
				M9R782					
				M9R784					
				M9R786					
				M9R788					
49	Vivaro Cab.	2.0 CDTI	1995	M9R630					
				M9R780					
				M9R782					
				M9R786					
				M9R788					
50	Vivaro Furg. (F7)	2.0 CDTI	1995	M9R630					
				M9R692					
				M9R780					
				M9R782					
				M9R786					
51	VX220	2.2 i	2198	Z22SE					
				52	Zafira (A)	1995	2198	2.0 DI	X20DTL
								2.0 DTI	Y20DTH
								2.2	Z22SE
53	Zafira (B)	2.2	2198	2.2 TD	Y22DTR				
				Z22YH					
54	Zafira (P12)	1.4 GPL	1364	A14NET					
				A14NEL					
		1.4 Turbo	1364	A14NET					
				B14NET					

**VOLVO**



				
model	version	c.c.	engine	
1	C30 (MK)	1.6 D	1560	D4164T
		2.0 d	1998	D4204T
2	C70 Cabrio (II P80M)	2.0 d	1997	D4204T
		1.6 D	1560	D4164T
3	S40 (MS)	2.0 d	1998	D4204T
		D4204T2		
4	S80 (AS)	1.6 D DRIVe	1560	D4164T
		2.0 TDi	1997	D4204T
5	V50 Station wagon (MW)	1.6 D	1560	D4164T
		2.0 d	1997	D4204T2
			1998	D4204T
6	V70 (BW)	1.6 D	1560	D4164T
		2.0 d	1997	D4204T

**VOLKSWAGEN**

				
model	version	c.c.	engine	
1	Beetle (II 5C1)	1.2 TSI	1197	CBZB
		CAVD		
		1.4 TSI	1390	CNWA
		CTHD		
		CTKA		
2	Beetle Cabrio (II)	1.2 TSI	1197	CBZB
		CAVD		
		1.4 TSI	1390	CNWA
		CTHD		
3	Caddy Station wagon (2KB-2KJ-2CB-2CJ)	1.2 TSI	1197	CBZA
				CBZB
4	Caddy Van (2KA-2KH-2CA-2CH)	1.2 TSI	1197	CBZA
				CBZB
5	CC (358)	1.4 E85	1390	CKMA
		1.4 TSI	1390	CTHD
6	Eos (1F7-8)	1.4 TSI	1390	CAVD
				CAXA
				CTHD
7	Fox (5Z1-5Z3)	1.6 FSI	1598	BLF
				BMD
8	Golf (V 1K1)	1.2	1198	CHFA
				CHFB
		1.4 TDI	1422	BNM
				BKG
		1.4 FSI	1390	BLN
				BLG
		1.4 TSI	1390	BMV
				CAXA
		1.6 FSI	1598	BAG
				BLP
9	Golf (VI 5K1)	1.2 TSI	1197	CBZA
				CBZB
		1.4 TSI	1390	CAVD
				CAXA
				CNWA
10	Golf Cabrio (VI 517)	1.4 TSI	1390	CTHD
				CTKA
				CBZB
1.2 TSI	1197	CAVD		
		CAXA		
1.4 TSI	1390	CNWA		
		CAVD		

**MOTORI PER MODELLO**



**ENGINE PER MODEL**

VOLKSWAGEN				
				
	model	version	c.c.	engine
11	Golf Variant (V 1K5)	1.4 TSI	1390	BLG
				BMY
				CAVD
				CAXA
12	Golf Variant (VI AJ5)	1.2 TSI	1197	CBZA
				CBZB
		1.4 TSI	1390	CAVD
				CAXA
				CNWA
				CTHD
				CTKA
13	Golf Plus (5M1-521)	1.2 TSI	1197	CBZA
				CBZB
		1.4 FSI	1390	BLN
		1.4 TSI	1390	BLG
				BMY
				CAVD
				CAXA
				CNWA
				CTHD
1.6 FSI	1598	BAG		
		BLF		
		BLP		
14	Jetta (V 1K2)	1.4 TSI	1390	BLG
				BMY
		1.6 FSI	1598	CAVD
				CAXA
15	Jetta (VI 162)	1.2 TSI	1197	CBZB
		1.4 TSI	1390	CAVA
				CAVD
				CAXA
				CMSB
				CTHA
				CTHD
		1.6	1595	CFNA
				1598
		CFNB		
16	Jetta Sportwagen (V 1K5)	1.4 TSI	1390	BLG
				BMY
				CAVD
				CAXA
17	Lupo (6X1-6E1)	1.2 TDI 3L	1191	ANY
		1.4 TDI	1422	AYZ
				AMF

18	Passat (362)	1.4 TSI	1390	CAXA
				CTHD
		1.4 TSI EcoFuel	1390	CDGA
19	Passat (3C2)	1.4 TSI MultiFuel	1390	CKMA
		1.4 TSI	1390	CAXA
		1.4 TSI EcoFuel	1390	CDGA
20	Passat Variant (365)	1.6 FSI	1598	BLF
		1.4 TSI	1390	CAXA
				CTHD
21	Passat Variant (3C5)	1.4 TSI EcoFuel	1390	CDGA
		1.4 TSI MultiFuel	1390	CKMA
		1.4 TSI	1390	CAXA
22	Passat CC (357)	1.6 FSI	1598	BLF
		1.4 TSI EcoFuel	1390	CDGA
23	Polo (III 6N2)	1.4 TSI MultiFuel	1390	CKMA
		1.4 TDI	1422	AMF
24	Polo (IV 9N1)	1.2	1198	AWY
				AZQ
				BBM
				BMD
				BME
				BZG
		1.4 FSI	1390	AXU
		1.4 TDI	1422	AMF
				BAY
				BMS
BNM				
25	Polo (V 6R-6C)	1.6	1598	BNV
				BWB
		1.2	1198	BTS
				CGPA
		1.2 TSI	1197	CGPB
				CJLA
		1.4	1390	CBZB
				CBZC
		1.4 TSI	1390	CDDA
				CLPA
1.6	1598	CAVE		
		CTHE		
26	Polo Sedan (III 9N1)	1.6 BiFuel	1598	CLSA
		1.4 TDI	1422	CNKA
27	Polo Sedan (IV)	1.6	1598	AMF
				BAY
				CFNA
				CFNB
				CLSA

**MOTORI PER MODELLO**

**ENGINE PER MODEL**

<b>VOLKSWAGEN</b>							
							
	model	version	c.c.	engine			
28	Scirocco (III 137)	1.4 TSI	1390	CAXA			
				CMSB			
				CTHD			
				CTKA			
29	Sharan (II 7N)	1.4 TSI	1390	CAVA			
				CTHA			
30	Tiguan (5N)	1.4 TSI	1390	BWK			
				CAVA			
				CAVD			
				CAXA			
				CTHA			
				CTHD			
		1.4 TSI 4motion	1390	BWK			
				CAVA			
				CAVD			
				CTHA			
				CTHD			
31	Touran (I 1T1-1T2)	1.4 FSI	1390	BLG			
		1.4 TSI	1390	BMV			
		1.4 TSI EcoFuel	1390	CAVC			
		1.6 FSI	1598	BAG			
				BLF			
				BLP			
32	Touran (II 1T3)	1.2 TSI	1197	CBZB			
		1.4 TSI	1390	CAVC			
				CTHB			
		1.4 TSI EcoFuel	1390	CTHC			



## KIT TENDICATENA PER MOTORE *TIMING CHAIN KIT PER ENGINE*

<b>ALFA ROMEO</b>	<b>1</b>
<b>AUDI</b>	<b>1</b>
<b>BMW</b>	<b>2</b>
<b>CHEVROLET</b>	<b>3</b>
<b>CITROËN</b>	<b>3</b>
<b>DAIHATSU</b>	<b>5</b>
<b>FIAT</b>	<b>5</b>
<b>FORD</b>	<b>9</b>
<b>HYUNDAI</b>	<b>14</b>
<b>IVECO</b>	<b>15</b>
<b>KIA</b>	<b>17</b>
<b>LADA</b>	<b>17</b>
<b>LANCIA</b>	<b>17</b>
<b>MAZDA</b>	<b>18</b>
<b>MERCEDES</b>	<b>18</b>
<b>MINI</b>	<b>21</b>
<b>MITSUBISHI</b>	<b>21</b>
<b>NISSAN</b>	<b>22</b>
<b>OPEL</b>	<b>22</b>
<b>PEUGEOT</b>	<b>25</b>
<b>RENAULT</b>	<b>27</b>
<b>SEAT</b>	<b>28</b>
<b>SKODA</b>	<b>29</b>
<b>SMART</b>	<b>30</b>
<b>SUZUKI</b>	<b>31</b>
<b>TOYOTA</b>	<b>31</b>
<b>VAUXHALL</b>	<b>31</b>
<b>VOLVO</b>	<b>34</b>
<b>VOLKSWAGEN</b>	<b>34</b>

Questo catalogo contiene dati ed informazioni provenienti dalla pluriennale esperienza di Finimpianti. Tuttavia non possiamo assumere alcuna responsabilità per eventuali dati errati od incompleti.

Tutti i dati e le informazioni contenute nel presente catalogo sono fornite a puro scopo informativo e senza responsabilità e non potranno dare adito ad alcuna forma di risarcimento.

Visto il continuo sviluppo dei nostri prodotti, Finimpianti si riserva il diritto di apportare modifiche senza preavviso.

Denominazioni, numeri e codici originali sono riportati a puro titolo di riferimento.

*All the information and data contained in this catalogue came from the long Finimpianti experience. Nevertheless we can not assume any responsibility for possible mistakes.*

*All the information and data contained in this catalogue are provide "as is" without any representation or warranty express or implied. Under no circumstances whatsoever shall Finimpianti be liable for any damages whatsoever arising out of the use of the information and data contained in this catalogue.*

*Finimpianti does not warrant the accuracy or completeness of the materials and content contained in this catalogue and reserves the right to correct any errors or omissions at any time without notice and without obligation to the users of this catalogue.*

**KIT TENDICATENA PER MOTORE**

**TIMING CHAIN KIT PER ENGINE**

ALFA ROMEO						
engine	c.c.	kw	hp	SRI part number	pcs	
1	199A3000	1248	66	90	SRI000030KSK	15
					SRI030100KSK	9
					SRI031000KSK	25
					SRI031001KSK	26
					SRI03100PKSK	16
					SRI032000KSK	6
					SRI033000KSK	4
					SRI034000KSK	9
2	199B1000	1248	70	95	SRI000030KSK	15
					SRI030100KSK	9
					SRI031000KSK	25
					SRI031001KSK	26
					SRI03100PKSK	16
					SRI032000KSK	6
					SRI033000KSK	4
					SRI034000KSK	9
3	199B4000	1248	62	84	SRI000030KSK	15
					SRI030075KSK	8
					SRI030100KSK	9
					SRI031000KSK	25
					SRI031001KSK	26
					SRI03100PKSK	16
					SRI032000KSK	6
					SRI033000KSK	4
4	199B6000	875	74 77	101 105	SRI030055KSK	6
					SRI031055KSK	4
5	199B8000	1248	59	80	SRI000030KSK	15
					SRI030075KSK	8
					SRI030100KSK	9
					SRI031000KSK	25
					SRI031001KSK	26
					SRI03100PKSK	16
					SRI032000KSK	6
					SRI033000KSK	4
6	312A2000	875	63	86	SRI030055KSK	6
					SRI031055KSK	4
7	330A1000	1248	70	95	SRI000030KSK	15
					SRI030100KSK	9
					SRI031000KSK	25
					SRI031001KSK	26
					SRI03100PKSK	16
					SRI032000KSK	6
					SRI033000KSK	4
					SRI034000KSK	9

ALFA ROMEO						
engine	c.c.	kw	hp	SRI part number	pcs	
8	939A5000	2198	136	185	SRI030065KSK	16
					SRI031065KSK	13
					SRI032058KSK	7
					SRI032065KSK	14
					SRI030065KSK	16
9	939A6000	1859	118	160	SRI031065KSK	13
					SRI032058KSK	7
					SRI032065KSK	14
					SRI030065KSK	16
AUDI						
engine	c.c.	kw	hp	SRI part number	pcs	
1	AMF	1422	55	75	SRI031063KSK	2
2	ANY	1191	45	61	SRI031063KSK	2
3	ATL	1422	66	90	SRI031063KSK	2
4	BAG	1598	85	116	SRI031054KSK	4
5	BHC	1422	55	75	SRI031063KSK	2
6	BLF	1598	85	116	SRI031054KSK	4
7	BLP	1598	85	116	SRI031054KSK	4
8	CAVG	1390	136	185	SRI031054KSK	4
					SRI031054KSK	4
					SRI033054KSK	6
9	CAXA	1390	90	122	SRI933054KSK	8
					SRI031054KSK	4
10	CAXC	1390	92	125	SRI031054KSK	4
					SRI033054KSK	6
					SRI933054KSK	8
11	CBZA	1197	63	86	SRI030057KSK	6
					SRI031057KSK	4
					SRI032057KSK	7
12	CBZB	1197	77	105	SRI030057KSK	6
					SRI032057KSK	7
13	CMSA	1390	92	125	SRI031054KSK	4
14	CNVA	1390	90	122	SRI031054KSK	4
					SRI033054KSK	6
					SRI933054KSK	8
15	CTHG	1390	136	185	SRI031054KSK	4
16	CTJA	1390	136	185	SRI031054KSK	4

**KIT TENDICATENA PER MOTORE**

**TIMING CHAIN KIT PER ENGINE**

BMW						
					pcs	
engine	c.c.	kw	hp	SRI part number		
1	B37C15A	1496	70 85	95 116	SRI032043KSK	4
2	B37D15A	1496	70 85	95 116	SRI032043KSK	4
3	B57D30A	2993	183 195	249 265	SRI032043KSK	4
4	B57D30B	2993	235	320	SRI032043KSK	4
5	M41D17174T1	1665	66	90	SRI031076KSK	7
6	M41D18	1665	66	90	SRI031076KSK	7
7	M43B16164E2	1596	75	102	SRI030061KSK	4
8	M43B16164E3	1596	77	105	SRI030061KSK	4
9	M43B18184E2	1796	83 85	113 116	SRI030061KSK	4
10	M43B19194E1	1895	77 87	105 118	SRI030061KSK	4
11	M47D20204D4	1995	85 130	116 177	SRI030042KSK	7
					SRI031042KSK	4
					SRI032042KSK	4
12	M47N204D4	1995	90 115	122 156	SRI030042KSK	7
					SRI031042KSK	4
					SRI032042KSK	4
13	M51D25256T1	2497	85 105	116 143	SRI031076KSK	7
14	M57306D3	2993	145 173	197 235	SRI030042KSK	7
					SRI031042KSK	4
					SRI032042KSK	4
15	M57D25256D2	2497	130	177	SRI030042KSK	7
					SRI031042KSK	4
					SRI032042KSK	4
16	M57D30306D2	2993	150 160	204 218	SRI030042KSK	7
					SRI031042KSK	4
					SRI032042KSK	4
17	M57D30306D3	2993	145 180	197 245	SRI030042KSK	7
					SRI031042KSK	4
					SRI032042KSK	4
18	M57D30306D4	2993	200	272	SRI030042KSK	7
					SRI031042KSK	4
					SRI032042KSK	4
19	M57D30306D5	2993	210	286	SRI030042KSK	7
					SRI031042KSK	4
					SRI032042KSK	4
20	M57N2306D2	2993	160	218	SRI030042KSK	7
					SRI031042KSK	4
					SRI032042KSK	4

BMW						
					pcs	
engine	c.c.	kw	hp	SRI part number		
21	M57N2306D3	2993	150 180	204 245	SRI030042KSK	7
					SRI031042KSK	4
					SRI032042KSK	4
22	M57N306D2	2993	150 155	204 211	SRI030042KSK	7
					SRI031042KSK	4
					SRI032042KSK	4
23	M57N306D5	2993	210	286	SRI030042KSK	7
					SRI031042KSK	4
					SRI032042KSK	4
24	N40B16A	1596	77 85	105 116	SRI030064KSK	5
					SRI031064KSK	4
25	N42B18A	1796	85	116	SRI030062KSK	5
					SRI031062KSK	4
26	N42B20A	1995	100 105	136 143	SRI030062KSK	5
					SRI031062KSK	4
27	N45B16A	1596	85 90	116 122	SRI030064KSK	5
					SRI031064KSK	4
28	N46B18A	1796	85	116	SRI030062KSK	5
					SRI031062KSK	4
29	N46B20A	1995	100 110	136 150	SRI030062KSK	5
					SRI031062KSK	4
30	N46B20B	1995	95 125	129 170	SRI030062KSK	5
					SRI031062KSK	4
31	N46B20BD	1995	110 125	150 170	SRI030062KSK	5
					SRI031062KSK	4
32	N46B20C	1995	110 125	150 170	SRI030062KSK	5
					SRI031062KSK	4
33	N46B20CC	1995	110 125	150 170	SRI030062KSK	5
					SRI031062KSK	4
34	N46B20CD	1995	110 125	150 170	SRI030062KSK	5
					SRI031062KSK	4
35	N46B20E	1995	100 115	136 156	SRI030062KSK	5
					SRI031062KSK	4
36	N46NB20B	1995	110	150	SRI031062KSK	4
37	N47D16A	1598	70 85	95 116	SRI030043KSK	10
					SRI031043KSK	6
					SRI032043KSK	4
38	N47D20A	1995	100 120	136 197	SRI033043KSK	4
					SRI030043KSK	10
					SRI031043KSK	6
					SRI032043KSK	4

**KIT TENDICATENA PER MOTORE**

**TIMING CHAIN KIT PER ENGINE**

<b>BMW</b>						
engine	c.c.	kw	hp	SRI part number	pcs	
39	N47D20B	1995	150	204	SRI030043KSK	10
					SRI031043KSK	6
					SRI032043KSK	4
					SRI033043KSK	4
40	N47D20C	1995	100 150	136 204	SRI030043KSK	10
					SRI031043KSK	6
					SRI032043KSK	4
					SRI033043KSK	4
41	N47D20D	1995	150 160	204 218	SRI030043KSK	10
					SRI031043KSK	6
					SRI032043KSK	4
					SRI033043KSK	4
42	N57D30A	2993	150 225	204 306	SRI032043KSK	4
43	N57D30B	2993	220 230	299 313	SRI032043KSK	4
44	N57D30C	2993	280	381	SRI032043KSK	4

<b>CHEVROLET</b>						
engine	c.c.	kw	hp	SRI part number	pcs	
1	A12XEL	1229	51	69	SRI031070KSK	5
2	A12XER	1229	63	86	SRI031070KSK	5
3	A13DTCLDV	1248	55	75	SRI000030KSK	15
					SRI030075KSK	8
					SRI030100KSK	9
					SRI031000KSK	25
					SRI03100PKSK	16
					SRI032000KSK	6
					SRI033000KSK	4
					SRI034000KSK	9
4	A13DTELSF	1248	70	95	SRI000030KSK	15
					SRI030075KSK	8
					SRI030100KSK	9
					SRI031000KSK	25
					SRI03100PKSK	16
					SRI032000KSK	6
					SRI033000KSK	4
					SRI034000KSK	9
5	A14NELLUJ	1364	103	140	SRI031070KSK	5
6	A14NET	1364	103	140	SRI031070KSK	5
7	A14NETLUV	1364	103	140	SRI031070KSK	5
8	A14XER	1398	74	101	SRI031070KSK	5
9	A24XE	2384	123	167	SRI032058KSK	7
10	A24XF	2384	123	167	SRI032058KSK	7
11	B14NET	1364	103	140	SRI031070KSK	5
12	LDD	1398	74	101	SRI031070KSK	5

<b>CHEVROLET</b>						
engine	c.c.	kw	hp	SRI part number	pcs	
13	LE5	2384	123	167	SRI032058KSK	7
					SRI032058KSK	7
14	LE9	2384	123 125	167 170	SRI032058KSK	7
					SRI032058KSK	7
15	LUU	1398	111	151	SRI031070KSK	5

<b>CITROËN</b>						
engine	c.c.	kw	hp	SRI part number	pcs	
1	1KRFE	998	50	68	SRI030017KSK	7
					SRI031017KSK	4
					SRI930017KSK	8
					SRI031017KSK	4
2	4HGP22DTE	2198	81	110	SRI030067KSK	6
					SRI031067KSK	9
3	4HHP22DTE	2198	96	131	SRI030067KSK	6
					SRI031067KSK	9
4	4HJP22DTE	2198	110	150	SRI030067KSK	6
					SRI031067KSK	9
5	4HUP22DTE	2198	88	120	SRI030067KSK	6
					SRI031067KSK	9
6	4HVP22DTE	2198	74	101	SRI030067KSK	6
					SRI031067KSK	9
7	4HWDW12TED4	2179	94	128	SRI030059KSK	3
8	5F01EP6C	1598	88	120	SRI030074KSK	6
					SRI031074KSK	5
9	5F04EP6CDT	1598	115	156	SRI030046KSK	7
					SRI031046KSK	5
					SRI931046KSK	9
10	5FDEP6DTS	1598	152	207	SRI030046KSK	7
					SRI031046KSK	5
					SRI931046KSK	9
11	5FEEP6CDTMD	1598	110	150	SRI030046KSK	7
					SRI031046KSK	5
					SRI931046KSK	9
12	5FKEP6CB	1598	72	98	SRI030074KSK	6
					SRI031074KSK	5
13	5FMEP6CDTM	1598	120	163	SRI030046KSK	7
					SRI031046KSK	5
					SRI931046KSK	9
14	5FMEP6DT	1598	120	163	SRI030046KSK	7
					SRI031046KSK	5
					SRI931046KSK	9
15	5FNEP6CDT	1598	110 115	150 156	SRI030046KSK	7
					SRI031046KSK	5
					SRI931046KSK	9

**KIT TENDICATENA PER MOTORE**

**TIMING CHAIN KIT PER ENGINE**

CITROËN						
engine	c.c.	kw	hp	SRI part number	pcs	
16	5FNEP6DT	1598	110	150	SRI030046KSK	7
					SRI031046KSK	5
					SRI931046KSK	9
17	5FPEP6	1598	84	114	SRI030074KSK	6
					SRI031074KSK	5
18	5FREP6DT	1598	115	156	SRI030046KSK	7
					SRI031046KSK	5
					SRI931046KSK	9
19	5FSEP6C	1598	88	120	SRI030074KSK	6
					SRI031074KSK	5
20	5FSEP6DTS	1598	149	203	SRI030046KSK	7
					SRI031046KSK	5
					SRI931046KSK	9
21	5FTEP6DT	1598	103	140	SRI030046KSK	7
					SRI031046KSK	5
					SRI931046KSK	9
22	5FUEP6CDTX	1598	147	200	SRI030074KSK	6
					SRI031074KSK	5
23	5FVEP6CDT	1598	115	156	SRI030046KSK	7
					SRI031046KSK	5
					SRI931046KSK	9
24	5FWEP6	1598	88	120	SRI030074KSK	6
					SRI031074KSK	5
25	5FXEP6DT	1598	110 115	150 156	SRI030046KSK	7
					SRI031046KSK	5
					SRI931046KSK	9
26	5GMEP6FDTX	1598	155	211	SRI030074KSK	6
					SRI031074KSK	5
27	5GTEP6FDTX	1598	151	205	SRI030074KSK	6
					SRI031074KSK	5
28	5GYEP6FDTM	1598	120 121	163 165	SRI030046KSK	7
					SRI031046KSK	5
					SRI931046KSK	9
29	5GZEP6FDT	1598	115 121	156 165	SRI030046KSK	7
					SRI031046KSK	5
					SRI931046KSK	9
30	8F01EP3C	1397	70 72	95 98	SRI030074KSK	6
					SRI031074KSK	5
					SRI030074KSK	6
31	8FN3P3	1397	70	95	SRI031074KSK	5
					SRI030074KSK	6
32	8FN3P3CG	1397	70	95	SRI030074KSK	6
					SRI031074KSK	5
33	8FPEP3	1397	70	95	SRI030074KSK	6
					SRI031074KSK	5

CITROËN						
engine	c.c.	kw	hp	SRI part number	pcs	
34	8FPEP3C	1397	70	95	SRI030074KSK	6
					SRI031074KSK	5
35	8FREP3	1397	72	98	SRI030074KSK	6
					SRI031074KSK	5
36	8FSEP3	1397	70	95	SRI030074KSK	6
					SRI031074KSK	5
37	8HYDV4TED4	1398	66	90	SRI030047KSK	2
38	9H01DV6TED4	1560	80	109	SRI030047KSK	2
39	9H03DV6AUTED4	1560	66	90	SRI030047KSK	2
40	9HSDV6TED4BU	1560	66	90	SRI030047KSK	2
41	9HTDV6BUTED4	1560	55	75	SRI030047KSK	2
42	9HUDV6UTED4	1560	66	90	SRI030047KSK	2
43	9HVDV6TED4	1560	80	109	SRI030047KSK	2
44	9HXDV6ATED4	1560	66 68	90 92	SRI030047KSK	2
45	9HYDV6TED4	1560	80 85	109 116	SRI030047KSK	2
46	9HZDV6TED4	1560	80	109	SRI030047KSK	2
47	AHYDW10CE	1997	72	98	SRI030059KSK	3
48	AHZDW10CD	1997	94	128	SRI030059KSK	3
49	DV6ATED4	1560	66	90	SRI030047KSK	2
50	DV6B	1560	55	75	SRI030047KSK	2
51	F1CE0481DF30DT	2999	115 130	156 177	SRI031023KSK	19
					SRI032023KSK	9
					SRI033023KSK	6
					SRI034023KSK	8
					SRI035023KSK	6
52	F1CE3481EF30DTE	2999	130	177	SRI036023KSK	5
					SRI031023KSK	19
					SRI032023KSK	9
					SRI033023KSK	6
					SRI034023KSK	8
53	FHYP13DTE6	1248	59	80	SRI035023KSK	6
					SRI036023KSK	5
					SRI000030KSK	15
					SRI030075KSK	8
					SRI030100KSK	9
					SRI031000KSK	25
					SRI031001KSK	26
					SRI03100PKSK	16
					SRI032000KSK	6
					SRI033000KSK	4
SRI034000KSK	9					

**KIT TENDICATENA PER MOTORE**





**TIMING CHAIN KIT PER ENGINE**





<b>CITROËN</b>						
engine	c.c.	kw	hp	SRI part number	pcs	
54	FHZF13DTE5	1248	55	75	SRI000030KSK	15
					SRI030075KSK	8
					SRI030100KSK	9
					SRI031000KSK	25
					SRI031001KSK	26
					SRI03100PKSK	16
					SRI032000KSK	6
					SRI033000KSK	4
					SRI034000KSK	9
55	RH01DW10BTED4	1997	100 103	136 140	SRI030059KSK	3
56	RH02DW10CTED4	1997	120	163	SRI030059KSK	3
57	RHCDW10CTED4	1997	120	163	SRI030059KSK	3
58	RHDDW10CB	1997	100	136	SRI030059KSK	3
59	RHDDW10CTED4	1997	100	136	SRI030059KSK	3
60	RHEDW10CTED4	1997	100- 120	136- 163	SRI030059KSK	3
61	RHFDW10BTED4	1997	100 103	136 140	SRI030059KSK	3
62	RHGDW10UTED4	1997	88	120	SRI030059KSK	3
63	RHHDW10CTED4	1997	120	163	SRI030059KSK	3
64	RHJDW10BTED4	1997	100	136	SRI030059KSK	3
65	RHKDW10UTED4	1997	88	120	SRI030059KSK	3
66	RHLDW10BTED4	1997	93	126	SRI030059KSK	3
67	RHRDW10BTED4	1997	100	136	SRI030059KSK	3
<b>DAIHATSU</b>						
engine	c.c.	kw	hp	SRI part number	pcs	
1	1KRFE	998	51	69	SRI030017KSK	7
					SRI031017KSK	4
					SRI930017KSK	8

<b>FIAT</b>						
engine	c.c.	kw	hp	SRI part number	pcs	
1	100	633	15,8	21,5	SRI039008KSK	5
2	100D000	843	25	34	SRI039009KSK	5
3	100GL	903	25,8	35	SRI039009KSK	5
			34,5	47	SRI039005KSK	5
4	110000	479	10	13,5	SRI039006KSK	5
					SRI039001KSK	5
5	115A000	1295	44,1	60	SRI039007KSK	5
		1481	52,9	72	SRI039007KSK	5
6	125A000	1608	74,4	101,2	SRI039007KSK	5
7	126A000	594	17	23	SRI039001KSK	5
					SRI039002KSK	5
8	126A1000	652	17	23	SRI039001KSK	5
9	126A1048	652	17 18	23 24	SRI039001KSK	5
10	126A2000	704	19	26	SRI039001KSK	5
11	126A2048	704	19	26	SRI039001KSK	5
12	141A000	652	22	30	SRI039005KSK	5
					SRI039006KSK	5
					SRI039003KSK	5
					SRI039004KSK	5
13	169A1000	1248	55	75	SRI000030KSK	15
					SRI030100KSK	9
					SRI031000KSK	25
					SRI031001KSK	26
					SRI03100PKSK	16
					SRI032000KSK	6
					SRI033000KSK	4
					SRI034000KSK	9
					SRI039005KSK	5
14	169A5000	1248	55	75	SRI000030KSK	15
					SRI030100KSK	9
					SRI031000KSK	25
					SRI031001KSK	26
					SRI03100PKSK	16
					SRI032000KSK	6
SRI033000KSK	4					
SRI034000KSK	9					

**KIT TENDICATENA PER MOTORE**

**TIMING CHAIN KIT PER ENGINE**





FIAT						
						
engine	c.c.	kw	hp	SRI part number	pcs	
15	188A8000	1248	51	69	SRI000030KSK	15
					SRI030100KSK	9
					SRI031000KSK	25
					SRI031001KSK	26
					SRI03100PKSK	16
					SRI032000KSK	6
					SRI033000KSK	4
					SRI034000KSK	9
16	188A9000	1248	50 52	68 71	SRI000030KSK	15
					SRI030100KSK	9
					SRI031000KSK	25
					SRI031001KSK	26
					SRI03100PKSK	16
					SRI032000KSK	6
					SRI033000KSK	4
					SRI034000KSK	9
17	194A1000	2198	108	147	SRI030045KSK	17
					SRI030058KSK	17
					SRI030065KSK	16
					SRI031045KSK	5
					SRI031058KSK	6
					SRI031065KSK	13
					SRI032065KSK	14
18	199A2000	1248	55 56	75 76	SRI000030KSK	15
					SRI030075KSK	8
					SRI030100KSK	9
					SRI031000KSK	25
					SRI031001KSK	26
					SRI03100PKSK	16
					SRI032000KSK	6
					SRI033000KSK	4
					SRI034000KSK	9
19	199A3000	1248	66 68	90 92	SRI000030KSK	15
					SRI030075KSK	8
					SRI030100KSK	9
					SRI031000KSK	25
					SRI031001KSK	26
					SRI03100PKSK	16
					SRI032000KSK	6
					SRI033000KSK	4
					SRI034000KSK	9





FIAT						
						
engine	c.c.	kw	hp	SRI part number	pcs	
20	199A9000	1248	55 56	75 76	SRI000030KSK	15
					SRI030075KSK	8
					SRI030100KSK	9
					SRI031000KSK	25
					SRI031001KSK	26
					SRI03100PKSK	16
					SRI032000KSK	6
					SRI033000KSK	4
					SRI034000KSK	9
21	199B1000	1248	70	95	SRI000030KSK	15
					SRI030075KSK	8
					SRI030100KSK	9
					SRI031000KSK	25
					SRI031001KSK	26
					SRI03100PKSK	16
					SRI032000KSK	6
					SRI033000KSK	4
					SRI034000KSK	9
22	199B2000	1248	51	69	SRI000030KSK	15
					SRI030100KSK	9
					SRI031000KSK	25
					SRI031001KSK	26
					SRI03100PKSK	16
					SRI032000KSK	6
					SRI033000KSK	4
					SRI034000KSK	9
					23	199B4000
SRI030075KSK	8					
SRI030100KSK	9					
SRI031000KSK	25					
SRI031001KSK	26					
SRI03100PKSK	16					
SRI032000KSK	6					
SRI033000KSK	4					
SRI034000KSK	9					
24	199B6000	875	77	105	SRI030055KSK	6
					SRI031055KSK	4
25	199B8000	1248	59	80	SRI000030KSK	15
					SRI030100KSK	9
					SRI031000KSK	25
					SRI031001KSK	26
					SRI03100PKSK	16
					SRI032000KSK	6
					SRI033000KSK	4
					SRI034000KSK	9



**KIT TENDICATENA PER MOTORE**





**TIMING CHAIN KIT PER ENGINE**





FIAT						
					pcs	
engine	c.c.	kw	hp	SRI part number		
26	223A9000	1248	62	84	SRI000030KSK	15
					SRI030100KSK	9
					SRI031000KSK	25
					SRI031001KSK	26
					SRI03100PKSK	16
					SRI032000KSK	6
					SRI033000KSK	4
					SRI034000KSK	9
27	225A2000	1248	59	80	SRI000030KSK	15
					SRI030075KSK	8
					SRI030100KSK	9
					SRI031000KSK	25
					SRI031001KSK	26
					SRI03100PKSK	16
					SRI032000KSK	6
					SRI033000KSK	4
28	263A2000	1248	66	90	SRI000030KSK	15
					SRI030075KSK	8
					SRI030100KSK	9
					SRI031000KSK	25
					SRI031001KSK	26
					SRI03100PKSK	16
					SRI032000KSK	6
					SRI033000KSK	4
29	263A6000	1248	55	75	SRI000030KSK	15
					SRI030075KSK	8
					SRI030100KSK	9
					SRI031000KSK	25
					SRI031001KSK	26
					SRI03100PKSK	16
					SRI032000KSK	6
					SRI033000KSK	4
30	312A2000	875	57 63	78 86	SRI030055KSK	6
					SRI031055KSK	4
31	312A4000	964	44 48	60 65	SRI030055KSK	6
					SRI031055KSK	4
32	312A5000	875	59 63	80 86	SRI030055KSK	6
					SRI031055KSK	4

FIAT						
					pcs	
engine	c.c.	kw	hp	SRI part number		
33	312A6000	964	44 48	60 65	SRI030055KSK	6
					SRI031055KSK	4
34	312A7000	875	57 66	78 90	SRI030055KSK	6
					SRI031055KSK	4
35	312A8000	1248	59	80	SRI000030KSK	15
					SRI030075KSK	8
					SRI030100KSK	9
					SRI031000KSK	25
					SRI031001KSK	26
					SRI03100PKSK	16
					SRI032000KSK	6
					SRI033000KSK	4
36	312B1000	1248	70	95	SRI000030KSK	15
					SRI030100KSK	9
					SRI031000KSK	25
					SRI031001KSK	26
					SRI03100PKSK	16
					SRI032000KSK	6
					SRI033000KSK	4
					SRI034000KSK	9
37	312B2000	1248	59	80	SRI000030KSK	15
					SRI030075KSK	8
					SRI030100KSK	9
					SRI031000KSK	25
					SRI031001KSK	26
					SRI03100PKSK	16
					SRI032000KSK	6
					SRI033000KSK	4
38	312B5000	1248	57	78	SRI030075KSK	8
					SRI030100KSK	9
39	330A1000	1248	70	95	SRI000030KSK	15
					SRI030075KSK	8
					SRI030100KSK	9
					SRI031000KSK	25
					SRI031001KSK	26
					SRI03100PKSK	16
					SRI032000KSK	6
					SRI033000KSK	4
SRI034000KSK	9					

**KIT TENDICATENA PER MOTORE**







**TIMING CHAIN KIT PER ENGINE**







FIAT						
						
engine	c.c.	kw	hp	SRI part number	pcs	
40	4HV	2198	74	101	SRI030067KSK	6
					SRI031067KSK	9
41	4HWDW12ATED4	2179	94	128	SRI030059KSK	3
42	55266963	1248	70	95	SRI000030KSK	15
					SRI030075KSK	8
					SRI030100KSK	9
					SRI031000KSK	25
					SRI031001KSK	26
					SRI03100PKSK	16
					SRI032000KSK	6
					SRI033000KSK	4
					SRI034000KSK	9
					SRI033000KSK	4
43	955B2000	1248	66	90	SRI000030KSK	15
					SRI030075KSK	8
					SRI030100KSK	9
					SRI031000KSK	25
					SRI031001KSK	26
					SRI03100PKSK	16
					SRI032000KSK	6
					SRI033000KSK	4
					SRI034000KSK	9
					SRI033000KSK	4
44	9H07DV6UC	1560	66	90	SRI030047KSK	2
45	9HM	1560	66	90	SRI030047KSK	2
46	9HU	1560	66	90	SRI030047KSK	2
47	DV6UC9HM	1560	66	90	SRI030047KSK	2
48	DV6UTED4	1560	66	90	SRI030047KSK	2
49	DW10BTED4	1997	100	136	SRI030059KSK	3
50	DW10UTED4	1997	88	120	SRI030059KSK	3
51	F1CE0441A	2998	100	136	SRI032023KSK	9
					SRI033023KSK	6
					SRI034023KSK	8
					SRI035023KSK	6
					SRI036023KSK	5
52	F1CE0481D	2999	115 116	156 158	SRI030077KSK	19
					SRI031077KSK	8
					SRI032077KSK	3
					SRI033077KSK	5

FIAT						
						
engine	c.c.	kw	hp	SRI part number	pcs	
53	F1CE3481E	2999	130	177	SRI030077KSK	19
					SRI031077KSK	8
					SRI032077KSK	3
					SRI033077KSK	5
54	F1CE3481M	2999	115 116	156 158	SRI030077KSK	19
					SRI031077KSK	8
					SRI032077KSK	3
					SRI033077KSK	5
55	F1CE3481N	2999	107	146	SRI030077KSK	19
					SRI031023KSK	19
					SRI031077KSK	8
					SRI032023KSK	9
					SRI032077KSK	3
					SRI033023KSK	6
					SRI033077KSK	5
					SRI034023KSK	8
					SRI035023KSK	6
					SRI036023KSK	5
SRI032023KSK	9					
56	F1CFA401A	2998	100	136	SRI033023KSK	6
					SRI034023KSK	8
					SRI035023KSK	6
					SRI036023KSK	5
					SRI030025KSK	6
57	M16A	1586	79 88	107 120	SRI031025KSK	4
58	RH02	1997	94 120	128 163	SRI030059KSK	3
58	RHG	1997	88	120	SRI030059KSK	3
59	RHH	1997	120	163	SRI030059KSK	3
60	RHK	1997	88	120	SRI030059KSK	3
61	RHMDW10ATED4	1997	79	107	SRI030059KSK	3
62	RHR	1997	100	136	SRI030059KSK	3
63	RHT	1997	79	107	SRI030059KSK	3
64	RHWDW10ATED4	1997	80	109	SRI030059KSK	3

**KIT TENDICATENA PER MOTORE**

**TIMING CHAIN KIT PER ENGINE**

FORD						
						
	engine	c.c.	kw	hp	SRI part number	pcs
1	A9A	1299	51	69	SRI030052KSK	6
					SRI031052KSK	4
2	A9B	1299	51	69	SRI030052KSK	6
					SRI031052KSK	4
3	A9JA	1299	51	69	SRI030052KSK	6
					SRI031052KSK	4
4	A9JB	1299	51	69	SRI030052KSK	6
					SRI031052KSK	4
5	ABFA	1998	74	101	SRI034066KSK	7
					SRI035066KSK	7
6	AOBA	1999	107	146	SRI031083KSK	3
7	AOBC	1999	107	146	SRI031083KSK	3
8	AODA	1999	107	146	SRI031083KSK	3
9	AODB	1999	107	146	SRI031083KSK	3
10	AODE	1999	107	146	SRI031083KSK	3
11	AOJB	1999	105	143	SRI031083KSK	3
12	AOWA	1999	107	146	SRI031083KSK	3
13	AOWB	1999	107	146	SRI031083KSK	3
14	AZBA	1997	96	131	SRI030059KSK	3
15	AZBC	1997	100	136	SRI030059KSK	3
16	AZWA	1997	96	131	SRI030059KSK	3
17	AZWC	1997	100	136	SRI030059KSK	3
18	BAJA	1299	44	60	SRI030052KSK	6
					SRI031052KSK	4
19	BHDA	1753	55	75	SRI030049KSK	5
					SRI031049KSK	8
20	BHDB	1753	55	75	SRI030049KSK	5
					SRI031049KSK	8
21	BHPA	1753	55	75	SRI030049KSK	5
					SRI031049KSK	8
22	C9DA	1753	66	90	SRI030049KSK	5
					SRI031049KSK	8
23	C9DB	1753	66	90	SRI030049KSK	5
					SRI031049KSK	8
24	C9DC	1753	66	90	SRI030049KSK	5
					SRI031049KSK	8
25	C9DE	1753	66	90	SRI030049KSK	5
					SRI031049KSK	8

FORD						
						
	engine	c.c.	kw	hp	SRI part number	pcs
26	CDB	1598	70	95	SRI030052KSK	6
					SRI031052KSK	4
27	CDC	1598	70	95	SRI030052KSK	6
					SRI031052KSK	4
28	CDRB	1599	70	95	SRI030052KSK	6
					SRI031052KSK	4
29	CJBA	1999	107	146	SRI031083KSK	3
30	CJBB	1999	107	146	SRI031083KSK	3
31	CSDA	1798	88	120	SRI031083KSK	3
32	CSDB	1798	88	120	SRI031083KSK	3
33	CV24	2198	114	155	SRI033068KSK	7
					SRI036068KSK	18
34	CVF5	2198	114	155	SRI030067KSK	6
					SRI031067KSK	9
35	CVFF	2198	114	155	SRI030067KSK	6
					SRI031067KSK	9
					SRI033068KSK	7
36	CVR5	2198	114	155	SRI033068KSK	7
					SRI036068KSK	18
37	CVRA	2198	114	155	SRI033068KSK	7
					SRI036068KSK	18
38	CVRB	2198	114	155	SRI033068KSK	7
					SRI036068KSK	18
39	CVRC	2198	114	155	SRI033068KSK	7
					SRI036068KSK	18
40	CY14	2198	92	125	SRI030067KSK	6
					SRI031067KSK	9
41	CY24	2198	92	125	SRI033068KSK	7
					SRI036068KSK	18
42	CYF4	2198	92	125	SRI030067KSK	6
					SRI031067KSK	9
43	CYF5	2198	92	125	SRI030067KSK	6
					SRI031067KSK	9
44	CYFA	2198	92	125	SRI030067KSK	6
					SRI031067KSK	9
45	CYFB	2198	92	125	SRI030067KSK	6
					SRI031067KSK	9

**KIT TENDICATENA PER MOTORE**





**TIMING CHAIN KIT PER ENGINE**





FORD						
engine	c.c.	kw	hp	SRI part number	pcs	
46	CYFC	2198	92	125	SRI030067KSK	6
					SRI031067KSK	9
47	CYFD	2198	92	125	SRI030067KSK	6
					SRI031067KSK	9
48	CYFF	2198	92	125	SRI030067KSK	6
					SRI031067KSK	9
					SRI033068KSK	7
					SRI036068KSK	18
48	CYFG	2198	92	125	SRI030067KSK	6
					SRI031067KSK	9
49	CYR5	2198	92	125	SRI033068KSK	7
					SRI036068KSK	18
50	CYRA	2198	92	125	SRI033068KSK	7
					SRI036068KSK	18
51	CYRB	2198	92	125	SRI033068KSK	7
					SRI036068KSK	18
52	CYRC	2198	92	125	SRI033068KSK	7
					SRI036068KSK	18
53	D2FA	2402	66	90	SRI030066KSK	7
					SRI031066KSK	9
					SRI032066KSK	7
54	D2FB	2402	66	90	SRI030066KSK	7
					SRI031066KSK	9
					SRI032066KSK	7
55	D2FE	2402	66	90	SRI030066KSK	7
					SRI031066KSK	9
					SRI032066KSK	7
56	D3FA	1998	55	75	SRI034066KSK	7
					SRI035066KSK	7
57	D4FA	2402	88	120	SRI030069KSK	7
					SRI032069KSK	7
					SRI033069KSK	7
58	D5BA	1998	66	90	SRI030066KSK	7
					SRI031066KSK	9
					SRI032066KSK	7
59	D6BA	1998	85	116	SRI032066KSK	7
60	DOFA	2402	92	125	SRI030069KSK	7
					SRI032069KSK	7
					SRI033069KSK	7
					SRI033069KSK	7

FORD						
engine	c.c.	kw	hp	SRI part number	pcs	
61	DRF4	2198	74	101	SRI030067KSK	6
					SRI031067KSK	9
62	DRF5	2198	74	101	SRI030067KSK	6
					SRI031067KSK	9
63	DRFA	2198	74	101	SRI030067KSK	6
					SRI031067KSK	9
64	DRFB	2198	74	101	SRI030067KSK	6
					SRI031067KSK	9
65	DRFC	2198	74	101	SRI030067KSK	6
					SRI031067KSK	9
66	DRFD	2198	74	101	SRI030067KSK	6
					SRI031067KSK	9
67	DRFE	2198	74	101	SRI030067KSK	6
					SRI031067KSK	9
68	DRFF	2198	74	101	SRI030067KSK	6
					SRI031067KSK	9
69	DRFG	2198	74	101	SRI030067KSK	6
					SRI031067KSK	9
70	DRR5	2198	74	101	SRI033068KSK	7
					SRI036068KSK	18
71	DRRA	2198	74	101	SRI033068KSK	7
					SRI036068KSK	18
					SRI036068KSK	18
72	DRRB	2198	74	101	SRI033068KSK	7
					SRI036068KSK	18
73	DRRC	2198	74	101	SRI033068KSK	7
					SRI036068KSK	18
74	F3FA	1998	63	86	SRI034066KSK	7
					SRI035066KSK	7
75	F4FA	2402	55	75	SRI030066KSK	7
					SRI031066KSK	9
76	F9DA	1753	85	116	SRI030049KSK	5
					SRI031049KSK	8
77	F9DB	1753	85	116	SRI030049KSK	5
					SRI031049KSK	8

**KIT TENDICATENA PER MOTORE**





**TIMING CHAIN KIT PER ENGINE**





FORD						
					pcs	
engine	c.c.	kw	hp	SRI part number		
78	FD4	1248	55	75	SRI000030KSK	15
					SRI030075KSK	8
					SRI030100KSK	9
					SRI031000KSK	25
					SRI031001KSK	26
					SRI03100PKSK	16
					SRI032000KSK	6
					SRI033000KSK	4
					SRI034000KSK	9
					79	FFBA
SRI031049KSK	8					
80	FFDA	1753	74	101	SRI030049KSK	5
					SRI031049KSK	8
81	FFWA	1753	74	101	SRI030049KSK	5
					SRI031049KSK	8
82	FIFA	1998	92	125	SRI034066KSK	7
					SRI035066KSK	7
83	FMBA	1998	96	131	SRI030066KSK	7
					SRI031066KSK	9
					SRI032066KSK	7
					SRI034066KSK	7
					SRI035066KSK	7
84	FMBB	1998	96	131	SRI030066KSK	7
					SRI031066KSK	9
					SRI032066KSK	7
					SRI034066KSK	7
					SRI035066KSK	7
85	FXFA	2402	85	116	SRI033069KSK	7
86	G6DA	1997	100	136	SRI030059KSK	3
87	G6DB	1997	100	136	SRI030059KSK	3
88	G6DC	1997	100	136	SRI030059KSK	3
			98	133	SRI030059KSK	3
89	G6DD	1997	100	136	SRI030059KSK	3
90	G6DE	1997	98	133	SRI030059KSK	3
91	G6DF	1997	98	133	SRI030059KSK	3
92	G6DG	1997	100	136	SRI030059KSK	3
93	G8DA	1560	80	109	SRI030047KSK	2
94	G8DB	1560	80	109	SRI030047KSK	2
95	G8DC	1560	74	101	SRI030047KSK	2
96	G8DD	1560	80	109	SRI030047KSK	2
97	G8DE	1560	80	109	SRI030047KSK	2
98	G8DF	1560	80	109	SRI030047KSK	2

FORD						
					pcs	
engine	c.c.	kw	hp	SRI part number		
99	GBVAJPF	2198	88	120	SRI033068KSK	7
					SRI036068KSK	18
100	GBVAJQJ	2198	110	150	SRI033068KSK	7
					SRI036068KSK	18
101	GBVAJQW	2198	92	125	SRI033068KSK	7
			96	131	SRI036068KSK	18
102	GLA	1117	39	53	SRI039010KSK	6
103	GLW	1117	40	54	SRI039010KSK	6
104	GPDA	1560	66	90	SRI030047KSK	2
105	GPDB	1560	66	90	SRI030047KSK	2
106	GPDC	1560	66	90	SRI030047KSK	2
107	GZ	2261	110	150	SRI031083KSK	3
108	GZFA	2295	107	146	SRI031083KSK	3
109	GZFB	2295	107	146	SRI031083KSK	3
110	GZFC	2295	107	146	SRI031083KSK	3
111	H9FA	2402	101	137	SRI030068KSK	7
					SRI031068KSK	11
					SRI032068KSK	7
					SRI033069KSK	7
					SRI034068KSK	8
SRI035068KSK	18					
112	H9FB	2402	103	140	SRI030068KSK	7
					SRI031068KSK	11
					SRI032068KSK	7
					SRI034068KSK	8
					SRI035068KSK	18
113	H9FD	2402	103	140	SRI030068KSK	7
					SRI031068KSK	11
					SRI032068KSK	7
					SRI034068KSK	8
					SRI035068KSK	18
114	HCPA	1753	66	90	SRI030049KSK	5
					SRI031049KSK	8
115	HCPB	1753	66	90	SRI030049KSK	5
					SRI031049KSK	8
116	HFFA	2402	88	120	SRI030069KSK	7
					SRI032069KSK	7
117	HHDA	1560	66	90	SRI030047KSK	2
					SRI030047KSK	2
118	HHDB	1560	66	90	SRI030047KSK	2

**KIT TENDICATENA PER MOTORE**

**TIMING CHAIN KIT PER ENGINE**

FORD						
					pcs	
engine	c.c.	kw	hp	SRI part number		
119	HHJA	1560	66	90	SRI030047KSK	2
120	HHJB	1560	66	90	SRI030047KSK	2
121	HHJC	1560	66	90	SRI030047KSK	2
122	HHJD	1560	66	90	SRI030047KSK	2
123	HHJE	1560	66	90	SRI030047KSK	2
124	HHJF	1560	55	75	SRI030047KSK	2
125	HJBA	1998	85	116	SRI030066KSK	7
					SRI031066KSK	9
					SRI032066KSK	7
126	HJBB	1998	85	116	SRI030066KSK	7
					SRI031066KSK	9
					SRI032066KSK	7
127	HJBC	1998	85	116	SRI030066KSK	7
					SRI031066KSK	9
					SRI032066KSK	7
128	IXDA	1997	81	110	SRI030059KSK	3
129	JBB	1297	44	60	SRI039010KSK	6
130	JLA	1297	44	60	SRI039010KSK	6
131	JLB	1297	44	60	SRI039010KSK	6
132	JXFA	2402	85	116	SRI030068KSK	7
					SRI031068KSK	11
					SRI032068KSK	7
					SRI034068KSK	8
					SRI035068KSK	18
133	JXFC	2402	85	116	SRI030068KSK	7
					SRI031068KSK	11
					SRI032068KSK	7
					SRI034068KSK	8
					SRI035068KSK	18
134	KHBA	1753	92	125	SRI030049KSK	5
					SRI031049KSK	8
135	KKDA	1753	85	116	SRI030049KSK	5
					SRI031049KSK	8
136	KKDB	1753	85	116	SRI030049KSK	5
					SRI031049KSK	8
137	KLBA	1997	85	116	SRI030059KSK	3
138	KLWA	1997	85	116	SRI030059KSK	3
139	LPBA	1997	85	116	SRI030059KSK	3
140	MTDA	1560	74	101	SRI030047KSK	2

FORD						
					pcs	
engine	c.c.	kw	hp	SRI part number		
141	N7BA	1998	96	131	SRI030066KSK	7
					SRI031066KSK	9
					SRI032066KSK	7
					SRI034066KSK	7
					SRI035066KSK	7
142	P7PA	1753	55	75	SRI030049KSK	5
					SRI031049KSK	8
143	P7PB	1753	55	75	SRI030049KSK	5
					SRI031049KSK	8
144	P8FA	2198	63	86	SRI030067KSK	6
					SRI031067KSK	9
145	P8FB	2198	63	86	SRI030067KSK	6
					SRI031067KSK	9
146	P9PA	1753	66	90	SRI030049KSK	5
					SRI031049KSK	8
147	P9PB	1753	66	90	SRI030049KSK	5
					SRI031049KSK	8
148	P9PC	1753	66	90	SRI030049KSK	5
					SRI031049KSK	8
149	P9PD	1753	66	90	SRI030049KSK	5
					SRI031049KSK	8
150	PGFA	2198	103	140	SRI030067KSK	6
					SRI031067KSK	9
151	PGFB	2198	103	140	SRI030067KSK	6
					SRI031067KSK	9
152	PHFA	2402	74	101	SRI030068KSK	7
					SRI031068KSK	11
					SRI032068KSK	7
					SRI034068KSK	8
					SRI035068KSK	18
153	PHFC	2402	74	101	SRI030068KSK	7
					SRI031068KSK	11
					SRI032068KSK	7
					SRI034068KSK	8
					SRI035068KSK	18
154	Q2JSGBVAJQJ	2198	118	160	SRI033068KSK	7
155	Q7DA	1798	92	125	SRI031083KSK	3
156	QQDA	1798	92	125	SRI031083KSK	3
157	QQDB	1798	92	125	SRI031083KSK	3
158	QQDC	1798	90	122	SRI031083KSK	3

**KIT TENDICATENA PER MOTORE**

**TIMING CHAIN KIT PER ENGINE**

FORD						
engine	c.c.	kw	hp	SRI part number	pcs	
159	QVFA	2198	81	110	SRI030067KSK	6
					SRI031067KSK	9
160	QWFA	2198	96	131	SRI030067KSK	6
					SRI031067KSK	9
161	QXBA	1997	103	140	SRI030059KSK	3
162	QXBB	1997	103	140	SRI030059KSK	3
163	QXWA	1997	103	140	SRI030059KSK	3
164	QXWB	1997	103	140	SRI030059KSK	3
165	QXWC	1997	103	140	SRI030059KSK	3
166	QYBA	1753	92	125	SRI030049KSK	5
					SRI031049KSK	8
167	QYWA	1753	92	125	SRI030049KSK	5
					SRI031049KSK	8
168	R2PA	1753	55	75	SRI030049KSK	5
					SRI031049KSK	8
169	R3PA	1753	66	90	SRI030049KSK	5
					SRI031049KSK	8
170	RTN	1753	55	75	SRI030049KSK	5
					SRI031049KSK	8
171	RTP	1753	55	75	SRI030049KSK	5
					SRI031049KSK	8
172	RTQ	1753	55	75	SRI030049KSK	5
					SRI031049KSK	8
173	RWPA	1753	81	110	SRI030049KSK	5
					SRI031049KSK	8
174	RWPC	1753	81	110	SRI030049KSK	5
					SRI031049KSK	8
175	RWPD	1753	81	110	SRI030049KSK	5
					SRI031049KSK	8
176	RWPE	1753	66	90	SRI030049KSK	5
					SRI031049KSK	8
177	RWPF	1753	66	90	SRI030049KSK	5
					SRI031049KSK	8
178	SRFA	2198	85	116	SRI030067KSK	6
					SRI031067KSK	9
179	SRFB	2198	85	116	SRI030067KSK	6
					SRI031067KSK	9
180	SRFC	2198	85	116	SRI030067KSK	6
					SRI031067KSK	9

FORD						
engine	c.c.	kw	hp	SRI part number	pcs	
181	SRFD	2198	85	116	SRI030067KSK	6
					SRI031067KSK	9
182	SRFE	2198	85	116	SRI030067KSK	6
					SRI031067KSK	9
183	SYDA	1999	105 107	143 146	SRI031083KSK	3
184	T3JA	1560	70	95	SRI030047KSK	2
185	T7DA	1998	110	150	SRI030059KSK	3
186	T7DB	1998	110	150	SRI030059KSK	3
187	T8DA	1998	132	180	SRI030059KSK	3
188	TBBA	1999	107	146	SRI031083KSK	3
189	TKA	957	29	39	SRI039010KSK	6
190	TKW	957	29	39	SRI039010KSK	6
191	TLA	957	33	45	SRI039010KSK	6
192	TNBA	1999	149	203	SRI031083KSK	3
193	TNBB	1999	146	199	SRI031083KSK	3
194	TNWA	1999	149	203	SRI031083KSK	3
195	TNWB	1999	146	199	SRI031083KSK	3
196	TPBA	1999	176	239	SRI031083KSK	3
197	TPWA	1999	176	239	SRI031083KSK	3
198	TXBA	1997	120	163	SRI030059KSK	3
199	TXBB	1997	120	163	SRI030059KSK	3
200	TXDA	1997	120	163	SRI030059KSK	3
201	TXDB	1997	120	163	SRI030059KSK	3
202	TXWA	1997	120	163	SRI030059KSK	3
203	TYBA	1997	85	116	SRI030059KSK	3
204	TYDA	1997	85	116	SRI030059KSK	3
205	TYWA	1997	85	116	SRI030059KSK	3
206	TZJA	1560	70	95	SRI030047KSK	2
207	TZJB	1560	70	95	SRI030047KSK	2
208	UBJA	1560	55	75	SRI030047KSK	2
209	UFBA	1997	103	140	SRI030059KSK	3
210	UFBB	1997	103	140	SRI030059KSK	3
211	UFDA	1997	100 103	136 140	SRI030059KSK	3
212	UFDB	1997	103	140	SRI030059KSK	3
213	UFWA	1997	103	140	SRI030059KSK	3
214	UHFA	2198	103	140	SRI030067KSK	6
					SRI031067KSK	9
215	UHFB	2198	103	140	SRI030067KSK	6
					SRI031067KSK	9

**KIT TENDICATENA PER MOTORE**

**TIMING CHAIN KIT PER ENGINE**

<b>FORD</b>						
engine	c.c.	kw	hp	SRI part number	pcs	
216	UHFC	2198	103	140	SRI030067KSK	6
					SRI031067KSK	9
217	UHR5	2198	99	135	SRI033068KSK	7
					SRI036068KSK	18
218	UKBA	1997	100	136	SRI030059KSK	3
219	UKBB	1997	100	136	SRI030059KSK	3
220	UKDA	1997	100	136	SRI030059KSK	3
221	UKDB	1997	100	136	SRI030059KSK	3
222	UKWA	1997	100	136	SRI030059KSK	3
223	USR6	2198	92	125	SRI033068KSK	7
					SRI036068KSK	18
224	USRA	2198	100	136	SRI033068KSK	7
					SRI036068KSK	18
225	USRB	2198	100	136	SRI033068KSK	7
					SRI036068KSK	18
226	UYR6	2198	114	155	SRI033068KSK	7
					SRI036068KSK	18





<b>HYUNDAI</b>						
engine	c.c.	kw	hp	SRI part number	pcs	
5	D4FA	1493	65 81	88 110	SRI030071KSK	13
					SRI031071KSK	9
					SRI032071KSK	7
					SRI033071KSK	5
					SRI034071KSK	5
					SRI035071KSK	4
6	D4FB	1582	100 66	136 90	SRI035071KSK	4
					SRI030071KSK	13
					SRI031071KSK	9
					SRI032071KSK	7
6	D4FB	1582	66 94	90 128	SRI030071KSK	13
					SRI031071KSK	9
					SRI032071KSK	7
					SRI033071KSK	5
					SRI034071KSK	5
					SRI035071KSK	4
					SRI035071KSK	4
7	D4FB5P	1582	94	128	SRI035071KSK	4
8	D4FC	1396	55 66	75 90	SRI033071KSK	5
					SRI035071KSK	4
9	D4FCM	1396	57	78	SRI035071KSK	4
10	D4FD	1685	85 103	116 140	SRI035071KSK	4





<b>HYUNDAI</b>						
engine	c.c.	kw	hp	SRI part number	pcs	
1	D3FA	1120	55	75	SRI030071KSK	13
					SRI031071KSK	9
					SRI032071KSK	7
					SRI033071KSK	5
					SRI034071KSK	5
					SRI035071KSK	4
2	D4CB	2497	81 125	110 170	SRI030044KSK	15
					SRI031044KSK	13
					SRI032044KSK	7
					SRI033044KSK	5
					SRI034044KSK	4
3	D4CBL	2497	120	163	SRI035044KSK	4
4	D4CBW	2497	100	136	SRI035044KSK	4



**KIT TENDICATENA PER MOTORE**





**TIMING CHAIN KIT PER ENGINE**





IVECO						
					pcs	
engine	c.c.	kw	hp	SRI part number		
1	F1AE0481A	2287	71	97	SRI030080KSK	4
2	F1AE0481B	2287	85	116	SRI030080KSK	4
3	F1AE0481FA	2287	70 78	95 106	SRI030080KSK	4
4	F1AE0481GA	2287	85 93	116 126	SRI030080KSK	4
5	F1AE0481HA	2287	100	136	SRI030080KSK	4
6	F1AE0481M	2287	100	136	SRI030080KSK	4
7	F1AE0481UA	2287	78	106	SRI030080KSK	4
8	F1AE0481UB	2287	78	106	SRI030080KSK	4
9	F1AE0481V	2287	93	126	SRI030080KSK	4
10	F1AE0481VA	2287	93	126	SRI030080KSK	4
11	F1AE0481VB	2287	93	126	SRI030080KSK	4
12	F1AE3481A	2287	78	106	SRI030080KSK	4
13	F1AE3481B	2287	93	126	SRI030080KSK	4
14	F1AE3481C	2287	107	146	SRI030080KSK	4
15	F1AFL411A	2287	78	106	SRI030080KSK	4
16	F1AFL411B	2287	93	126	SRI030080KSK	4
17	F1AFL411C	2287	107	146	SRI030080KSK	4
18	F1CE0441A	2998	100	136	SRI031023KSK	19
					SRI032023KSK	9
					SRI033023KSK	6
					SRI034023KSK	8
					SRI035023KSK	6
					SRI036023KSK	5
19	F1CE0481A	2998	100 114	136 155	SRI030080KSK	4
					SRI031023KSK	19
					SRI032023KSK	9
					SRI033023KSK	6
					SRI034023KSK	8
					SRI035023KSK	6
					SRI036023KSK	5
					20	F1CE0481B
SRI031023KSK	19					
SRI032023KSK	9					
SRI033023KSK	6					
SRI034023KSK	8					
SRI035023KSK	6					
SRI036023KSK	5					

IVECO						
					pcs	
engine	c.c.	kw	hp	SRI part number		
21	F1CE0481FA	2998	107 110	146 150	SRI030080KSK	4
					SRI031023KSK	19
					SRI032023KSK	9
					SRI033023KSK	6
					SRI034023KSK	8
					SRI035023KSK	6
22	F1CE0481HA	2998	125 130	170 177	SRI030080KSK	4
					SRI031023KSK	19
					SRI032023KSK	9
					SRI033023KSK	6
					SRI034023KSK	8
					SRI035023KSK	6
23	F1CE0481HC	2998	129 130	175 177	SRI030080KSK	4
					SRI031023KSK	19
					SRI032023KSK	9
					SRI033023KSK	6
					SRI034023KSK	8
					SRI035023KSK	6
24	F1CE0481L	2998	107 110	146 150	SRI030080KSK	4
					SRI031023KSK	19
					SRI032023KSK	9
					SRI033023KSK	6
					SRI034023KSK	8
					SRI035023KSK	6
					SRI036023KSK	5
					25	F1CE0481P
SRI032023KSK	9					
SRI033023KSK	6					
SRI034023KSK	8					
SRI035023KSK	6					
SRI036023KSK	5					
26	F1CE3481C	2998	125	170	SRI030077KSK	19
					SRI031077KSK	8
					SRI032077KSK	3
					SRI033077KSK	5

**KIT TENDICATENA PER MOTORE**







**TIMING CHAIN KIT PER ENGINE**













IVECO						
						
engine	c.c.	kw	hp	SRI part number	pcs	
27	F1CE3481CA	2998	125	170	SRI030077KSK	19
					SRI030080KSK	4
					SRI031077KSK	8
					SRI032077KSK	3
					SRI033077KSK	5
28	F1CE3481CB	2998	125	170	SRI030077KSK	19
					SRI030080KSK	4
					SRI031077KSK	8
					SRI032077KSK	3
					SRI033077KSK	5
29	F1CE3481D	2998	150	204	SRI030077KSK	19
					SRI031077KSK	8
					SRI032077KSK	3
					SRI033077KSK	5
30	F1CE3481J	2998	107	146	SRI030077KSK	19
					SRI030080KSK	4
					SRI031077KSK	8
					SRI032077KSK	3
					SRI033077KSK	5
31	F1CE3481K	2998	125	170	SRI030077KSK	19
					SRI031077KSK	8
					SRI032077KSK	3
					SRI033077KSK	5
32	F1CE3481L	2998	107 110	146 150	SRI030077KSK	19
					SRI031077KSK	8
					SRI032077KSK	3
					SRI033077KSK	5
33	F1CE3481LC	2998	100 103	136 140	SRI030077KSK	19
					SRI031077KSK	8
					SRI032077KSK	3
					SRI033077KSK	5

IVECO						
						
engine	c.c.	kw	hp	SRI part number	pcs	
34	F1CFA401A	2998	100	136	SRI031023KSK	19
					SRI032023KSK	9
					SRI033023KSK	6
					SRI034023KSK	8
					SRI035023KSK	6
					SRI036023KSK	5
35	F1CFL411E	2998	107	146	SRI030077KSK	19
					SRI030080KSK	4
					SRI031077KSK	8
					SRI032077KSK	3
					SRI033077KSK	5
36	F1CFL411F	2998	125	170	SRI030077KSK	19
					SRI031077KSK	8
					SRI032077KSK	3
					SRI033077KSK	5
37	F1CFL411G	2998	150	204	SRI030077KSK	19
					SRI031077KSK	8
					SRI032077KSK	3
					SRI033077KSK	5
38	F1CFL411H	2998	125	170	SRI030077KSK	19
					SRI031077KSK	8
					SRI032077KSK	3
					SRI033077KSK	5
39	F1CFL411J	2998	107	146	SRI030077KSK	19
					SRI030080KSK	4
					SRI031077KSK	8
					SRI032077KSK	3
					SRI033077KSK	5

**KIT TENDICATENA PER MOTORE**

**TIMING CHAIN KIT PER ENGINE**

<b>KIA</b>								
								
engine	c.c.	kw	hp	SRI part number	pcs			
1	D3FA	1120	55	75	SRI030071KSK	13		
					SRI031071KSK	9		
					SRI032071KSK	7		
					SRI033071KSK	5		
					SRI034071KSK	5		
					SRI035071KSK	4		
					SRI030044KSK	15		
2	D4CB	2497	103 125	140 170	SRI031044KSK	13		
					SRI032044KSK	7		
					SRI033044KSK	5		
					SRI034044KSK	4		
					SRI035044KSK	4		
					SRI033071KSK	5		
					SRI035071KSK	4		
3	D4FA	1493	58 65	79 88	SRI030071KSK	13		
					SRI031071KSK	9		
					SRI032071KSK	7		
					SRI033071KSK	5		
					SRI034071KSK	5		
			75 81	102 110	SRI035071KSK	4		
					SRI030071KSK	13		
					SRI031071KSK	9		
					SRI032071KSK	7		
					SRI033071KSK	5		
4	D4FB	1582	81 100	110 136	SRI035071KSK	4		
					SRI030071KSK	13		
					SRI031071KSK	9		
					SRI032071KSK	7		
					SRI033071KSK	5		
			85	116	SRI034071KSK	5		
					SRI035071KSK	4		
					94	128	SRI033071KSK	5
							SRI035071KSK	4
					5	D4FB5	1582	94
SRI035071KSK	4							
6	D4FBL	1582	66	90				
					SRI031071KSK	9		
					SRI032071KSK	7		
					SRI033071KSK	5		
					SRI034071KSK	5		
					SRI035071KSK	4		
					SRI033071KSK	5		
7	D4FC	1396	55 66	75 90	SRI035071KSK	4		
					SRI033071KSK	5		
8	D4FD	1685	100	136	SRI035071KSK	4		
9	D4FDL	1685	85 100	116 136	SRI035071KSK	4		

<b>LADA</b>						
						
engine	c.c.	kw	hp	SRI part number	pcs	
1	BA32103	1452	55	75	SRI039012KSK	4
		1568	55	75	SRI039012KSK	4
2		1294	51	69	SRI039011KSK	4
<b>LANCIA</b>						
						
engine	c.c.	kw	hp	SRI part number	pcs	
1	188A9000	1248	51	69	SRI000030KSK	15
					SRI030100KSK	9
					SRI031000KSK	25
					SRI031001KSK	26
					SRI03100PKSK	16
					SRI032000KSK	6
					SRI033000KSK	4
					SRI034000KSK	9
					SRI000030KSK	15
					SRI030100KSK	9
2	199A2000	1248	55	75	SRI031000KSK	25
					SRI031001KSK	26
					SRI03100PKSK	16
					SRI032000KSK	6
					SRI033000KSK	4
					SRI034000KSK	9
					SRI000030KSK	15
					SRI030100KSK	9
					SRI031000KSK	25
					SRI031001KSK	26
3	199A3000	1248	66 77	90 105	SRI031001KSK	26
					SRI03100PKSK	16
					SRI032000KSK	6
					SRI033000KSK	4
					SRI034000KSK	9
					SRI000030KSK	15
					SRI030100KSK	9
					SRI031000KSK	25
					SRI031001KSK	26
					SRI03100PKSK	16
4	199A9000	1248	55	75	SRI032000KSK	6
					SRI033000KSK	4
					SRI034000KSK	9
					SRI000030KSK	15
					SRI030100KSK	9
					SRI031000KSK	25
					SRI031001KSK	26
					SRI03100PKSK	16
					SRI032000KSK	6
					SRI033000KSK	4
SRI034000KSK	9					

**KIT TENDICATENA PER MOTORE**

**TIMING CHAIN KIT PER ENGINE**

<b>LANCIA</b>						
engine	c.c.	kw	hp	SRI part number	pcs	
5	199B1000	1248	70	95	SRI000030KSK	15
					SRI030075KSK	8
					SRI030100KSK	9
					SRI031000KSK	25
					SRI031001KSK	26
					SRI03100PKSK	16
					SRI032000KSK	6
					SRI033000KSK	4
					SRI034000KSK	9
					6	312A2000
SRI031055KSK	4					
7	312A5000	875	63	86	SRI030055KSK	6
					SRI031055KSK	4
8	312B1000	1248	70	95	SRI000030KSK	15
					SRI030075KSK	8
					SRI030100KSK	9
					SRI031000KSK	25
					SRI031001KSK	26
					SRI03100PKSK	16
					SRI032000KSK	6
					SRI033000KSK	4
					SRI034000KSK	9
					9	312B5000
SRI030075KSK	8					
SRI030100KSK	9					
SRI031000KSK	25					
SRI031001KSK	26					
SRI03100PKSK	16					
SRI032000KSK	6					
SRI033000KSK	4					
SRI034000KSK	9					
10	4HWDW12ATED4	2179	94	128		
11	RHKDW10UTED4	1997	88	120	SRI030059KSK	3
12	RHMDW10ATED4	1997	79	107	SRI030059KSK	3
13	RHRDW10BTED4	1997	100	136	SRI030059KSK	3
14	RHT	1997	79	107	SRI030059KSK	3
15	RHWDW10ATED4	1997	80	109	SRI030059KSK	3

<b>MERCEDES</b>						
engine	c.c.	kw	hp	SRI part number	pcs	
1	651911	2143	150	204	SRI030073KSK	6
					SRI030078KSK	6
					SRI031073KSK	4
					SRI031078KSK	4
					SRI030053KSK	6
2	M111920	1799	90	122	SRI030053KSK	6
3	M111921	1799	90	122	SRI030053KSK	6
4	M111940	1998	100	136	SRI030053KSK	6
5	M111941	1998	100	136	SRI030053KSK	6
6	M111942	1998	100	136	SRI030053KSK	6
7	M111943	1998	141	192	SRI030053KSK	6
8	M111944	1998	132 141	180 192	SRI030053KSK	6
9	M111945	1998	100	136	SRI030053KSK	6
10	M111946	1998	100	136	SRI030053KSK	6
11	M111947	1998	137	186	SRI030053KSK	6
12	M111948	1998	95	129	SRI030053KSK	6
13	M111950	1998	95	129	SRI030053KSK	6
14	M111951	1998	95	129	SRI030053KSK	6
15	M111952	1998	95	129	SRI030053KSK	6
16	M111955	1998	120	163	SRI030053KSK	6
17	M111956	1998	120	163	SRI030053KSK	6
18	M111957	1998	120	163	SRI030053KSK	6
19	M111958	1998	120	163	SRI030053KSK	6
20	M111960	2199	110	150	SRI030053KSK	6
21	M111961	2199	110	150	SRI030053KSK	6
22	M111970	2295	110	150	SRI030053KSK	6
23	M111973	2295	142	193	SRI030053KSK	6
24	M111974	2295	110	150	SRI030053KSK	6
25	M111975	2295	142	193	SRI030053KSK	6
26	M111977	2295	110	150	SRI030053KSK	6
27	M111978	2295	105	143	SRI030053KSK	6
28	M111979	2295	105	143	SRI030053KSK	6
29	M111980	2295	105	143	SRI030053KSK	6
30	M111981	2295	145	197	SRI030053KSK	6
31	M111982	2295	145	197	SRI030053KSK	6
32	M111983	2295	145	197	SRI030053KSK	6
33	M111984	2295	92 105	125 143	SRI030053KSK	6
34	M166940	1397	60	82	SRI032033KSK	5
					SRI033033KSK	4
35	M166960	1598	60 75	82 102	SRI032033KSK	5
					SRI033033KSK	4

<b>MAZDA</b>						
engine	c.c.	kw	hp	SRI part number	pcs	
1	Y601	1560	80	109	SRI030047KSK	2
2	Y642	1560	80	109	SRI030047KSK	2

**KIT TENDICATENA PER MOTORE**







**TIMING CHAIN KIT PER ENGINE**







MERCEDES						
engine	c.c.	kw	hp	SRI part number	pcs	
36	M166961	1598	60	SRI032033KSK	5	
			75	82	SRI033033KSK	4
37	M166990	1898	92	SRI032033KSK	5	
			125	125	SRI033033KSK	4
38	M166991	1898	92	SRI032033KSK	5	
			125	125	SRI033033KSK	4
39	M166995	2084	103	SRI032033KSK	5	
			140	140	SRI033033KSK	4
40	M271820	1796	115	SRI032056KSK	2	
			135	156	SRI032056KSK	2
41	M271860	1796	135	SRI032056KSK	2	
			184	184	SRI032056KSK	2
42	M271861	1796	150	SRI032056KSK	2	
			204	204	SRI032056KSK	2
43	M271910	1597	135	SRI032056KSK	2	
			184	184	SRI032056KSK	2
44	M271911	1597	115	SRI031056KSK	5	
			156	156	SRI930056KSK	10
45	M271921	1796	95	SRI031056KSK	5	
			129	129	SRI930056KSK	10
46	M271940	1796	90	SRI030056KSK	8	
			122	SRI031056KSK	5	
			122	SRI032056KSK	2	
			122	SRI930056KSK	10	
47	M271941	1796	120	SRI030056KSK	8	
			163	SRI031056KSK	5	
			163	SRI032056KSK	2	
			163	SRI930056KSK	10	
48	M271942	1796	120	SRI030056KSK	8	
			163	SRI031056KSK	5	
			163	SRI032056KSK	2	
			163	SRI930056KSK	10	
49	M271944	1795	125	SRI030056KSK	8	
			170	SRI031056KSK	5	
			170	SRI032056KSK	2	
50	M271946	1796	105	SRI030056KSK	8	
			125	143	SRI031056KSK	5
			125	170	SRI032056KSK	2
			125	170	SRI930056KSK	10

MERCEDES						
engine	c.c.	kw	hp	SRI part number	pcs	
51	M271948	1796	141	192	SRI030056KSK	8
					SRI031056KSK	5
					SRI032056KSK	2
					SRI930056KSK	10
52	M271950	1796	135	184	SRI030056KSK	8
					SRI031056KSK	5
					SRI032056KSK	2
					SRI930056KSK	10
53	M271951	1796	115	156	SRI030056KSK	8
					SRI031056KSK	5
					SRI032056KSK	2
					SRI930056KSK	10
54	M271952	1796	115	156	SRI030056KSK	8
					SRI031056KSK	5
					SRI032056KSK	2
					SRI930056KSK	10
55	M271954	1796	135	184	SRI030056KSK	8
					SRI031056KSK	5
					SRI032056KSK	2
56	M271955	1796	135	184	SRI030056KSK	8
					SRI031056KSK	5
					SRI032056KSK	2
					SRI930056KSK	10
57	M271956	1796	120	SRI030056KSK	8	
			135	163	SRI031056KSK	5
			184	184	SRI032056KSK	2
			184	184	SRI930056KSK	10
58	M271957	1796	135	184	SRI030056KSK	8
					SRI031056KSK	5
					SRI032056KSK	2
					SRI930056KSK	10
59	M271958	1796	120	163	SRI030056KSK	8
					SRI031056KSK	5
					SRI032056KSK	2
					SRI930056KSK	10
60	OM611961	2148	85	116	SRI030050KSK	6
		105	105	143	SRI030050KSK	6
61	OM611962	2151	75	102	SRI030050KSK	6
		105	92	125	SRI030050KSK	6

**KIT TENDICATENA PER MOTORE**

**TIMING CHAIN KIT PER ENGINE**

<b>MERCEDES</b>						
						
engine	c.c.	kw	hp	SRI part number	pcs	
62	OM611980	2151	75 90	102 122	SRI030050KSK	6
63	OM611981	2148	80 95	109 129	SRI030050KSK	6
64	OM611987	2148	60	82	SRI030050KSK	6
65	OM612961	2685	120 125	163 170	SRI030050KSK	6
66	OM612962	2685	125	170	SRI030050KSK	6
67	OM612963	2685	120	163	SRI030050KSK	6
68	OM612965	2685	115	156	SRI030050KSK	6
69	OM612966	2685	115	156	SRI030050KSK	6
70	OM612967	2685	120 125	163 170	SRI030050KSK	6
71	OM612981	2685	115	156	SRI030050KSK	6
72	OM612990	2950	170	231	SRI030050KSK	6
73	OM613960	3222	145	197	SRI030050KSK	6
74	OM613961	3226	145	197	SRI030050KSK	6
75	OM640940	1991	80	109	SRI031079KSK	4
76	OM640941	1991	100 103	136 140	SRI031079KSK	4
77	OM640942	1991	60	82	SRI031079KSK	4
78	OM646811	2148	100 125	136 170	SRI030050KSK	6
79	OM646812	2148	100	136	SRI030050KSK	6
80	OM646820	2148	100	136	SRI030050KSK	6
81	OM646821	2148	100 125	136 170	SRI030050KSK	6
82	OM646951	2148	75 90	102 122	SRI030050KSK	6
83	OM646961	2148	100 110	136 150	SRI030050KSK	6
84	OM646962	2148	75 90	102 122	SRI030050KSK	6
85	OM646963	2148	100 110	136 150	SRI030050KSK	6
86	OM646966	2148	100 110	136 150	SRI030050KSK	6
87	OM646980	2148	70 110	95 150	SRI030050KSK	6
88	OM646981	2148	70	95	SRI030050KSK	6
89	OM646982	2148	80 110	109 150	SRI030050KSK	6
90	OM646983	2148	65	88	SRI030050KSK	6
91	OM646984	2148	65	88	SRI030050KSK	6
92	OM646985	2148	80	109	SRI030050KSK	6
93	OM646986	2148	95 110	129 150	SRI030050KSK	6
94	OM646989	2148	95 110	129 150	SRI030050KSK	6
95	OM646990	2148	110	150	SRI030050KSK	6

<b>MERCEDES</b>						
						
engine	c.c.	kw	hp	SRI part number	pcs	
96	OM647961	2685	120 130	163 177	SRI030050KSK	6
97	OM648960	3222	150	204	SRI030050KSK	6
98	OM648961	3222	130 150	177 204	SRI030050KSK	6
99	OM651901	1796	80 100	109 136	SRI030073KSK	6
				SRI030078KSK	6	
				SRI031073KSK	4	
				SRI031078KSK	4	
100	OM651911	2143	120 150	163 204	SRI030073KSK	6
				SRI030078KSK	6	
				SRI031073KSK	4	
				SRI031078KSK	4	
101	OM651912	2143	120 150	163 204	SRI030073KSK	6
				SRI030078KSK	6	
				SRI031073KSK	4	
				SRI031078KSK	4	
102	OM651913	2143	88 100	120 136	SRI030073KSK	6
				SRI030078KSK	6	
				SRI031073KSK	4	
				SRI031078KSK	4	
103	OM651916	2143	100 125	136 170	SRI030073KSK	6
				SRI030078KSK	6	
				SRI031073KSK	4	
				SRI031078KSK	4	
104	OM651921	1598	100	136	SRI030073KSK	6
		2143	100 150	136 204	SRI031073KSK	4
105	OM651924	2143	120 150	163 204	SRI030073KSK	6
				SRI030078KSK	6	
				SRI031073KSK	4	
				SRI031078KSK	4	
106	OM651925	2143	100	136	SRI030073KSK	6
				SRI030078KSK	6	
				SRI031073KSK	4	
				SRI031078KSK	4	
107	OM651930	2143	100 130	136 177	SRI030073KSK	6
				SRI031073KSK	4	

**KIT TENDICATENA PER MOTORE**

**TIMING CHAIN KIT PER ENGINE**

**MERCEDES**

engine	c.c.	kw	hp	SRI part number	pcs	
108	OM651940	2143	70 120	95 163	SRI030073KSK	6
					SRI030078KSK	6
					SRI031073KSK	4
					SRI031078KSK	4
109	OM651950	2143	100 140	136 190	SRI030073KSK	6
					SRI031073KSK	4
110	OM651955	2143	84 105	114 143	SRI030073KSK	6
					SRI031073KSK	4
			70 120	95 163	SRI030073KSK	6
					SRI030078KSK	6
					SRI031073KSK	4
					SRI031078KSK	4
111	OM651956	2143	70 95	95 129	SRI030073KSK	6
					SRI030078KSK	6
					SRI031073KSK	4
					SRI031078KSK	4
112	OM651957	2143	95 120	129 163	SRI030073KSK	6
					SRI030078KSK	6
					SRI031073KSK	4
					SRI031078KSK	4
113	OM651960	2143	150	204	SRI030073KSK	6
					SRI030078KSK	6
					SRI031073KSK	4
					SRI031078KSK	4
114	OM651961	2143	150	204	SRI030073KSK	6
					SRI030078KSK	6
					SRI031073KSK	4
					SRI031078KSK	4
115	OM651980	2143	150	204	SRI030073KSK	6
					SRI031073KSK	4

**MINI**

engine	c.c.	kw	hp	SRI part number	pcs	
1	1ND	1364	55 65	75 88	SRI030013KSK	5
2	1NDTV	1364	65	88	SRI030013KSK	5
3	9HZ	1560	66	90	SRI030047KSK	2
4	9HZDV6TED4	1560	66 80	90 109	SRI030047KSK	2
5	B37C15A	1496	70 85	95 116	SRI032043KSK	4
6	N47C16A	1598	66 82	90 112	SRI030043KSK	10
					SRI031043KSK	6
					SRI032043KSK	4
					SRI033043KSK	4
7	N47C20A	1995	82 105	112 143	SRI030043KSK	10
					SRI031043KSK	6
					SRI032043KSK	4
					SRI033043KSK	4
8	W16D16	1560	80	109	SRI030047KSK	2

**MITSUBISHI**

engine	c.c.	kw	hp	SRI part number	pcs	
1	4M40A	2835	71	97	SRI031018KSK	9
					SRI032018KSK	4
2	4M40T	2835	92	125	SRI031018KSK	9
					SRI032018KSK	4
3	4M41	3200	118 121	160 165	SRI030019KSK	10
					SRI031019KSK	6
					SRI032019KSK	4
					SRI033019KSK	12

**KIT TENDICATENA PER MOTORE**

**TIMING CHAIN KIT PER ENGINE**

NISSAN						
engine	c.c.	kw	hp	SRI part number	pcs	
1	CG10DE	998	40	54	SRI030004KSK	11
					SRI031004KSK	4
					SRI032004KSK	6
			48	65	SRI030005KSK	7
					SRI031005KSK	4
					SRI930005KSK	8
2	CG13DE	1275	55	75	SRI030004KSK	11
					SRI031004KSK	4
					SRI032004KSK	6
3	GA14DE	1392	55 64	75 87	SRI030002KSK	18
					SRI031002KSK	4
					SRI032002KSK	7
4	GA14DS	1392	55	75	SRI030002KSK	18
					SRI031002KSK	4
					SRI032002KSK	7
5	GA16DE	1597	66	90	SRI030002KSK	18
					SRI031002KSK	4
					SRI032002KSK	7
			73	99	SRI031002KSK	4
					SRI032002KSK	7
					SRI030002KSK	18
75 82	102 112	SRI031002KSK	4			
		SRI032002KSK	7			
		SRI030002KSK	18			
6	GA16DS	1597	66	90	SRI030002KSK	18
					SRI031002KSK	4
					SRI032002KSK	7
7	M9R	1995	110 130	150 177	SRI030041KSK	13
					SRI031041KSK	4
8	M9R630A6	1995	66 84	90 114	SRI030041KSK	13
					SRI031041KSK	4
9	M9R692F6	1995	66 84	90 114	SRI030041KSK	13
					SRI031041KSK	4
10	M9R760	1995	127	173	SRI030041KSK	13
					SRI031041KSK	4
11	M9R780	1995	84	114	SRI030041KSK	13
					SRI031041KSK	4
12	M9R782	1995	66	90	SRI030041KSK	13
					SRI031041KSK	4
13	M9R786M7	1995	66 84	90 114	SRI030041KSK	13
					SRI031041KSK	4
14	YD25DDTI	2488	81 140	110 190	SRI030072KSK	15
					SRI031072KSK	11

OPEL						
engine	c.c.	kw	hp	SRI part number	pcs	
1	A10XEP	998	44 48	60 65	SRI031070KSK	5
2	A12XEL	1229	51	69	SRI031070KSK	5
3	A12XER	1229	61 63	83 86	SRI031070KSK	5
4	A13DTC	1248	55	75	SRI000030KSK	15
					SRI030075KSK	8
					SRI030100KSK	9
					SRI031000KSK	25
					SRI031001KSK	26
					SRI03100PKSK	16
5	A13DTE	1248	70	95	SRI032000KSK	6
					SRI033000KSK	4
					SRI034000KSK	9
					SRI000030KSK	15
					SRI030075KSK	8
					SRI030100KSK	9
6	A13DTR	1248	70	95	SRI031000KSK	25
					SRI031001KSK	26
					SRI03100PKSK	16
					SRI032000KSK	6
					SRI033000KSK	4
					SRI034000KSK	9
7	A13FD	1248	55 66	75 90	SRI000030KSK	15
					SRI030075KSK	8
					SRI030100KSK	9
					SRI031000KSK	25
					SRI031001KSK	26
					SRI03100PKSK	16
8	A13DTR	1248	70	95	SRI032000KSK	6
					SRI033000KSK	4
					SRI034000KSK	9
					SRI000030KSK	15
					SRI030075KSK	8
					SRI030100KSK	9
9	A13DTR	1248	70	95	SRI031000KSK	25
					SRI031001KSK	26
					SRI03100PKSK	16
					SRI032000KSK	6
					SRI033000KSK	4
					SRI034000KSK	9
10	A13DTR	1248	70	95	SRI000030KSK	15
					SRI030075KSK	8
					SRI030100KSK	9
					SRI031000KSK	25
					SRI031001KSK	26
					SRI03100PKSK	16
11	A13DTR	1248	70	95	SRI032000KSK	6
					SRI033000KSK	4
					SRI034000KSK	9
					SRI000030KSK	15
					SRI030075KSK	8
					SRI030100KSK	9
12	A13DTR	1248	70	95	SRI031000KSK	25
					SRI031001KSK	26
					SRI03100PKSK	16
					SRI032000KSK	6
					SRI033000KSK	4
					SRI034000KSK	9
13	A13DTR	1248	70	95	SRI000030KSK	15
					SRI030075KSK	8
					SRI030100KSK	9
					SRI031000KSK	25
					SRI031001KSK	26
					SRI03100PKSK	16
14	A13DTR	1248	70	95	SRI032000KSK	6
					SRI033000KSK	4
					SRI034000KSK	9
					SRI000030KSK	15
					SRI030075KSK	8
					SRI030100KSK	9



**KIT TENDICATENA PER MOTORE**

**TIMING CHAIN KIT PER ENGINE**

OPEL						
engine	c.c.	kw	hp	SRI part number	pcs	
8	A14NEL	1364	88	120	SRI031070KSK	5
9	A14NET	1364	88 103	120 140	SRI031070KSK	5
10	A14XEL	1398	64	87	SRI031070KSK	5
11	A14XER	1398	74	101	SRI031070KSK	5
12	A14XFL	1398	111	151	SRI031070KSK	5
13	A20NFT	1998	162 206	220 280	SRI032058KSK	7
14	A20NHT	1998	162 184	220 250	SRI032058KSK	7
15	A24XE	2384	123	167	SRI032058KSK	7
16	A24XELE9	2384	123	167	SRI032058KSK	7
17	B12XEL	1229	51	69	SRI031070KSK	5
18	B14NEH	1364	110	150	SRI031070KSK	5
19	B14NEHLUJ	1398	103	140	SRI031070KSK	5
20	B14NEJ	1364	74	101	SRI031070KSK	5
21	B14NEL	1364	88	120	SRI031070KSK	5
22	B14NELLUH	1364	88	120	SRI031070KSK	5
23	B14NET	1364	103 110	140 150	SRI031070KSK	5
24	B14NETLUJ	1364	105	143	SRI031070KSK	5
25	B14XEJ	1398	55	75	SRI031070KSK	5
26	B14XEL	1398	64 66	87 90	SRI031070KSK	5
27	B14XER	1398	74	101	SRI031070KSK	5
28	B14XERLDD	1398	64 74	87 101	SRI031070KSK	5
29	B20NFT	1998	206	280	SRI032058KSK	7
30	M9R630	1995	66 84	90 114	SRI030041KSK	13
				SRI031041KSK	4	
31	M9R692	1995	84	114	SRI030041KSK	13
				SRI031041KSK	4	
32	M9R780	1995	66 84	90 114	SRI030041KSK	13
				SRI031041KSK	4	
33	M9R782	1995	66	90	SRI030041KSK	13
				SRI031041KSK	4	
34	M9R784	1995	84	114	SRI030041KSK	13
				SRI031041KSK	4	
35	M9R786	1995	66 84	90 114	SRI030041KSK	13
				SRI031041KSK	4	
36	M9R788	1995	84	114	SRI030041KSK	13
				SRI031041KSK	4	
37	X10XE	973	40	54	SRI030024KSK	12
				SRI031024KSK	5	

OPEL						
engine	c.c.	kw	hp	SRI part number	pcs	
38	X12XE	1199	48	65	SRI030024KSK	12
				SRI031024KSK	5	
39	X20DTH	1995	74	101	SRI030048KSK	17
				SRI031048KSK	4	
				SRI032048KSK	4	
				SRI033048KSK	8	
40	X20DTL	1995	60 63	82 86	SRI030048KSK	17
				SRI031048KSK	4	
				SRI032048KSK	4	
				SRI033048KSK	8	
41	X22DTH	2171	85	116	SRI031048KSK	4
				SRI032048KSK	4	
				SRI033048KSK	8	
42	Y13DT	1248	51	69	SRI030100KSK	9
43	Y20DTH	1995	74	101	SRI030048KSK	17
				SRI031048KSK	4	
				SRI032048KSK	4	
				SRI033048KSK	8	
44	Y20DTL	1995	60	82	SRI030048KSK	17
				SRI031048KSK	4	
				SRI032048KSK	4	
				SRI033048KSK	8	
45	Y22DTH	2171	81 88	110 120	SRI030048KSK	17
				SRI031048KSK	4	
				SRI032048KSK	4	
				SRI033048KSK	8	
46	Y22DTR	2171	86 92	117 125	SRI030048KSK	17
				SRI031048KSK	4	
				SRI032048KSK	4	
				SRI033048KSK	8	
		2172	86 92	117 125	SRI030048KSK	17
				SRI031048KSK	4	
				SRI032048KSK	4	
				SRI033048KSK	8	
47	Z10XE	973	43	58	SRI030024KSK	12
				SRI031024KSK	5	
48	Z10XEP	998	44	60	SRI030024KSK	12
				SRI031024KSK	5	

**KIT TENDICATENA PER MOTORE**

**TIMING CHAIN KIT PER ENGINE**

OPEL						
engine	c.c.	kw	hp	SRI part number	pcs	
49	Z12XE	1199	55	75	SRI030024KSK	12
					SRI031024KSK	5
50	Z12XEP	1229	55 59	75 80	SRI030070KSK	10
					SRI031024KSK	5
					SRI031070KSK	5
					SRI932070KSK	12
					SRI030024KSK	12
51	Z13DT	1248	51	69	SRI000030KSK	15
					SRI030075KSK	8
					SRI030100KSK	9
					SRI031000KSK	25
					SRI031001KSK	26
					SRI03100PKSK	16
					SRI032000KSK	6
					SRI033000KSK	4
					SRI034000KSK	9
					52	Z13DTE
SRI030075KSK	8					
SRI030100KSK	9					
SRI031000KSK	25					
SRI031001KSK	26					
SRI03100PKSK	16					
SRI032000KSK	6					
SRI033000KSK	4					
53	Z13DTH	1248	66	90	SRI000030KSK	15
					SRI030075KSK	8
					SRI030100KSK	9
					SRI031000KSK	25
					SRI031001KSK	26
					SRI03100PKSK	16
					SRI032000KSK	6
					SRI033000KSK	4
					SRI034000KSK	9

OPEL						
engine	c.c.	kw	hp	SRI part number	pcs	
54	Z13DTJ	1248	55	75	SRI000030KSK	15
					SRI030075KSK	8
					SRI030100KSK	9
					SRI031000KSK	25
					SRI031001KSK	26
					SRI03100PKSK	16
					SRI032000KSK	6
					SRI033000KSK	4
					SRI034000KSK	9
					55	Z14XEL
SRI031024KSK	5					
SRI031070KSK	5					
56	Z14XEP	1364	66	90	SRI030024KSK	12
					SRI030070KSK	10
					SRI031024KSK	5
					SRI031070KSK	5
					SRI031045KSK	5
57	Z20NET	1998	129	175	SRI031058KSK	6
					SRI032058KSK	7
58	Z20NHH	1998	194	264	SRI030058KSK	17
					SRI030065KSK	16
					SRI031045KSK	5
					SRI031058KSK	6
					SRI031065KSK	13
					SRI032065KSK	14
					SRI030045KSK	17
60	Z22SE	2198	108	147	SRI030065KSK	16
					SRI031045KSK	5
					SRI031058KSK	6
					SRI031065KSK	13
					SRI032065KSK	14
					SRI030045KSK	17
					SRI030065KSK	16
					SRI031045KSK	5
					SRI031058KSK	6
61	Z22YH	2198	110 114	150 155	SRI031065KSK	13
					SRI032065KSK	14
					SRI030045KSK	17
					SRI030065KSK	16
					SRI031045KSK	5

**KIT TENDICATENA PER MOTORE**

**TIMING CHAIN KIT PER ENGINE**

PEUGEOT						
engine	c.c.	kw	hp	SRI part number	pcs	
1	108CXV8	954	33	45	SRI039014KSK	6
2	109FXW7	1124	37	50	SRI039014KSK	6
3	150XY6B	1360	53	72	SRI039013KSK	5
4	199A9000	1248	55	75	SRI000030KSK	15
					SRI030075KSK	8
					SRI030100KSK	9
					SRI031000KSK	25
					SRI031001KSK	26
					SRI03100PKSK	16
					SRI032000KSK	6
					SRI033000KSK	4
					SRI034000KSK	9
					SRI030017KSK	7
5	1KR384F	998	50	68	SRI031017KSK	4
					SRI930017KSK	8
					SRI031017KSK	4
6	1KRFE	998	51	69	SRI031017KSK	4
					SRI030017KSK	7
					SRI031017KSK	4
7	384F	998	50	68	SRI030017KSK	8
					SRI031017KSK	4
					SRI930017KSK	8
8	4HGP22DTE	2198	81	110	SRI030067KSK	6
					SRI031067KSK	9
9	4HHP22DTE	2198	96	131	SRI030067KSK	6
					SRI031067KSK	9
10	4HJP22DTE	2198	110	150	SRI030067KSK	6
					SRI031067KSK	9
11	4HUP22DTE	2198	88	120	SRI030067KSK	6
					SRI031067KSK	9
12	4HVP22DTE	2198	74	101	SRI030067KSK	6
					SRI031067KSK	9
13	4HZDW12TED4	2179	94	128	SRI030059KSK	3
					SRI030074KSK	6
14	5F01EP6C	1598	88	120	SRI031074KSK	5
					SRI030046KSK	7
15	5F02EP6CDT	1598	115 92	156 125	SRI031046KSK	5
					SRI931046KSK	9
					SRI030046KSK	7
16	5F04EP6CDT	1598	115	156	SRI031046KSK	5
					SRI931046KSK	9
					SRI030046KSK	7
17	5FAEP6CDT	1598	92	125	SRI031046KSK	5
					SRI931046KSK	9
					SRI030046KSK	7
18	5FEFP6CDTMD	1598	110	150	SRI031046KSK	5
					SRI931046KSK	9
					SRI030046KSK	7

PEUGEOT						
engine	c.c.	kw	hp	SRI part number	pcs	
19	5FGEP6CDTR	1598	199	271	SRI030074KSK	6
					SRI031074KSK	5
20	5FKEP6CB	1598	72	98	SRI030074KSK	6
					SRI031074KSK	5
21	5FMEP6CDTM	1598	120	163	SRI030046KSK	7
					SRI031046KSK	5
					SRI931046KSK	9
22	5FNFP6CDT	1598	110	150	SRI030046KSK	7
					SRI031046KSK	5
					SRI931046KSK	9
23	5FREP6DT	1598	115	156	SRI030046KSK	7
					SRI031046KSK	5
					SRI931046KSK	9
24	5FSEP6C	1598	88	120	SRI030074KSK	6
					SRI031074KSK	5
					SRI030046KSK	7
25	5FTEP6DT	1598	103	140	SRI031046KSK	5
					SRI931046KSK	9
					SRI030074KSK	6
26	5FUEP6CDTX	1598	147	200	SRI031074KSK	5
					SRI030046KSK	7
27	5FVEP6CDT	1598	115	156	SRI031046KSK	5
					SRI931046KSK	9
					SRI030046KSK	7
28	5FVEP6DT	1598	115	156	SRI030046KSK	7
					SRI031046KSK	5
					SRI931046KSK	9
29	5FXEP6DT	1598	110	150	SRI030046KSK	7
					SRI031046KSK	5
					SRI931046KSK	9
30	5FYEP6DTS	1598	128	174	SRI030046KSK	7
					SRI031046KSK	5
					SRI931046KSK	9
31	5G02EP6FDTM	1598	120 121	163 165	SRI030046KSK	7
					SRI031046KSK	5
					SRI931046KSK	9
32	5G02EP6FDTMD	1598	110	150	SRI030046KSK	7
					SRI031046KSK	5
					SRI931046KSK	9
33	5GTEP6FDTX	1598	151	205	SRI030074KSK	6
					SRI031074KSK	5
34	5GXEP6FDTMD	1598	110	150	SRI030046KSK	7
					SRI031046KSK	5
					SRI931046KSK	9

**KIT TENDICATENA PER MOTORE**

**TIMING CHAIN KIT PER ENGINE**

PEUGEOT						
engine	c.c.	kw	hp	SRI part number	pcs	
35	5GYEP6FDTM	1598	120 121	163 165	SRI030046KSK	7
					SRI031046KSK	5
					SRI931046KSK	9
36	5GZEP6FDT	1598	120 121	163 165	SRI030046KSK	7
					SRI031046KSK	5
					SRI931046KSK	9
37	8F01EP3C	1397	70	95	SRI030074KSK	6
					SRI031074KSK	5
38	8FPEP3C	1397	70	95	SRI030074KSK	6
					SRI031074KSK	5
39	8FREPE3	1397	72	98	SRI030074KSK	6
					SRI031074KSK	5
40	8FREPE3C	1397	72	98	SRI030074KSK	6
					SRI031074KSK	5
41	8FSEP3	1397	70	95	SRI030074KSK	6
					SRI031074KSK	5
42	9H01DV6TED4	1560	66 80	90 109	SRI030047KSK	2
					SRI030047KSK	2
43	9H02DV6B	1560	55	75	SRI030047KSK	2
44	9HSDV6TED4BU	1560	66	90	SRI030047KSK	2
45	9HTDV6BUTED4	1560	55	75	SRI030047KSK	2
46	9HUDV6UTED4	1560	66	90	SRI030047KSK	2
47	9HVDV6ATED4	1560	66	90	SRI030047KSK	2
48	9HVDV6TED4	1560	66	90	SRI030047KSK	2
49	9HWDV6B	1560	55	75	SRI030047KSK	2
50	9HXDV6ATED4	1560	66	90	SRI030047KSK	2
51	9HXDV6AUTED4	1560	66	90	SRI030047KSK	2
52	9HYDV6TED4	1560	80	109	SRI030047KSK	2
53	9HZDV6TED4	1560	80	109	SRI030047KSK	2
54	AHYDW10CE	1997	72	98	SRI030059KSK	3
55	AHZDW10CD	1997	94	128	SRI030059KSK	3
56	CFA384F	998	50	68	SRI030017KSK	7
					SRI031017KSK	4
					SRI930017KSK	8
57	EP3	1397	70	95	SRI030074KSK	6
					SRI031074KSK	5
58	EP3C	1397	70	95	SRI030074KSK	6
					SRI031074KSK	5
59	EP6	1598	88	120	SRI030074KSK	6
					SRI031074KSK	5
60	EP6C5FH	1598	85	116	SRI030074KSK	6
					SRI031074KSK	5
61	EP6C5FK	1598	72	98	SRI030074KSK	6
					SRI031074KSK	5

PEUGEOT						
engine	c.c.	kw	hp	SRI part number	pcs	
62	EP6CDT	1598	115	156	SRI030046KSK	7
					SRI031046KSK	5
					SRI931046KSK	9
63	EP6CDTM5FM	1598	120	163	SRI030046KSK	7
					SRI031046KSK	5
					SRI931046KSK	9
64	EP6CDTX	1598	147	200	SRI030074KSK	6
					SRI031074KSK	5
65	EP6FDTMD	1598	110	150	SRI030046KSK	7
					SRI031046KSK	5
					SRI931046KSK	9
66	EP6FDTR5GN	1598	184 200	250 272	SRI030074KSK	6
					SRI031074KSK	5
67	EP6FDTX	1598	151 153	205 208	SRI030074KSK	6
					SRI031074KSK	5
68	F1	1204	47	64	SRI039014KSK	6
69	F1CE0481DF30DT	2999	115 130	156 177	SRI031023KSK	19
					SRI032023KSK	9
					SRI033023KSK	6
					SRI034023KSK	8
					SRI035023KSK	6
70	F30DT	2999	116	158	SRI036023KSK	5
					SRI031023KSK	19
					SRI032023KSK	9
					SRI033023KSK	6
					SRI034023KSK	8
71	FHYP13DTE6	1248	59	80	SRI035023KSK	6
					SRI036023KSK	5
					SRI000030KSK	15
					SRI030075KSK	8
					SRI030100KSK	9
72	FHZF13DTE5	1248	55	75	SRI031000KSK	25
					SRI031001KSK	26
					SRI03100PKSK	16
					SRI032000KSK	6
					SRI033000KSK	4

**KIT TENDICATENA PER MOTORE**

**TIMING CHAIN KIT PER ENGINE**

<b>PEUGEOT</b>						
engine	c.c.	kw	hp	SRI part number	pcs	
73	RH01DW10BTED4	1997	103	140	SRI030059KSK	3
74	RH02DW10CTED4	1997	120	163	SRI030059KSK	3
75	RHCDW10CTED4	1997	120 147	163 200	SRI030059KSK	3
76	RHDDW10CTED4	1997	100	136	SRI030059KSK	3
77	RHEDW10CTED4	1997	110	150	SRI030059KSK	3
78	RHFDW10BTED4	1997	100 103	136 140	SRI030059KSK	3
79	RHGDW10UTED4	1997	88	120	SRI030059KSK	3
80	RHHDW10CTED4	1997	120 147	163 200	SRI030059KSK	3
81	RHKDW10UTED4	1997	88	120	SRI030059KSK	3
82	RHLDW10BTED4	1997	93	126	SRI030059KSK	3
83	RHRDW10BTED4	1997	100 103	136 140	SRI030059KSK	3





<b>RENAULT</b>						
engine	c.c.	kw	hp	SRI part number	pcs	
16	M9R760	1995	110 127	150 173	SRI030041KSK	13
				SRI031041KSK	4	
17	M9R761	1995	96 127	131 173	SRI030041KSK	13
				SRI031041KSK	4	
18	M9R762	1995	96 127	131 173	SRI030041KSK	13
				SRI031041KSK	4	
19	M9R763	1995	96 127	131 173	SRI030041KSK	13
				SRI031041KSK	4	
20	M9R780	1995	66 85	90 116	SRI030041KSK	13
				SRI031041KSK	4	
21	M9R782	1995	66 85	90 116	SRI030041KSK	13
				SRI031041KSK	4	
22	M9R784	1995	66	90	SRI030041KSK	13
				SRI031041KSK	4	
23	M9R786	1995	66 85	90 116	SRI030041KSK	13
				SRI031041KSK	4	
24	M9R800	1995	127	173	SRI030041KSK	13
				SRI031041KSK	4	
25	M9R802	1995	96 110	131 150	SRI030041KSK	13
				SRI031041KSK	4	
26	M9R804	1995	127	173	SRI030041KSK	13
				SRI031041KSK	4	
27	M9R805	1995	110	150	SRI030041KSK	13
				SRI031041KSK	4	
28	M9R806	1995	127	173	SRI030041KSK	13
				SRI031041KSK	4	
29	M9R808	1995	110	150	SRI030041KSK	13
				SRI031041KSK	4	
30	M9R809	1995	127	173	SRI030041KSK	13
				SRI031041KSK	4	
31	M9R811	1995	127	173	SRI030041KSK	13
				SRI031041KSK	4	
32	M9R812K8	1995	127	173	SRI030041KSK	13
				SRI031041KSK	4	
33	M9R814	1995	96 110	131 150	SRI030041KSK	13
				SRI031041KSK	4	
34	M9R815	1995	110 127	150 173	SRI030041KSK	13
				SRI031041KSK	4	
35	M9R816	1995	131	178	SRI030041KSK	13
				SRI031041KSK	4	
36	M9R817	1995	127	173	SRI030041KSK	13
				SRI031041KSK	4	
37	M9R820	1995	131	178	SRI030041KSK	13
				SRI031041KSK	4	
38	M9R824	1995	110	150	SRI030041KSK	13
				SRI031041KSK	4	

<b>RENAULT</b>						
engine	c.c.	kw	hp	SRI part number	pcs	
1	689710	956	31 32	42 44	SRI039017KSK	5
2	C1C708	956	25	34	SRI039017KSK	5
3	M9R610	1995	118 120	160 163	SRI030041KSK	13
				SRI031041KSK	4	
4	M9R615	1995	110	150	SRI030041KSK	13
				SRI031041KSK	4	
5	M9R630	1995	66 84	90 114	SRI030041KSK	13
				SRI031041KSK	4	
6	M9R692	1995	66 84	90 114	SRI030041KSK	13
				SRI031041KSK	4	
7	M9R700	1995	110	150	SRI030041KSK	13
				SRI031041KSK	4	
8	M9R721	1995	110	150	SRI030041KSK	13
				SRI031041KSK	4	
9	M9R722	1995	110	150	SRI030041KSK	13
				SRI031041KSK	4	
10	M9R724	1995	127	173	SRI030041KSK	13
				SRI031041KSK	4	
11	M9R740	1995	96 110	131 150	SRI030041KSK	13
				SRI031041KSK	4	
12	M9R742	1995	96	131	SRI030041KSK	13
				SRI031041KSK	4	
13	M9R744	1995	96	131	SRI030041KSK	13
				SRI031041KSK	4	
14	M9R750	1995	96 110	131 150	SRI030041KSK	13
				SRI031041KSK	4	
15	M9R756	1995	96	131	SRI030041KSK	13
				SRI031041KSK	4	





**KIT TENDICATENA PER MOTORE**

**TIMING CHAIN KIT PER ENGINE**





**RENAULT**

						
	engine	c.c.	kw	hp	SRI part number	pcs
39	M9R830	1995	127 130	173 177	SRI030041KSK	13
					SRI031041KSK	4
40	M9R832	1995	110	150	SRI030041KSK	13
					SRI031041KSK	4
41	M9R834V8	1995	127	173	SRI030041KSK	13
					SRI031041KSK	4
42	M9R83528	1995	127	173	SRI030041KSK	13
					SRI031041KSK	4
43	M9R836H8	1995	110	150	SRI030041KSK	13
					SRI031041KSK	4
44	M9R839	1995	127	173	SRI030041KSK	13
					SRI031041KSK	4
45	M9R844	1995	127	173	SRI030041KSK	13
					SRI031041KSK	4
46	M9R845	1995	110	150	SRI030041KSK	13
					SRI031041KSK	4
47	M9R846	1995	110	150	SRI030041KSK	13
					SRI031041KSK	4
48	M9R849	1995	127	173	SRI030041KSK	13
					SRI031041KSK	4
49	M9R855	1995	110	150	SRI030041KSK	13
					SRI031041KSK	4
50	M9R856	1995	110	150	SRI030041KSK	13
					SRI031041KSK	4
51	M9R857	1995	110 127	150 173	SRI030041KSK	13
					SRI031041KSK	4
52	M9R858	1995	96 110	131 150	SRI030041KSK	13
					SRI031041KSK	4
53	M9R859	1995	127	173	SRI030041KSK	13
					SRI031041KSK	4
54	M9R862	1995	110	150	SRI030041KSK	13
					SRI031041KSK	4
55	M9R864	1995	127	173	SRI030041KSK	13
					SRI031041KSK	4
56	M9R865	1995	110 127	150 173	SRI030041KSK	13
					SRI031041KSK	4
57	M9R866	1995	110	150	SRI030041KSK	13
					SRI031041KSK	4
58	M9RA700	1995	110	150	SRI030041KSK	13
					SRI031041KSK	4
59	M9RA742	1995	96 110	131 150	SRI030041KSK	13
					SRI031041KSK	4
60	M9RD833	1995	110	150	SRI030041KSK	13
					SRI031041KSK	4
61	M9RG832	1995	110	150	SRI030041KSK	13
					SRI031041KSK	4

**RENAULT**

						
	engine	c.c.	kw	hp	SRI part number	pcs
62	M9RK800	1995	127	173	SRI030041KSK	13
					SRI031041KSK	4
63	M9RK802	1995	96 110	131 150	SRI030041KSK	13
					SRI031041KSK	4

**SEAT**

						
	engine	c.c.	kw	hp	SRI part number	pcs
1	AMF	1422	55	75	SRI031063KSK	2
2	AZQ	1198	47	64	SRI030037KSK	7
					SRI031037KSK	15
					SRI032037KSK	4
3	BBM	1198	44	60	SRI032038KSK	5
					SRI034038KSK	2
					SRI030038KSK	13
					SRI031038KSK	10
4	BME	1198	47	64	SRI032038KSK	5
					SRI033038KSK	4
					SRI034038KSK	2
					SRI030037KSK	7
					SRI031037KSK	15
5	BMS	1422	59	80	SRI032037KSK	4
					SRI032038KSK	5
					SRI034038KSK	2
6	BNM	1422	51	69	SRI031063KSK	2
7	BNV	1422	59	80	SRI031063KSK	2
8	BTS	1598	77	105	SRI031054KSK	4
9	BXV	1198	51	69	SRI030037KSK	7
					SRI031037KSK	15
					SRI032037KSK	4
					SRI032038KSK	5
					SRI034038KSK	2
10	BZG	1198	51	69	SRI030037KSK	7
					SRI030054KSK	7
					SRI031037KSK	15
					SRI032037KSK	4
					SRI032038KSK	5
					SRI032054KSK	7
					SRI034038KSK	2
11	CAVA	1390	110	150	SRI031054KSK	4
12	CAVE	1390	132	180	SRI031054KSK	4
13	CAVF	1390	110	150	SRI031054KSK	4
14	CAXA	1390	90	122	SRI031054KSK	4
15	CAXC	1390	92	125	SRI031054KSK	4
					SRI033054KSK	6
					SRI933054KSK	8

**KIT TENDICATENA PER MOTORE**

**TIMING CHAIN KIT PER ENGINE**

<b>SEAT</b>						
engine	c.c.	kw	hp	SRI part number	pcs	
16	CBZA	1197	63	86	SRI032057KSK	7
					SRI030057KSK	6
17	CBZB	1197	77	105	SRI031057KSK	4
					SRI032057KSK	7
18	CFNA	1598	77	105	SRI031054KSK	4
19	CGPA	1198	51	69	SRI032054KSK	7
20	CGPB	1198	44	60	SRI032054KSK	7
21	CGPC	1198	55	75	SRI032054KSK	7
22	CJLB	1198	51	69	SRI032054KSK	7
23	CNKA	1598	60	82	SRI031054KSK	4
24	CNUB	1390	110	150	SRI031054KSK	4
25	CNWB	1390	110	150	SRI031054KSK	4
26	CTHA	1390	110	150	SRI031054KSK	4
27	CTHE	1390	132	180	SRI031054KSK	4
28	CTHF	1390	110	150	SRI031054KSK	4
29	CTJB	1390	110	150	SRI031054KSK	4
30	CTJC	1390	132	180	SRI031054KSK	4

<b>SKODA</b>						
engine	c.c.	kw	hp	SRI part number	pcs	
7	BME	1198	47	64	SRI030037KSK	7
					SRI031037KSK	15
					SRI032037KSK	4
					SRI032038KSK	5
					SRI034038KSK	2
8	BMS	1422	59	80	SRI031063KSK	2
9	BNM	1422	51	69	SRI031063KSK	2
10	BNV	1422	59	80	SRI031063KSK	2
11	BTS	1598	77	105	SRI031054KSK	4
12	BZG	1198	51	69	SRI030037KSK	7
					SRI031037KSK	15
					SRI032037KSK	4
					SRI032038KSK	5
					SRI034038KSK	2
13	CAXA	1390	90	122	SRI031054KSK	4
					SRI033054KSK	6
					SRI933054KSK	8
14	CAXC	1390	92	125	SRI031054KSK	4
					SRI033054KSK	6
					SRI933054KSK	8
15	CBZA	1197	63	86	SRI030057KSK	6
					SRI031057KSK	4
16	CBZB	1197	77	105	SRI032057KSK	7
					SRI030057KSK	6
17	CEVA	1198	51	69	SRI031057KSK	4
					SRI032057KSK	7
					SRI030037KSK	7
					SRI031037KSK	15
					SRI032037KSK	4
18	CFNA	1598	77	105	SRI032038KSK	5
					SRI034038KSK	2
19	CGPA	1198	51	69	SRI031054KSK	4
20	CGPB	1198	51	69	SRI032054KSK	7
21	CGPC	1198	44	60	SRI032054KSK	7
22	CGPB	1198	44	60	SRI032054KSK	7
21	CGPC	1198	55	75	SRI032054KSK	7
22	CHTA	1198	51	69	SRI030054KSK	7

<b>SKODA</b>						
engine	c.c.	kw	hp	SRI part number	pcs	
1	AMF	1422	55	75	SRI031063KSK	2
2	AWY	1198	40	54	SRI030038KSK	13
					SRI031038KSK	10
					SRI032038KSK	5
					SRI033038KSK	4
					SRI034038KSK	2
3	AZQ	1198	47	64	SRI030037KSK	7
					SRI031037KSK	15
					SRI032037KSK	4
					SRI032038KSK	5
					SRI034038KSK	2
4	BBM	1198	44	60	SRI030038KSK	13
					SRI031038KSK	10
					SRI032038KSK	5
					SRI033038KSK	4
					SRI034038KSK	2
5	BLF	1598	85	116	SRI031054KSK	4
6	BMD	1198	40	54	SRI030038KSK	13
					SRI031038KSK	10
					SRI032038KSK	5
					SRI033038KSK	4
					SRI034038KSK	2

**KIT TENDICATENA PER MOTORE**

**TIMING CHAIN KIT PER ENGINE**

SMART										
engine	c.c.	kw	hp	SRI part number	pcs					
1	M132910	999	52 45	71 61	SRI030030KSK	6				
					SRI031030KSK	5				
					SRI032030KSK	4				
2	M132930	999	62 75	84 102	SRI030030KSK	6				
					SRI031030KSK	5				
					SRI032030KSK	4				
3	M160910	599	52	71	SRI030022KSK	12				
					SRI031022KSK	6				
					SRI032022KSK	6				
					SRI033022KSK	4				
	698	37 55	50 75	SRI030022KSK	12					
				SRI031022KSK	6					
				SRI032022KSK	6					
				SRI033022KSK	4					
				4	M160920	599	33 52	45 71	SRI030022KSK	12
									SRI031022KSK	6
SRI032022KSK	6									
SRI033022KSK	4									
698	37 55	50 75	SRI030022KSK	12						
			SRI031022KSK	6						
			SRI032022KSK	6						
			SRI033022KSK	4						
			5	M160921	698	45	61	SRI030022KSK	12	
								SRI031022KSK	6	
SRI032022KSK	6									
SRI033022KSK	4									
60	82	SRI030022KSK		12						
		SRI031022KSK		6						
		SRI032022KSK		6						
SRI033022KSK	4									
6	M160922	698	45	61	SRI030022KSK	12				
					SRI031022KSK	6				
					SRI032022KSK	6				
					SRI033022KSK	4				
	60	82	SRI030022KSK	12						
			SRI031022KSK	6						
			SRI032022KSK	6						
			SRI033022KSK	4						

SMART						
engine	c.c.	kw	hp	SRI part number	pcs	
7	M160923	698	74	101	SRI030022KSK	12
					SRI031022KSK	6
					SRI032022KSK	6
					SRI033022KSK	4
8	M160E6ALB03	599	40	54	SRI030022KSK	12
					SRI031022KSK	6
					SRI032022KSK	6
					SRI033022KSK	4
9	M160E6ALB04	599	33	45	SRI030022KSK	12
					SRI031022KSK	6
					SRI032022KSK	6
					SRI033022KSK	4
10	M160E6ALB05	599	45	61	SRI030022KSK	12
					SRI031022KSK	6
					SRI032022KSK	6
					SRI033022KSK	4
11	OM639939	1493	50 70	68 95	SRI031079KSK	4
12	OM660940	799	30	41	SRI030029KSK	12
					SRI031029KSK	7
					SRI032029KSK	4
					SRI033029KSK	6
					SRI034029KSK	4
13	OM660950	799	33	45	SRI030029KSK	12
					SRI031029KSK	7
					SRI032029KSK	4
					SRI033029KSK	6
					SRI034029KSK	4
14	OM660951	799	40	54	SRI030029KSK	12
					SRI031029KSK	7
					SRI032029KSK	4
					SRI034029KSK	4
15	OM660DE8LA	799	30	41	SRI030029KSK	12
					SRI031029KSK	7
					SRI032029KSK	4
					SRI033029KSK	6
					SRI034029KSK	4



**KIT TENDICATENA PER MOTORE**





**TIMING CHAIN KIT PER ENGINE**





<b>SUZUKI</b>						
engine	c.c.	kw	hp	SRI part number	pcs	
1	D13A	1248	55	75	SRI00030KSK	15
					SRI030075KSK	8
					SRI030100KSK	9
					SRI031000KSK	25
					SRI031001KSK	26
					SRI03100PKSK	16
					SRI032000KSK	6
					SRI033000KSK	4
					SRI034000KSK	9
					SRI030025KSK	6
2	M13A	1328	66 68	90 92	SRI030025KSK	4
					SRI031025KSK	6
3	M15A	1490	73 82	99 112	SRI030025KSK	4
					SRI031025KSK	6
4	M16A	1586	76 92	103 125	SRI030025KSK	4
					SRI031025KSK	6
5	M18A	1796	92	125	SRI030025KSK	4
					SRI031025KSK	6
6	Z10XEP	998	44	60	SRI030024KSK	12
					SRI031024KSK	5
7	Z12XEP	1229	59	80	SRI030024KSK	12
					SRI031024KSK	5
8	Z13DT	1248	51	69	SRI00030KSK	15
					SRI030075KSK	8
					SRI030100KSK	9
					SRI031000KSK	25
					SRI031001KSK	26
					SRI03100PKSK	16
					SRI032000KSK	6
					SRI033000KSK	4
					SRI034000KSK	9
					SRI00030KSK	15
9	Z13DTJ	1248	55	75	SRI00030KSK	8
					SRI030075KSK	9
					SRI030100KSK	25
					SRI031000KSK	26
					SRI03100PKSK	16
					SRI032000KSK	6
					SRI033000KSK	4
					SRI034000KSK	9
					SRI00030KSK	15
					SRI030075KSK	8

<b>TOYOTA</b>						
engine	c.c.	kw	hp	SRI part number	pcs	
1	1KRFE	998	49 52	67 71	SRI030017KSK	7
					SRI031017KSK	4
					SRI930017KSK	8
2	1NDTV	1364	55 66	75 90	SRI030013KSK	5
3	1SZFE	998	48 50	65 68	SRI030012KSK	8
					SRI031012KSK	4
					SRI930012KSK	9
4	1ZZFE	1794	95 99	129 135	SRI030007KSK	8
					SRI031007KSK	4
					SRI032007KSK	7
					SRI930007KSK	8
					SRI030026KSK	8
5	2SZFE	1296	64	87	SRI031026KSK	5
					SRI030007KSK	8
6	3ZZFE	1598	80	109	SRI031007KSK	4
					SRI032007KSK	7
					SRI930007KSK	8
					SRI030007KSK	8
7	4ZZFE	1398	71	97	SRI031007KSK	4
					SRI032007KSK	7
					SRI930007KSK	8
					SRI030007KSK	8
<b>VAUXHALL</b>						
engine	c.c.	kw	hp	SRI part number	pcs	
1	A10XEP	998	44 48	60 65	SRI031070KSK	5
2	A12XEL	1229	51	69	SRI031070KSK	5
3	A12XER	1229	63	86	SRI031070KSK	5
4	A13DTC	1248	55	75	SRI00030KSK	15
					SRI030075KSK	8
					SRI030100KSK	9
					SRI031000KSK	25
					SRI031001KSK	26
					SRI03100PKSK	16
					SRI032000KSK	6
					SRI033000KSK	4
					SRI034000KSK	9
					SRI00030KSK	15

**KIT TENDICATENA PER MOTORE**

**TIMING CHAIN KIT PER ENGINE**

VAUXHALL						
						
engine	c.c.	kw	hp	SRI part number	pcs	
5	A13DTE	1248	70	95	SRI00030KSK	15
					SRI030075KSK	8
					SRI030100KSK	9
					SRI031000KSK	25
					SRI031001KSK	26
					SRI03100PKSK	16
					SRI032000KSK	6
					SRI033000KSK	4
					SRI034000KSK	9
					6	A13DTR
SRI030075KSK	8					
SRI030100KSK	9					
SRI031000KSK	25					
SRI031001KSK	26					
SRI03100PKSK	16					
SRI032000KSK	6					
SRI033000KSK	4					
SRI034000KSK	9					
7	A13FD	1248	66	90		
					SRI030075KSK	8
					SRI030100KSK	9
					SRI031000KSK	25
					SRI031001KSK	26
					SRI03100PKSK	16
					SRI032000KSK	6
					SRI033000KSK	4
					SRI034000KSK	9
8	A14NEL	1364	88	120	SRI031070KSK	5
9	A14NET	1364	103	140	SRI031070KSK	5
10	A14XEL	1398	64	87	SRI031070KSK	5
11	A14XER	1398	74	101	SRI031070KSK	5
12	A14XFL	1398	55	75	SRI031070KSK	5
13	A20NFT	1998	184 206	250 280	SRI032058KSK	7
14	A20NHT	1998	162	220	SRI032058KSK	7
15	A24XE	2384	123	167	SRI032058KSK	7
16	A24XELE9	2384	123	167	SRI032058KSK	7
17	B12XEL	1229	51	69	SRI031070KSK	5
18	B14NEH	1364	110	150	SRI031070KSK	5

VAUXHALL						
						
engine	c.c.	kw	hp	SRI part number	pcs	
19	B14NEHLUJ	1398	103	140	SRI031070KSK	5
20	B14NEL	1364	74 88	101 120	SRI031070KSK	5
21	B14NELLUH	1364	88	120	SRI031070KSK	5
22	B14NET	1364	103 110	140 150	SRI031070KSK	5
23	B14NETLUJ	1364	105	143	SRI031070KSK	5
24	B14XEJ	1398	55	75	SRI031070KSK	5
25	B14XEL	1398	66	90	SRI031070KSK	5
26	B14XER	1398	74	101	SRI031070KSK	5
27	B14XERLDD	1398	64 74	87 101	SRI031070KSK	5
28	B20NFT	1998	206	280	SRI032058KSK	7
29	M9R630	1995	66 84	90 114	SRI031041KSK	4
30	M9R692	1995	84	114	SRI031041KSK	4
31	M9R780	1995	66 84	90 114	SRI031041KSK	4
32	M9R782	1995	66	90	SRI031041KSK	4
33	M9R784	1995	84	114	SRI031041KSK	4
34	M9R786	1995	66 84	90 114	SRI031041KSK	4
35	M9R788	1995	84	114	SRI031041KSK	4
36	X10XE	973	40	54	SRI030024KSK	12
					SRI031024KSK	5
37	X12XE	1199	48	65	SRI030024KSK	12
					SRI031024KSK	5
					SRI030048KSK	17
38	X20DTH	1995	74	101	SRI031048KSK	4
					SRI032048KSK	4
					SRI033048KSK	8
					SRI030048KSK	17
39	X20DTL	1995	60	82	SRI031048KSK	4
					SRI032048KSK	4
					SRI033048KSK	8
					SRI030048KSK	17
40	X22DTH	2171	85	116	SRI031048KSK	4
					SRI032048KSK	4
					SRI033048KSK	8
41	Y13DT	1248	51	69	SRI030100KSK	9

**KIT TENDICATENA PER MOTORE**

**TIMING CHAIN KIT PER ENGINE**

VAUXHALL						
engine	c.c.	kw	hp	SRI part number	pcs	
42	Y20DTH	1995	74	101	SRI030048KSK	17
					SRI031048KSK	4
					SRI032048KSK	4
					SRI033048KSK	8
43	Y20DTL	1995	60	82	SRI030048KSK	17
					SRI031048KSK	4
					SRI032048KSK	4
					SRI033048KSK	8
44	Y22DTH	2172	85 88	116 120	SRI031048KSK	4
					SRI032048KSK	4
					SRI033048KSK	8
45	Y22DTR	2172	92	125	SRI030048KSK	17
					SRI031048KSK	4
					SRI032048KSK	4
					SRI033048KSK	8
46	Z10XE	973	43	58	SRI030024KSK	12
					SRI031024KSK	5
47	Z10XEP	998	44	60	SRI030024KSK	12
					SRI031024KSK	5
48	Z12XE	1199	55	75	SRI030024KSK	12
					SRI031024KSK	5
49	Z12XEP	1229	59	80	SRI030024KSK	12
					SRI030070KSK	10
					SRI031024KSK	5
					SRI031070KSK	5
					SRI932070KSK	12
50	Z13DT	1248	51	69	SRI000030KSK	15
					SRI030075KSK	8
					SRI030100KSK	9
					SRI031000KSK	25
					SRI031001KSK	26
					SRI03100PKSK	16
					SRI032000KSK	6
					SRI033000KSK	4
					SRI034000KSK	9

VAUXHALL						
engine	c.c.	kw	hp	SRI part number	pcs	
51	Z13DTE	1248	70	95	SRI000030KSK	15
					SRI030075KSK	8
					SRI030100KSK	9
					SRI031000KSK	25
					SRI031001KSK	26
					SRI03100PKSK	16
52	Z13DTH	1248	66	90	SRI032000KSK	6
					SRI033000KSK	4
					SRI034000KSK	9
					SRI000030KSK	15
					SRI030075KSK	8
					SRI030100KSK	9
53	Z13DTJ	1248	55	75	SRI031000KSK	25
					SRI031001KSK	26
					SRI03100PKSK	16
					SRI032000KSK	6
					SRI033000KSK	4
					SRI034000KSK	9
54	Z14XEL	1364	55	75	SRI000030KSK	15
					SRI030075KSK	8
					SRI030100KSK	9
55	Z14XEP	1364	66	90	SRI030024KSK	12
					SRI030070KSK	10
					SRI031024KSK	5
					SRI031070KSK	5
56	Z20NET	1998	129	175	SRI031045KSK	5
					SRI031058KSK	6

**KIT TENDICATENA PER MOTORE**

**TIMING CHAIN KIT PER ENGINE**

<b>VAUXHALL</b>						
engine	c.c.	kw	hp	SRI part number	pcs	
57	Z22SE	2198	108	147	SRI030058KSK	17
					SRI030065KSK	16
					SRI031045KSK	5
					SRI031058KSK	6
					SRI031065KSK	13
					SRI032065KSK	14
					SRI030045KSK	17
58	Z22YH	2198	110 114	150 155	SRI030065KSK	16
					SRI031045KSK	5
					SRI031058KSK	6
					SRI031065KSK	13
					SRI032065KSK	14

<b>VOLKSWAGEN</b>						
engine	c.c.	kw	hp	SRI part number	pcs	
9	BBM	1198	44	60	SRI030038KSK	13
					SRI031038KSK	10
					SRI032038KSK	5
					SRI033038KSK	4
					SRI034038KSK	2
					SRI031054KSK	4
10	BKG	1390	66	90	SRI031054KSK	4
11	BLF	1598	85	116	SRI031054KSK	4
12	BLG	1390	125	170	SRI031054KSK	4
13	BLN	1390	66	90	SRI031054KSK	4
14	BLP	1598	85	116	SRI031054KSK	4
15	BMD	1198	40	54	SRI030038KSK	13
					SRI031038KSK	10
					SRI032038KSK	5
					SRI033038KSK	4
					SRI034038KSK	2
					SRI030037KSK	7
16	BME	1198	47	64	SRI031037KSK	11
					SRI032037KSK	4
					SRI032038KSK	5
					SRI034038KSK	2
					SRI031063KSK	2
					SRI031054KSK	4
17	BMS	1422	59	80	SRI031063KSK	2
18	BMV	1390	103	140	SRI031054KSK	4
19	BNM	1422	51	69	SRI031063KSK	2
20	BNV	1422	59	80	SRI031063KSK	2
21	BTS	1598	77	105	SRI031054KSK	4
22	BWB	1422	51	69	SRI031063KSK	2
23	BWK	1390	110	150	SRI031054KSK	4
24	BZG	1198	51	69	SRI030037KSK	7
					SRI030054KSK	7
					SRI031037KSK	15
					SRI032037KSK	4
					SRI032038KSK	5
					SRI034038KSK	2
25	CAVA	1390	110	150	SRI031054KSK	4
26	CAVC	1390	103	140	SRI031054KSK	4
27	CAVD	1390	118	160	SRI031054KSK	4
28	CAVE	1390	132	180	SRI031054KSK	4

<b>VOLVO</b>						
engine	c.c.	kw	hp	SRI part number	pcs	
1	D4164T	1560	80	109	SRI030047KSK	2
2	D4204T	1998	100	136	SRI030059KSK	3
3	D4204T2	1998	98	133	SRI030059KSK	3

<b>VOLKSWAGEN</b>						
engine	c.c.	kw	hp	SRI part number	pcs	
1	AMF	1422	55	75	SRI031063KSK	2
2	ANY	1191	45	61	SRI031063KSK	2
3	AWY	1198	40	54	SRI030038KSK	13
					SRI031038KSK	10
					SRI032038KSK	5
					SRI033038KSK	4
					SRI034038KSK	2
4	AXU	1390	63	86	SRI031054KSK	4
5	AYZ	1191	45	61	SRI031063KSK	2
6	AZQ	1198	47	64	SRI030037KSK	7
					SRI031037KSK	15
					SRI032037KSK	4
					SRI032038KSK	5
					SRI034038KSK	2
7	BAG	1598	85	116	SRI031054KSK	4
8	BAY	1422	55	75	SRI031063KSK	2

**KIT TENDICATENA PER MOTORE**

**TIMING CHAIN KIT PER ENGINE**

<b>VOLKSWAGEN</b>						
engine	c.c.	kw	hp	SRI part number	pcs	
29	CAXA	1390	90	122	SRI031054KSK	4
					SRI033054KSK	6
					SRI933054KSK	8
30	CBZA	1197	63	86	SRI030057KSK	6
					SRI031057KSK	4
					SRI032057KSK	7
31	CBZB	1197	77	105	SRI030057KSK	6
					SRI031057KSK	4
					SRI032057KSK	7
32	CBZC	1197	66	90	SRI030057KSK	6
					SRI031057KSK	4
					SRI032057KSK	7
33	CDDA	1390	63	86	SRI031054KSK	4
34	CDGA	1390	110	150	SRI031054KSK	4
35	CFNA	1598	77	105	SRI031054KSK	4
36	CFNB	1598	63	86	SRI031054KSK	4
37	CGPA	1198	51	69	SRI032054KSK	7
38	CGPB	1198	44	60	SRI032054KSK	7
39	CHFA	1198	44	60	SRI030038KSK	13
					SRI031038KSK	10
					SRI032038KSK	5
					SRI033038KSK	4
					SRI034038KSK	2
40	CHFB	1198	40	54	SRI030038KSK	13
					SRI031038KSK	10
					SRI032038KSK	5
					SRI033038KSK	4
					SRI034038KSK	2
41	CJLA	1198	55	75	SRI032054KSK	7
42	CKMA	1390	118	160	SRI031054KSK	4
43	CLPA	1390	63	86	SRI031054KSK	4
44	CLRA	1595	77	105	SRI031054KSK	4
45	CLSA	1598	77	105	SRI031054KSK	4
46	CMSB	1390	90	122	SRI031054KSK	4
					SRI033054KSK	6
					SRI933054KSK	8
47	CNKA	1598	60	82	SRI031054KSK	4
48	CNWA	1390	118	160	SRI031054KSK	4
49	CTHA	1390	110	150	SRI031054KSK	4

<b>VOLKSWAGEN</b>						
engine	c.c.	kw	hp	SRI part number	pcs	
50	CTHB	1390	125	170	SRI031054KSK	4
51	CTHC	1390	103	140	SRI031054KSK	4
52	CTHD	1390	118	160	SRI031054KSK	4
53	CTHE	1390	132	180	SRI031054KSK	4
54	CTKA	1390	118	160	SRI031054KSK	4



**KIT TENDICATENA**  
***TIMING CHAIN KIT***

Questo catalogo contiene dati ed informazioni provenienti dalla pluriennale esperienza di Finimpianti. Tuttavia non possiamo assumere alcuna responsabilità per eventuali dati errati od incompleti.

Tutti i dati e le informazioni contenute nel presente catalogo sono fornite a puro scopo informativo e senza responsabilità e non potranno dare adito ad alcuna forma di risarcimento.

Visto il continuo sviluppo dei nostri prodotti, Finimpianti si riserva il diritto di apportare modifiche senza preavviso.

Denominazioni, numeri e codici originali sono riportati a puro titolo di riferimento.

*All the information and data contained in this catalogue came from the long Finimpianti experience. Nevertheless we can not assume any responsibility for possible mistakes.*

*All the information and data contained in this catalogue are provide "as is" without any representation or warranty express or implied. Under no circumstances whatsoever shall Finimpianti be liable for any damages whatsoever arising out of the use of the information and data contained in this catalogue.*

*Finimpianti does not warrant the accuracy or completeness of the materials and content contained in this catalogue and reserves the right to correct any errors or omissions at any time without notice and without obligation to the users of this catalogue.*



**KIT TENDICATENA**

**TIMING CHAIN KIT**

**SRI000030KSK**

15 pcs



composizione :	q.ty	composition:
CATENA DI DISTRIBUZIONE	1	TIMING CHAIN
INGRANAGGIO	2	GEAR
TENDICATENA	1	TENSIONER
PATTINO TENDICATENA DX	1	RIGHT GUIDE
PATTINO TENDICATENA SX	1	LEFT GUIDE
GUARNIZIONE POMPA OLIO	1	OIL PUMP GASKET

adattabile a: suitable for :	motore: engine :	
ALFA ROMEO	199A3000 199B1000 199B4000	199B8000 330A1000
CHEVROLET	A13DTC	A13DTELSF
CITROËN	FHYF13DTE6	FHZF13DTE5
FIAT	169A1000 169A5000 188A8000 188A9000 199A2000 199A3000 199A9000 199B1000 199B2000 199B4000 199B8000	223A9000 225A2000 263A2000 263A6000 312A8000 312B1000 312B2000 330A1000 55266963 955B2000
FORD	FD4	
LANCIA	188A9000 199A2000 199A3000 199A9000	199B1000 312B1000 312B5000
OPEL	A13DTC A13DTE A13DTR A13FD	Z13DT Z13DTE Z13DTH Z13DTJ
PEUGEOT	199A9000	FHYF13DTE6 FHZF13DTE5
SUZUKI	D13A	Z13DT Z13DTJ
VAUXHALL	A13DTC A13DTE A13DTR A13FD	Z13DT Z13DTE Z13DTH Z13DTJ

**SRI030002KSK**

18 pcs

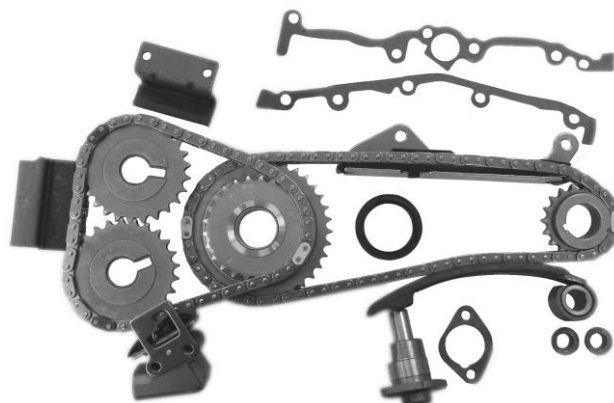

composizione :	q.ty	composition:
CATENA DI DISTRIBUZIONE INF.	1	LOWER TIMING CHAIN
CATENA DI DISTRIBUZIONE SUP.	1	UPPER TIMING CHAIN
INGRANAGGIO	4	GEAR
TENDICATENA INF.	1	LOWER TENSIONER
TENDICATENA SUP	1	UPPER TENSIONER
PATTINO TENDICATENA DX	1	RIGHT GUIDE
PATTINO TENDICATENA SX	1	LEFT GUIDE
GUIDA CATENA	1	GUIDE
GUARNIZIONE	1	GASKET
PARAOILIO ALBERO MOTORE	1	CRANK SHAFT OIL SEAL

adattabile a: suitable for :	motore: engine :	
NISSAN	GA14DE GA14DS	GA16DE GA16DS

**SRI030004KSK**

11 pcs



composizione :	q.ty	composition:
CATENA DI DISTRIBUZIONE INF.	1	LOWER TIMING CHAIN
CATENA DI DISTRIBUZIONE SUP.	1	UPPER TIMING CHAIN
INGRANAGGIO	4	GEAR
TENDICATENA INF.	1	LOWER TENSIONER
TENDICATENA SUP	1	UPPER TENSIONER
PATTINO TENDICATENA DX	1	RIGHT GUIDE
PATTINO TENDICATENA SX	1	LEFT GUIDE
PARAOILIO ALBERO MOTORE	1	CRANK SHAFT OIL SEAL

adattabile a: suitable for :	motore: engine :	
NISSAN	CG10DE	CG13DE

**KIT TENDICATENA**

**TIMING CHAIN KIT**

**SRI030005KSK**

7 pcs



composizione :	q.ty	composition:
CATENA DI DISTRIBUZIONE	1	TIMING CHAIN
INGRANAGGIO	2	GEAR
TENDICATENA	1	TENSIONER
PATTINO TENDICATENA DX	1	RIGHT GUIDE
PATTINO TENDICATENA SX	1	LEFT GUIDE
PARAOLIO ALBERO MOTORE	1	CRANK SHAFT OIL SEAL

adattabile a: suitable for :	motore: engine :
NISSAN	CG10DE

**SRI030012KSK**

8 pcs



composizione :	q.ty	composition:
CATENA DI DISTRIBUZIONE	1	TIMING CHAIN
INGRANAGGIO	2	GEAR
TENDICATENA	1	TENSIONER
PATTINO TENDICATENA DX	1	RIGHT GUIDE
PATTINO TENDICATENA SX	1	LEFT GUIDE
GUIDA CATENA	1	GUIDE
PARAOLIO ALBERO MOTORE	1	CRANK SHAFT OIL SEAL

adattabile a: suitable for :	motore: engine :
TOYOTA	1SZFE

**SRI030007KSK**

8 pcs



composizione :	q.ty	composition:
CATENA DI DISTRIBUZIONE	1	TIMING CHAIN
INGRANAGGIO	3	GEAR
TENDICATENA	1	TENSIONER
PATTINO TENDICATENA	2	GUIDE
PARAOLIO ALBERO MOTORE	1	CRANK SHAFT OIL SEAL

adattabile a: suitable for :	motore: engine :
TOYOTA	1ZZFE 3ZZFE 4ZZFE

**SRI030013KSK**

5 pcs



composizione :	q.ty	composition:
CATENA DI DISTRIBUZIONE	1	TIMING CHAIN
TENDICATENA	1	TENSIONER
PATTINO TENDICATENA DX	1	RIGHT GUIDE
PATTINO TENDICATENA SX	1	LEFT GUIDE
PARAOLIO ALBERO MOTORE	1	CRANK SHAFT OIL SEAL

adattabile a: suitable for :	motore: engine :
MINI	1ND 1NDTV
TOYOTA	1NDTV

**KIT TENDICATENA**

**TIMING CHAIN KIT**

**SRI030017KSK**

7 pcs



composizione :	q.ty	composition:
CATENA DI DISTRIBUZIONE	1	TIMING CHAIN
INGRANAGGIO	2	GEAR
TENDICATENA	1	TENSIONER
PATTINO TENDICATENA DX	1	RIGHT GUIDE
PATTINO TENDICATENA SX	1	LEFT GUIDE
PARAOILIO ALBERO MOTORE	1	CRANK SHAFT OIL SEAL

adattabile a: suitable for :	motore: engine :	
CITROËN	1KRFE	
DAIHATSU	1KRFE	
PEUGEOT	1KR384F 384F	CFA384F
TOYOTA	1KRFE	

**SRI030022KSK**

12 pcs

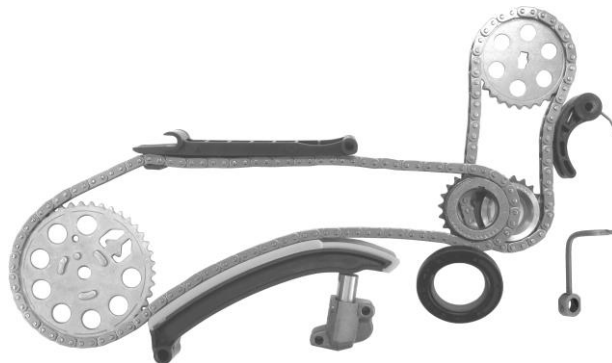

composizione :	q.ty	composition:
CATENA DI DISTRIBUZIONE	1	TIMING CHAIN
CATENA POMPA OLIO	1	OIL PUMP CHAIN
INGRANAGGIO	4	GEAR
PATTINO TENDICATENA DX	1	RIGHT GUIDE
PATTINO TENDICATENA SX	1	LEFT GUIDE
PATTINO	1	GUIDE
TENDICATENA	1	TENSIONER
PARAOILIO ALBERO MOTORE	1	CRANK SHAFT OIL SEAL
TUBETTO LUBRIFICAZIONE OLIO	1	OIL FEED PIPE

adattabile a: suitable for :	motore: engine :	
SMART	M160910 M160920 M160921 M160922	M160923 M160E6ALB03 M160E6ALB04 M160E6ALB05

**SRI030019KSK**

10 pcs



composizione :	q.ty	composition:
CATENA DI DISTRIBUZIONE	1	TIMING CHAIN
INGRANAGGIO	5	GEAR
TENDICATENA	1	TENSIONER
PATTINO TENDICATENA DX	1	RIGHT GUIDE
PATTINO TENDICATENA SX	1	LEFT GUIDE
PARAOILIO ALBERO MOTORE	1	CRANK SHAFT OIL SEAL

adattabile a: suitable for :	motore: engine :
MITSUBISHI	4M41

**SRI030024KSK**

12 pcs

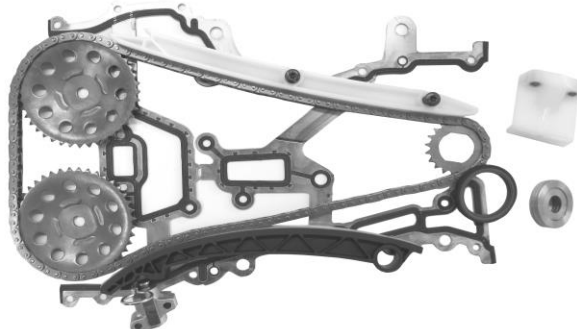

composizione :	q.ty	composition:
CATENA DI DISTRIBUZIONE	1	TIMING CHAIN
INGRANAGGIO	3	GEAR
PATTINO TENDICATENA DX	1	RIGHT GUIDE
PATTINO TENDICATENA SX	1	LEFT GUIDE
PATTINO	1	GUIDE
TENDICATENA	1	TENSIONER
GUARNIZIONE POMPA OLIO	1	OIL PUMP GASKET
PARAOILIO ALBERO MOTORE	1	CRANK SHAFT OIL SEAL
RONDELLE	2	WASHERS

adattabile a: suitable for :	motore: engine :	
OPEL	X10XE X12XE Z10XE Z10XEP	Z12XE Z12XEP Z14XEP
SUZUKI	Z10XEP	Z12XEP
VAUXHALL	X10XE X12XE Z10XE Z10XEP	Z12XE Z12XEP Z14XEP

**KIT TENDICATENA**

**TIMING CHAIN KIT**

**SRI030025KSK**

6 pcs

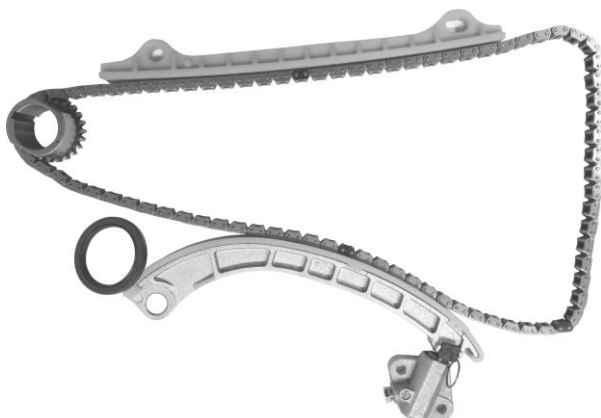

composizione :	q.ty	composition:
CATENA DI DISTRIBUZIONE	1	TIMING CHAIN
INGRANAGGIO	1	GEAR
TENDICATENA	1	TENSIONER
PATTINO TENDICATENA DX	1	RIGHT GUIDE
PATTINO TENDICATENA SX	1	LEFT GUIDE
PARAOLIO ALBERO MOTORE	1	CRANK SHAFT OIL SEAL

adattabile a: suitable for :	motore: engine :	
FIAT	M16A	
SUZUKI	M13A M15A	M16A M18A

**SRI030029KSK**

12 pcs



composizione :	q.ty	composition:
CATENA DI DISTRIBUZIONE	1	TIMING CHAIN
INGRANAGGIO	4	GEAR
PATTINO TENDICATENA DX	1	RIGHT GUIDE
PATTINO TENDICATENA SX	1	LEFT GUIDE
CATENA POMPA OLIO	1	OIL PUMP CHAIN
GUIDA TENDICATENA	1	TENSIONER GUIDE
TENDICATENA	1	TENSIONER
PARAOLIO ALBERO MOTORE	1	CRANK SHAFT OIL SEAL
MOLLA	1	SPRING

adattabile a: suitable for :	motore: engine :	
SMART	OM660940 OM660950	OM660951 OM660DE8LA

**SRI030026KSK**

8 pcs



composizione :	q.ty	composition:
CATENA DI DISTRIBUZIONE	1	TIMING CHAIN
INGRANAGGIO	2	GEAR
TENDICATENA	1	TENSIONER
PATTINO TENDICATENA	2	GUIDE
GUIDA	1	GUIDE
PARAOLIO ALBERO MOTORE	1	CRANK SHAFT OIL SEAL

adattabile a: suitable for :	motore: engine :	
TOYOTA	2SZFE	

**SRI030030KSK**

6 pcs



composizione :	q.ty	composition:
CATENA DI DISTRIBUZIONE	1	TIMING CHAIN
INGRANAGGIO	1	GEAR
TENDICATENA	1	TENSIONER
PATTINO TENDICATENA DX	1	RIGHT GUIDE
PATTINO TENDICATENA SX	1	LEFT GUIDE
PARAOLIO ALBERO MOTORE	1	CRANK SHAFT OIL SEAL

adattabile a: suitable for :	motore: engine :	
SMART	M132910	M132930

**KIT TENDICATENA**

**TIMING CHAIN KIT**

**SRI030037KSK**

7 pcs



composizione :	q.ty	composition:
CATENA DI DISTRIBUZIONE	1	TIMING CHAIN
TENDICATENA	1	TENSIONER
PATTINO TENDICATENA DX	1	RIGHT GUIDE
PATTINO TENDICATENA SX	1	LEFT GUIDE
INGRANAGGIO	3	GEAR

adattabile a: suitable for :	motore: engine :	
SEAT	AZQ BME	BXV BZG
SKODA	AZQ BME	BZG CEVA
VOLKSWAGEN	AZQ BME	BZG

**SRI030038KSK**

13 pcs



composizione :	q.ty	composition:
CATENA DI DISTRIBUZIONE	1	TIMING CHAIN
CATENA POMPA OLIO	1	OIL PUMP CHAIN
INGRANAGGIO	4	GEAR
PATTINO TENDICATENA DX	1	RIGHT GUIDE
PATTINO TENDICATENA SX	1	LEFT GUIDE
TENDICATENA	2	TENSIONER
PARAOLIO ALBERO MOTORE	1	CRANK SHAFT OIL SEAL
VITI BULLONI	2	SCREWS BOLTS

adattabile a: suitable for :	motore: engine :	
SEAT	BBM	
SKODA	AWY BBM	BMD
VOLKSWAGEN	AWY BBM BMD	CHFA CHFB

**SRI030041KSK**

13 pcs



composizione :	q.ty	composition:
CATENA DI DISTRIBUZIONE	1	TIMING CHAIN
INGRANAGGIO	2	GEAR
PATTINO TENDICATENA DX	1	RIGHT GUIDE
PATTINO TENDICATENA SX	1	LEFT GUIDE
TENDICATENA	1	TENSIONER
PARAOLIO ALBERO MOTORE	1	CRANK SHAFT OIL SEAL
VITI BULLONI	6	SCREWS BOLTS

adattabile a: suitable for :	motore: engine :			
NISSAN	M9R M9R630A6 M9R692F6 M9R760	M9R780 M9R782 M9R786M7		
	OPEL	M9R630 M9R692 M9R780 M9R782	M9R784 M9R786 M9R788	
		RENAULT	M9R610 M9R615 M9R630 M9R692 M9R700 M9R721 M9R722 M9R724 M9R740 M9R742 M9R744 M9R750 M9R756 M9R760 M9R761 M9R762 M9R763 M9R780 M9R782 M9R784 M9R786 M9R800 M9R802 M9R804 M9R805 M9R806 M9R808 M9R809 M9R811 M9R812K8 M9R814	M9R815 M9R816 M9R817 M9R820 M9R824 M9R830 M9R832 M9R834V8 M9R83528 M9R836H8 M9R839 M9R844 M9R845 M9R846 M9R849 M9R855 M9R856 M9R857 M9R858 M9R859 M9R862 M9R864 M9R865 M9R866 M9R8700 M9RA742 M9RD833 M9RC832 M9RK800 M9RK802

**KIT TENDICATENA**

**TIMING CHAIN KIT**

**SRI030042KSK**

7 pcs



composizione :	q.ty	composition:
CATENA DI DISTRIBUZIONE INF.	1	LOWER TIMING CHAIN
CATENA DI DISTRIBUZIONE SUP.	1	UPPER TIMING CHAIN
PATTINO TENDICATENA SUP.DX	1	UPPER RIGHT GUIDE
PATTINO TENDICATENA SUP.SX	1	UPPER LEFT GUIDE
PATTINO TENDICATENA INF.DX	1	LOWER RIGHT GUIDE
PATTINO TENDICATENA INF.SX	1	LOWER LEFT GUIDE
TENDICATENA	1	TENSIONER

adattabile a: suitable for :	motore: engine :
BMW	M47D20204D4 M47N204D4 M57306D3 M57D25256D2 M57D30306D2 M57D30306D3 M57D30306D4 M57D30306D5 M57N2306D2 M57N2306D3 M57N306D2 M57N306D5

**SRI030044KSK**

15 pcs



composizione :	q.ty	composition:
CATENA DI DISTRIBUZ. INF.DX.	1	LOWER RIGHT TIMING CHAIN
CATENA DI DISTRIBUZ. INF.SX.	1	LOWER LEFT TIMING CHAIN
CATENA DI DISTRIBUZIONE SUP.	1	UPPER TIMING CHAIN
PATTINO TENDICATENA	6	GUIDE
GUIDA CATENA	1	CHAIN GUIDE
TENDICATENA INF.DX.	1	LOWER RIGHT TENSIONER
TENDICATENA INF.SX.	1	LOWER LEFT TENSIONER
TENDICATENA SUP.	1	UPPER TENSIONER
INGRANAGGIO	2	GEAR

adattabile a: suitable for :	motore: engine :
HYUNDAI	D4CB
KIA	D4CB

**SRI030043KSK**

10 pcs



composizione :	q.ty	composition:
CATENA DI DISTRIBUZIONE INF.	1	LOWER TIMING CHAIN
CATENA DI DISTRIBUZIONE SUP.	1	UPPER TIMING CHAIN
PATTINO TENDICATENA SUP.DX	1	UPPER RIGHT GUIDE
PATTINO TENDICATENA SUP.SX	1	UPPER LEFT GUIDE
PATTINO TENDICATENA INF.DX	1	LOWER RIGHT GUIDE
PATTINO TENDICATENA INF.SX	1	LOWER LEFT GUIDE
TENDICATENA INF.	1	LOWER TENSIONER
TENDICATENA SUP.	1	UPPER TENSIONER
INGRANAGGIO	2	GEAR

adattabile a: suitable for :	motore: engine :
BMW	N47D16A N47D20A N47D20B N47D20C N47D20D
MINI	N47C16A N47C20A

**SRI030045KSK**

17 pcs

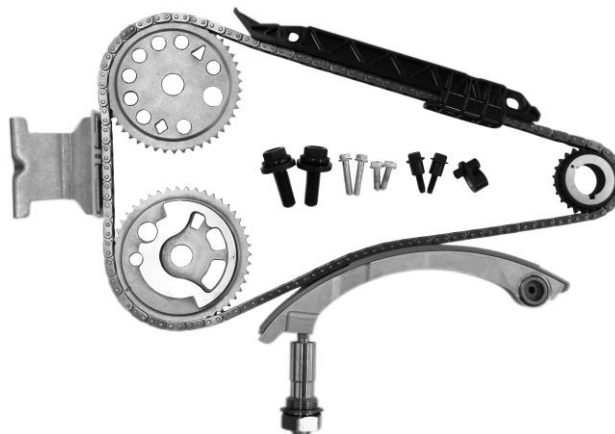

composizione :	q.ty	composition:
CATENA DI DISTRIBUZIONE	1	TIMING CHAIN
INGRANAGGIO	3	GEAR
TENDICATENA	1	TENSIONER
GUIDA CATENA	1	CHAIN GUIDE
VITI BULLONI	8	SCREWS BOLTS
GRUPPO GETTO	1	OIL NOZZLE

adattabile a: suitable for :	motore: engine :
FIAT	194A1000
OPEL	Z22YH
VAUXHALL	Z22YH

**KIT TENDICATENA**

**TIMING CHAIN KIT**

**SRI030046KSK**

7 pcs



composizione :	q.ty	composition:
CATENA DI DISTRIBUZIONE	1	TIMING CHAIN
TENDICATENA	1	TENSIONER
INGRANAGGIO	2	GEAR
GUIDA CATENA	3	CHAIN GUIDE

adattabile a: suitable for :	motore: engine :		
CITROËN	5F04EP6CDT 5FDEP6DTS 5FEPP6CDTMD 5FMPP6CDTM 5FMPP6CDT 5FNEP6CDT 5FNEP6DT	5FREPP6DT 5FSEP6DTS 5FTEP6DT 5FVEP6CDT 5FXEP6DT 5GYEP6FTDM 5GZEP6FDT	
	PEUGEOT	5F02EP6CDT 5F04EP6CDT 5FAEP6CDT 5FEPP6CDTMD 5FMPP6CDTM 5FNEP6CDT 5FREPP6DT 5FTEP6DT 5FVEP6CDT 5FVEP6DT	5FXEP6DT 5FYEP6DTS 5G02EP6FTDM 5G02EP6FTMD 5GXEP6FTMD 5GYEP6FTDM 5GZEP6FDT EP6CDT EP6CDTM5FM EP6FTMD

**SRI030047KSK**

2 pcs



composizione :	q.ty	composition:
CATENA DI DISTRIBUZIONE	1	TIMING CHAIN
PATTINO	1	GUIDE

adattabile a: suitable for :	motore: engine :			
CITROËN	8HYDV4TED4 9H01DV6TED4 9H03DV6AUTED4 9HSDV6TED4BU 9HTDV6BUTED4 9HUDV6UTED4	9HVDV6TED4 9HXDV6ATED4 9HYDV6TED4 9HZDV6TED4 DV6ATED4 DV6B		
	FIAT	9H07DV6UC 9HM 9HU	DV6UC9HM DV6UTED4	
		FORD	G8DA G8DB G8DC G8DD G8DE G8DF GPDA GPDB GPDC HHDA HHDB	HHJA HHJB HHJC HHJD HHJE HHJF MTDA T3JA TZJA TZJB UBJA
			MAZDA	Y601
	MINI		9HZ 9HZDV6TED4	W16D16
PEUGEOT			9H01DV6TED4 9H02DV6B 9HSDV6TED4BU 9HTDV6BUTED4 9HUDV6UTED4 9HVDV6ATED4	9HVDV6TED4 9HWDV6B 9HXDV6ATED4 9HXDV6AUTED4 9HYDV6TED4 9HZDV6TED4
	VOLVO		D4164T	

**SRI030048KSK**

17 pcs

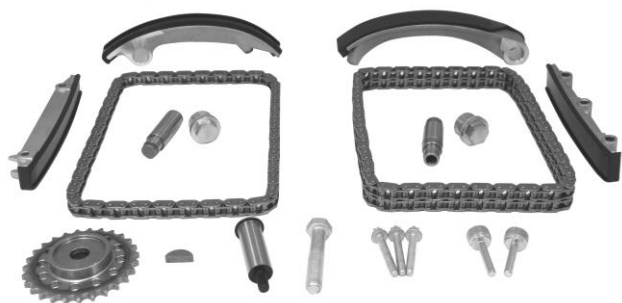

composizione :	q.ty	composition:
CATENA DI DISTRIBUZIONE	2	TIMING CHAIN
INGRANAGGIO	1	GEAR
TENDICATENA	2	TENSIONER
GUIDA CATENA	4	CHAIN GUIDE
VITI BULLONI	7	SCREWS BOLTS
CHIAVETTA	1	KEY SLOT

adattabile a: suitable for :	motore: engine :	
OPEL	X20DTH	Y20DTL
	X20DTL	Y22DTH
	Y20DTH	Y22DTR
VAUXHALL	X20DTH	Y20DTL
	X20DTL	Y22DTH
	Y20DTH	Y22DTR

**SRI030049KSK**

5 pcs



composizione :	q.ty	composition:
CATENA DI DISTRIBUZIONE	2	TIMING CHAIN
INGRANAGGIO	2	GEAR
SLITTA DOPPIA	1	DOUBLE GUIDE

adattabile a: suitable for :	motore: engine :	
FORD	BHDA	P7PB
	BHDB	P9PA
	BHPA	P9PB
	C9DA	P9PC
	C9DB	P9PD
	C9DC	QYBA
	C9DE	QYWA
	F9DA	R2PA
	F9DB	R3PA
	FFBA	RTN
	FFDA	RTP
	FFWA	RTQ
	HCPA	RWPA
	HCPB	RWPC
	KHBA	RWPD
	KKDA	RWPE
	KKDB	RWPF
	P7PA	

**SRI030050KSK**

6 pcs



composizione :	q.ty	composition:
CATENA DI DISTRIBUZIONE	1	TIMING CHAIN
TENDICATENA	1	TENSIONER
GUIDA CATENA	3	CHAIN GUIDE
PARAOILIO ALBERO MOTORE	1	CRANK SHAFT OIL SEAL

adattabile a: suitable for :	motore: engine :	
MERCEDES	OM611961	OM646821
	OM611962	OM646951
	OM611980	OM646961
	OM611981	OM646962
	OM611987	OM646963
	OM612961	OM646966
	OM612962	OM646980
	OM612963	OM646981
	OM612965	OM646982
	OM612966	OM646983
	OM612967	OM646984
	OM612981	OM646985
	OM612990	OM646986
	OM613960	OM646989
	OM613961	OM646990
	OM646811	OM647961
	OM646812	OM648960
	OM646820	OM648961

**SRI030052KSK**

6 pcs



composizione :	q.ty	composition:
CATENA DI DISTRIBUZIONE	1	TIMING CHAIN
TENDICATENA	1	TENSIONER
PATTINO TENDICATENA DX	1	RIGHT GUIDE
PATTINO TENDICATENA SX	1	LEFT GUIDE
INGRANAGGIO	2	GEAR

adattabile a: suitable for :	motore: engine :	
FORD	A9A	BAJA
	A9B	CDB
	A9JA	CDC
	A9JB	CDRB



**KIT TENDICATENA**

**TIMING CHAIN KIT**

**SRI030053KSK**

6 pcs



composizione :	q.ty	composition:
CATENA DI DISTRIBUZIONE	1	TIMING CHAIN
TENDICATENA	1	TENSIONER
GUIDA CATENA	3	CHAIN GUIDE
PARAOILIO ALBERO MOTORE	1	CRANK SHAFT OIL SEAL

adattabile a: suitable for :	motore: engine :	
MERCEDES	M111920	M111957
	M111921	M111958
	M111940	M111960
	M111941	M111961
	M111942	M111970
	M111943	M111973
	M111944	M111974
	M111945	M111975
	M111946	M111977
	M111947	M111978
	M111948	M111979
	M111950	M111980
	M111951	M111981
	M111952	M111982
	M111955	M111983
	M111956	M111984

**SRI030054KSK**

7 pcs

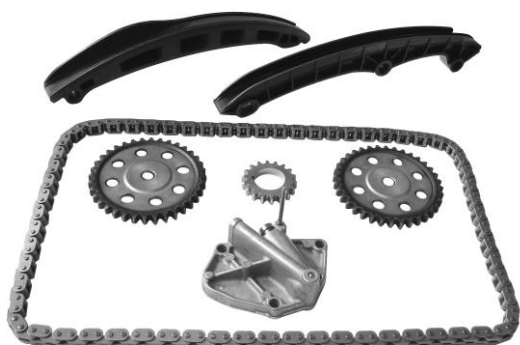

composizione :	q.ty	composition:
CATENA DI DISTRIBUZIONE	1	TIMING CHAIN
TENDICATENA	1	TENSIONER
INGRANAGGIO	3	GEAR
PATTINO TENDICATENA DX	1	RIGHT GUIDE
PATTINO TENDICATENA SX	1	LEFT GUIDE

adattabile a: suitable for :	motore: engine :
SEAT	BZG
SKODA	CHTA
VOLKSWAGEN	BZG

**SRI030055KSK**

6 pcs



composizione :	q.ty	composition:
CATENA DI DISTRIBUZIONE	1	TIMING CHAIN
TENDICATENA	1	TENSIONER
INGRANAGGIO	1	GEAR
GUIDA CATENA	2	CHAIN GUIDE
PARAOILIO ALBERO MOTORE	1	CRANK SHAFT OIL SEAL

adattabile a: suitable for :	motore: engine :	
ALFA ROMEO	199B6000	312A2000
FIAT	199B6000 312A2000 312A4000	312A5000 312A6000 312A7000
LANCIA	312A2000	312A5000

**SRI030056KSK**

8 pcs



composizione :	q.ty	composition:
CATENA DI DISTRIBUZIONE	2	TIMING CHAIN
TENDICATENA	1	TENSIONER
TENDICATENA+PATTINO	1	TENSIONER+GUIDE
PATTINO TENDICATENA	3	GUIDE
PARAOILIO ALBERO MOTORE	1	CRANK SHAFT OIL SEAL

adattabile a: suitable for :	motore: engine :	
MERCEDES	M271921	M271951
	M271940	M271952
	M271941	M271954
	M271942	M271955
	M271944	M271956
	M271946	M271957
	M271948	M271958
	M271950	

**KIT TENDICATENA**

**TIMING CHAIN KIT**

**SRI030057KSK**

6 pcs



composizione :	q.ty	composition:
CATENA DI DISTRIBUZIONE	1	TIMING CHAIN
TENDICATENA	1	TENSIONER
INGRANAGGIO	1	GEAR
PATTINO	1	GUIDE
VITI BULLONI	2	SCREWS BOLTS

adattabile a: suitable for :	motore: engine :
AUDI CBZA	CBZB
SEAT CBZB	
SKODA CBZA	CBZB
VOLKSWAGEN CBZA CBZB	CBZC

**SRI030058KSK**

17 pcs



composizione :	q.ty	composition:
CATENA DI DISTRIBUZIONE	1	TIMING CHAIN
INGRANAGGIO	3	GEAR
TENDICATENA	1	TENSIONER
GUIDA CATENA	3	CHAIN GUIDE
VITI BULLONI	8	SCREWS BOLTS
GRUPPO GETTO	1	OIL NOZZLE

adattabile a: suitable for :	motore: engine :
FIAT 194A1000	
OPEL Z22SE	
VAUXHALL Z22SE	

**SRI030059KSK**

3 pcs



composizione :	q.ty	composition:
CATENA DI DISTRIBUZIONE	1	TIMING CHAIN
GUIDA CATENA	1	CHAIN GUIDE
TENDICATENA	1	TENSIONER

adattabile a: suitable for :	motore: engine :
CITROËN	4HWDW12TED4 AHYDW10CE AHZDW10CD RH01DW10BTED4 RH02DW10CTED4 RHCDW10CTED4 RHDDW10CB RHDDW10CTED4 RHEDW10CTED4 RHFWD10BTED4 RHGDW10UTED4 RHHDW10CTED4 RHJDW10BTED4 RHKDW10UTED4 RHLDW10BTED4 RHRDW10BTED4
FIAT	4HWDW12ATED4 DW10BTED4 DW10UTED4 RH02 RHG RHH RHK RHMDW10ATED4 RHR RHT RHWDW10ATED4
FORD	AZBA AZBC AZWA AZWC G6DA G6DB G6DC G6DD G6DE G6DF G6DG IXDA KLBA KLWA LPBA QXBA QXBB QXWA QXWB QXWC T7DA T7DB T8DA TXBA TXBB TXDA TXDB TXWA TYBA TYDA TYWA UFBA UFBB UFDA UFDB UFWA UKBA UKBB UKDA UKDB UKWA
LANCIA	4HWDW12ATED4 RHKDW10UTED4 RHMDW10ATED4 RHRDW10BTED4 RHT RHWDW10ATED4
PEUGEOT	4HZDW12TED4 AHYDW10CE AHZDW10CD RH01DW10BTED4 RH02DW10CTED4 RHCDW10CTED4 RHDDW10CTED4 RHEDW10CTED4 RHFWD10BTED4 RHGDW10UTED4 RHHDW10CTED4 RHKDW10UTED4 RHLDW10BTED4 RHRDW10BTED4
VOLVO	D4204T D4204T2

**KIT TENDICATENA**

**TIMING CHAIN KIT**

**SRI030061KSK**

4 pcs



composizione :	q.ty	composition:
CATENA DI DISTRIBUZIONE	1	TIMING CHAIN
PATTINO	2	GUIDE
TENDICATENA	1	TENSIONER

adattabile a: suitable for :	motore: engine :
BMW	M43B16164E2 M43B16164E3
	M43B18184E2 M43B19194E1

**SRI030064KSK**

5 pcs



composizione :	q.ty	composition:
CATENA DI DISTRIBUZIONE	1	TIMING CHAIN
TENDICATENA	1	TENSIONER
GUIDA CATENA	2	CHAIN GUIDE
INGRANAGGIO	1	GEAR

adattabile a: suitable for :	motore: engine :
BMW	N40B16A N45B16A

**SRI030062KSK**

5 pcs



composizione :	q.ty	composition:
CATENA DI DISTRIBUZIONE	1	TIMING CHAIN
TENDICATENA	1	TENSIONER
GUIDA CATENA	2	CHAIN GUIDE
INGRANAGGIO	1	GEAR

adattabile a: suitable for :	motore: engine :
BMW	N42B18A N42B20A N46B18A N46B20A N46B20B
	N46B20BD N46B20C N46B20CC N46B20CD N46B20E

**SRI030065KSK**

16 pcs



composizione :	q.ty	composition:
CATENA DI DISTRIBUZIONE	1	TIMING CHAIN
TENDICATENA	1	TENSIONER
PATTINO	3	GUIDE
INGRANAGGIO	3	GEAR
VITI BULLONI	7	SCREWS BOLTS
RONDELLA	1	WASHERS

adattabile a: suitable for :	motore: engine :
ALFA ROMEO	939A5000 939A6000
FIAT	194A1000
OPEL	Z22SE Z22YH
VAUXHALL	Z22SE Z22YH

**KIT TENDICATENA**

**TIMING CHAIN KIT**

**SRI030066KSK**

7 pcs

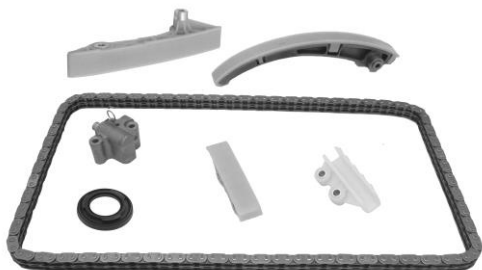

composizione :	q.ty	composition:
CATENA DI DISTRIBUZIONE	1	TIMING CHAIN
TENDICATENA	1	TENSIONER
GUIDA CATENA	4	CHAIN GUIDE
PARAOLIO ALBERO MOTORE	1	CRANK SHAFT OIL SEAL

adattabile a: suitable for :	motore: engine :
FORD	D2FA D2FB D2FE D5BA F4FA FMBA FMBB HJBA HJBB HJBC N7BA

**SRI030067KSK**

6 pcs



composizione :	q.ty	composition:
CATENA DI DISTRIBUZIONE	1	TIMING CHAIN
TENDICATENA	1	TENSIONER
GUIDA CATENA	3	CHAIN GUIDE
PARAOLIO ALBERO MOTORE	1	CRANK SHAFT OIL SEAL

adattabile a: suitable for :	motore: engine :
CITROËN	4HGP22DTE 4HHP22DTE 4HJP22DTE 4HUP22DTE 4HVP22DTE
FIAT	4HV
FORD	CVF5 CVFF CY14 CYF4 CYF5 CYFA CYFB CYFC CYFD CYFF CYFG DRF4 DRF5 DRFA DRFB DRFC DRFD DRFE DRFF DRFG P8FA P8FB PGFA PGFB QVFA QWFA SRFA SRFB SRFC SRFD SRFE UHFA UHFB UHFC
PEUGEOT	4HGP22DTE 4HHP22DTE 4HJP22DTE 4HUP22DTE 4HVP22DTE

**SRI030068KSK**

7 pcs



composizione :	q.ty	composition:
CATENA DI DISTRIBUZIONE	1	TIMING CHAIN
TENDICATENA	1	TENSIONER
GUIDA CATENA	4	CHAIN GUIDE
PARAOLIO ALBERO MOTORE	1	CRANK SHAFT OIL SEAL

adattabile a: suitable for :	motore: engine :
FORD	H9FA H9FB H9FD JXFA JXFC PHFA PHFC

**SRI030069KSK**

7 pcs

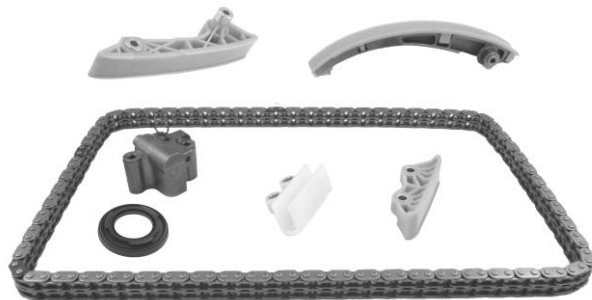

composizione :	q.ty	composition:
CATENA DI DISTRIBUZIONE	1	TIMING CHAIN
TENDICATENA	1	TENSIONER
GUIDA CATENA	4	CHAIN GUIDE
PARAOLIO ALBERO MOTORE	1	CRANK SHAFT OIL SEAL

adattabile a: suitable for :	motore: engine :
FORD	D4FA DOFA HFFA

**KIT TENDICATENA**

**TIMING CHAIN KIT**

**SRI030070KSK**

10 pcs

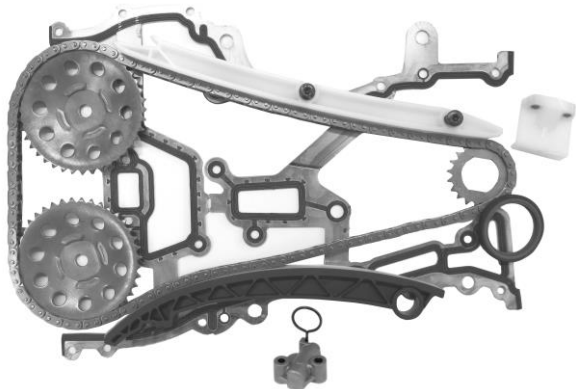

composizione :	q.ty	composition:
CATENA DI DISTRIBUZIONE	1	TIMING CHAIN
TENDICATENA	1	TENSIONER
INGRANAGGIO	3	GEAR
PATTINO	3	GUIDE
GUARNIZIONE POMPA OLIO	1	OIL PUMP GASKET
PARAOLIO ALBERO MOTORE	1	CRANK SHAFT OIL SEAL

adattabile a: suitable for :	motore: engine :	
OPEL	Z12XEP Z14XEL	Z14XEP
VAUXHALL	Z12XEP Z14XEL	Z14XEP

**SRI030072KSK**

15 pcs



composizione :	q.ty	composition:
CATENA DI DISTRIBUZIONE	2	TIMING CHAIN
TENDICATENA	2	TENSIONER
INGRANAGGIO	4	GEAR
PATTINO	7	GUIDE

adattabile a: suitable for :	motore: engine :	
NISSAN	YD25DDTI	

**SRI030071KSK**

13 pcs



composizione :	q.ty	composition:
CATENA DI DISTRIBUZIONE	2	TIMING CHAIN
TENDICATENA	2	TENSIONER
INGRANAGGIO	4	GEAR
PATTINO	5	GUIDE

adattabile a: suitable for :	motore: engine :	
HYUNDAI	D3FA D4FA	D4FB
KIA	D3FA D4FA	D4FB D4FBL

**SRI030073KSK**

6 pcs



composizione :	q.ty	composition:
CATENA DI DISTRIBUZIONE	1	TIMING CHAIN
TENDICATENA	1	TENSIONER
INGRANAGGIO	2	GEAR
PATTINO	2	GUIDE

adattabile a: suitable for :	motore: engine :	
MERCEDES	651911 OM651901 OM651911 OM651912 OM651913 OM651916 OM651921 OM651924 OM651925	OM651930 OM651940 OM651950 OM651955 OM651956 OM651957 OM651960 OM651961 OM651980

**KIT TENDICATENA**

**TIMING CHAIN KIT**

**SRI030074KSK**

6 pcs



composizione :	q.ty	composition:
CATENA DI DISTRIBUZIONE	1	TIMING CHAIN
TENDICATENA	1	TENSIONER
INGRANAGGIO	1	GEAR
PATTINO	3	GUIDE

adattabile a: suitable for :	motore: engine :		
CITROËN	5F01EP6C 5FKEP6CB 5FPEP6 5FSEP6C 5FUEP6CDTX 5FWEP6 5GMPE6FDTX 5GTEP6FDTX	8F01EP3C 8FNEP3 8FNEP3CG 8FPEP3 8FPEP3C 8FREP3 8FSEP3	
	PEUGEOT	5F01EP6C 5FGE6CDTR 5FKEP6CB 5FSEP6C 5FUEP6CDTX 5GTEP6FDTX 8F01EP3C 8FPEP3C 8FREP3 8FREP3C	8FSEP3 EP3 EP3C EP6 EP6C5FH EP6C5FK EP6CDTX EP6FDTR5GN EP6FDTX

**SRI030075KSK**

8 pcs



composizione :	q.ty	composition:
CATENA DI DISTRIBUZIONE	1	TIMING CHAIN
TENDICATENA	1	TENSIONER
INGRANAGGIO	2	GEAR
PATTINO	2	GUIDE
GUARNIZIONE	1	GASKET
PARAOILIO ALBERO MOTORE	1	CRANK SHAFT OIL SEAL

adattabile a: suitable for :	motore: engine :	
ALFA ROMEO	199B4000 199B8000	
CHEVROLET	A13DTCLDV A13DTELSF	
CITROËN	FHYF13DTE6 FHZF13DTE5	
FIAT	199A2000 199A3000 199A9000 199B1000 199B4000 225A2000 263A2000	263A6000 312A8000 312B2000 312B5000 330A1000 55266963 955B2000
	FORD	FD4
	LANCIA	199B1000 312B1000 312B5000
	OPEL	A13DTC A13DTE A13DTR A13FD Z13DT Z13DTE Z13DTH Z13DTJ
	PEUGEOT	199A9000 FHYF13DTE6 FHZF13DTE5
	SUZUKI	D13A Z13DT Z13DTJ
VAUXHALL	A13DTC A13DTE A13DTR A13FD Z13DT Z13DTE Z13DTH Z13DTJ	

**KIT TENDICATENA**

**TIMING CHAIN KIT**

**SRI030077KSK**

19 pcs

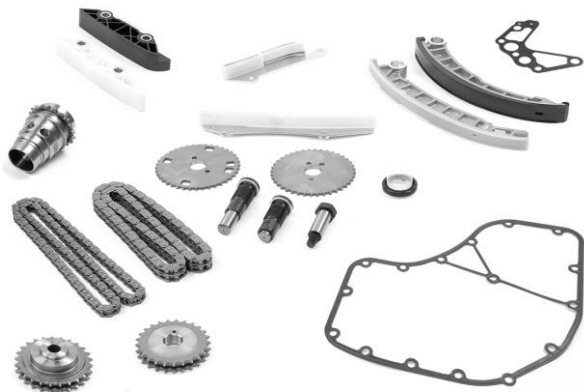

composizione :	q.ty	composition:
CATENA DI DISTRIBUZIONE	2	TIMING CHAIN
TENDICATENA	2	TENSIONER
INGRANAGGIO	5	GEAR
PATTINO	6	GUIDE
VITI BULLONI	1	SCREWS BOLTS
GUARNIZIONE	2	GASKET
PARAOILIO ALBERO MOTORE	1	CRANK SHAFT OIL SEAL

adattabile a: suitable for :	motore: engine :
FIAT	F1CE0481D F1CE3481E F1CE3481M F1CE3481N
IVECO	F1CE3481C F1CE3481CA F1CE3481CB F1CE3481D F1CE3481J F1CE3481K F1CE3481L F1CE3481LC F1CFL411E F1CFL411F F1CFL411G F1CFL411H F1CFL411J

**SRI030080KSK**

4 pcs



composizione :	q.ty	composition:
CATENA DI DISTRIBUZIONE	1	TIMING CHAIN
TENDICATENA	1	TENSIONER
INGRANAGGIO	2	GEAR

adattabile a: suitable for :	motore: engine :
IVECO	F1AE0481A F1AE0481B F1AE0481FA F1AE0481GA F1AE0481HA F1AE0481M F1AE0481UA F1AE0481UB F1AE0481V F1AE0481VA F1AE0481VB F1AE3481A F1AE3481B F1AE3481C F1AFL411A F1AFL411B F1AFL411C F1CE0481A F1CE0481B F1CE0481FA F1CE0481HA F1CE0481HC F1CE0481L F1CE3481CA F1CE3481CB F1CE3481J F1CFL411E F1CFL411J

**SRI030078KSK**

15 pcs



composizione :	q.ty	composition:
CATENA DI DISTRIBUZIONE	1	TIMING CHAIN
TENDICATENA	1	TENSIONER
INGRANAGGIO	2	GEAR
PATTINO	2	GUIDE

adattabile a: suitable for :	motore: engine :
MERCEDES	651911 OM651901 OM651911 OM651912 OM651913 OM651916 OM651924 OM651925 OM651940 OM651955 OM651956 OM651957 OM651960 OM651961

**KIT TENDICATENA**

**TIMING CHAIN KIT**

**SRI030100KSK**

9 pcs



**SRI031000KSK**

25 pcs



composizione :	q.ty	composition:
VITI BULLONI	5	SCREWS BOLTS
FLANGIA KIT RIP. POMPA OLIO	1	OIL PUMP REPAIR KIT FLANGE
COPERCHIO POMPA OLIO	1	OIL PUMP COVER
INGRANAGGIO KIT POMPA OLIO	2	ROTOR GEAR OIL PUMP

adattabile a: suitable for :	motore: engine :	
ALFA ROMEO	199A3000 199B1000 199B4000	199B8000 330A1000
CHEVROLET	A13DTCCLDV	A13DTELSF
CITROËN	FHYF13DTE6	FHZF13DTE5
FIAT	169A1000 169A5000 188A8000 188A9000 199A2000 199A3000 199A9000 199B1000 199B2000 199B4000 199B8000	223A9000 225A2000 263A2000 263A6000 312A8000 312B1000 312B2000 312B5000 330A1000 55266963 955B2000
FORD	FD4	
LANCIA	188A9000 199A2000 199A3000 199A9000	199B1000 312B1000 312B5000
OPEL	A13DTC A13DTE A13DTR A13FD Y13DT	Z13DT Z13DTE Z13DTH Z13DTJ
PEUGEOT	199A9000 FHYF13DTE6	FHZF13DTE5
SUZUKI	D13A Z13DT	Z13DTJ
VAUXHALL	A13DTC A13DTE A13DTR A13FD Y13DT	Z13DT Z13DTE Z13DTH Z13DTJ

composizione :	q.ty	composition:
CATENA DI DISTRIBUZIONE	1	TIMING CHAIN
INGRANAGGIO	2	GEAR
TENDICATENA	1	TENSIONER
PATTINO TENDICATENA DX	1	RIGHT GUIDE
PATTINO TENDICATENA SX	1	LEFT GUIDE
GUARNIZIONE POMPA OLIO	1	OIL PUMP GASKET
PARAOLIO ALBERO MOTORE	1	CRANK SHAFT OIL SEAL
VITI BULLONI	12	SCREWS BOLTS
FLANGIA KIT RIP. POMPA OLIO	1	OIL PUMP REPAIR KIT FLANGE
COPERCHIO POMPA OLIO	1	OIL PUMP COVER
INGRANAGGIO KIT POMPA OLIO	2	ROTOR GEAR OIL PUMP
CONDOTTO DI LUBRIFICAZIONE	1	OIL FEED PIPE

adattabile a: suitable for :	motore: engine :	
ALFA ROMEO	199A3000 199B1000 199B4000	199B8000 330A1000
CHEVROLET	A13DTCCLDV	A13DTELSF
CITROËN	FHYF13DTE6	FHZF13DTE5
FIAT	169A1000 169A5000 188A8000 188A9000 199A2000 199A3000 199A9000 199B1000 199B2000 199B4000 199B8000	223A9000 225A2000 263A2000 263A6000 312A8000 312B1000 312B2000 312B5000 330A1000 55266963 955B2000
FORD	FD4	
LANCIA	188A9000 199A2000 199A3000 199A9000	199B1000 312B1000 312B5000
OPEL	A13DTC A13DTE A13DTR A13FD Y13DT	Z13DT Z13DTE Z13DTH Z13DTJ
PEUGEOT	199A9000 FHYF13DTE6	FHZF13DTE5
SUZUKI	D13A Z13DT	Z13DTJ
VAUXHALL	A13DTC A13DTE A13DTR A13FD Y13DT	Z13DT Z13DTE Z13DTH Z13DTJ



**KIT TENDICATENA**

**TIMING CHAIN KIT**

**SRI031001KSK**

26 pcs



composizione :	q.ty	composition:
CATENA DI DISTRIBUZIONE	1	TIMING CHAIN
INGRANAGGIO	2	GEAR
TENDICATENA	1	TENSIONER
PATTINO	2	GUIDE
PARAOILIO ALBERO MOTORE	1	CRANK SHAFT OIL SEAL
VITI BULLONI	7	OIL PUMP GASKET
GUARNIZIONE CARTER DISTR.	1	TIMING CASE COVER GASKET
FLANGIA KIT RIP. POMPA OLIO	1	OIL PUMP REPAIR KIT FLANGE
CONDOTTO DI LUBRIFICAZIONE	1	OIL FEED PIPE
PESCANTE GUARNIZIONI VITI	8	OIL IN. PIPE GASKET SCREW
CARTER	1	COVER

adattabile a: suitable for :	motore: engine :	
ALFA ROMEO	199A3000 199B1000 199B4000	199B8000 330A1000
CITROËN	FHYF13DTE6	FHZF13DTE5
FIAT	169A1000 169A5000 188A8000 188A9000 199A2000 199A3000 199A9000 199B1000 199B2000 199B4000 199B8000	223A9000 225A2000 263A2000 263A6000 312A8000 312B1000 312B2000 312B5000 330A1000 55266963 955B2000
FORD	FD4	
LANCIA	188A9000 199A2000 199A3000 199A9000	199B1000 312B1000 312B5000
OPEL	A13DTC A13DTE A13DTR A13FD Y13DT	Z13DT Z13DTE Z13DTH Z13DTJ
PEUGEOT	199A9000 FHYF13DTE6	FHZF13DTE5
SUZUKI	D13A Z13DT	Z13DTJ
VAUXHALL	A13DTC A13DTE A13DTR A13FD Y13DT	Z13DT Z13DTE Z13DTH Z13DTJ

**SRI031002KSK**

4 pcs



composizione :	q.ty	composition:
CATENA DI DISTRIBUZIONE SUP	1	UPPER TIMING CHAIN
INGRANAGGIO	2	GEAR
TENDICATENA SUP.	1	UPPER TENSIONER

adattabile a: suitable for :	motore: engine :	
NISSAN	GA14DE GA14DS	GA16DE GA16DS

**SRI031004KSK**

4 pcs



composizione :	q.ty	composition:
CATENA DI DISTRIBUZIONE SUP	1	UPPER TIMING CHAIN
INGRANAGGIO	2	GEAR
TENDICATENA SUP.	1	UPPER TENSIONER

adattabile a: suitable for :	motore: engine :	
NISSAN	CG10DE	CG13DE

**KIT TENDICATENA**

**TIMING CHAIN KIT**

**SRI031005KSK**

4 pcs

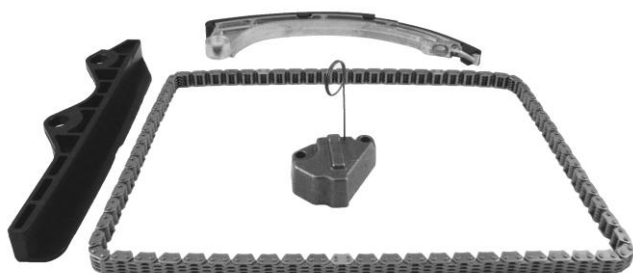

composizione :	q.ty	composition:
CATENA DI DISTRIBUZIONE	1	TIMING CHAIN
PATTINO TENDICATENA DX	1	RIGHT GUIDE
PATTINO TENDICATENA SX	1	LEFT GUIDE
TENDICATENA	1	TENSIONER

adattabile a: suitable for :	motore: engine :
NISSAN	CG10DE

**SRI03100PKSK**

16 pcs

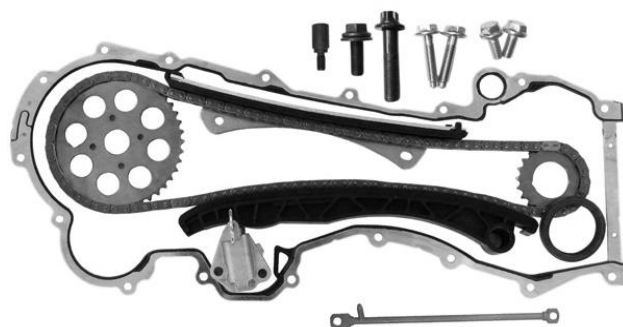

composizione :	q.ty	composition:
CATENA DI DISTRIBUZIONE	1	TIMING CHAIN
INGRANAGGIO	2	GEAR
TENDICATENA	1	TENSIONER
PATTINO TENDICATENA DX	1	RIGHT GUIDE
PATTINO TENDICATENA SX	1	LEFT GUIDE
GUARNIZIONE POMPA OLIO	1	OIL PUMP GASKET
PARAOLIO ALBERO MOTORE	1	CRANK SHAFT OIL SEAL
VITI BULLONI	7	SCREWS BOLTS
CONDOTTO DI LUBRIFICAZIONE	1	OIL FEED PIPE

adattabile a: suitable for :	motore: engine :	
ALFA ROMEO	199A3000 199B1000 199B4000	199B8000 330A1000
CHEVROLET	A13DTC	A13DTELSF
CITROËN	FHYF13DTE6	FHZF13DTE5
FIAT	169A1000 169A5000 188A8000 188A9000 199A2000 199A3000 199A9000 199B1000 199B2000 199B4000 199B8000	223A9000 225A2000 263A2000 263A6000 312A8000 312B1000 312B2000 312B5000 330A1000 55266963 955B2000
FORD	FD4	
LANCIA	188A9000 199A2000 199A3000 199A9000	199B1000 312B1000 312B5000
OPEL	A13DTC A13DTE A13DTR A13FD Y13DT	Z13DT Z13DTE Z13DTH Z13DTJ
PEUGEOT	199A9000 FHYF13DTE6	FHZF13DTE5
SUZUKI	D13A Z13DT	Z13DTJ
VAUXHALL	A13DTC A13DTE A13DTR A13FD Y13DT	Z13DT Z13DTE Z13DTH Z13DTJ

**SRI031007KSK**

4 pcs



composizione :	q.ty	composition:
CATENA DI DISTRIBUZIONE	1	TIMING CHAIN
PATTINO TENDICATENA	2	GUIDE
TENDICATENA	1	TENSIONER

adattabile a: suitable for :	motore: engine :
TOYOTA	1ZZFE 3ZZFE 4ZZFE

**KIT TENDICATENA**

**TIMING CHAIN KIT**

**SRI031012KSK**

4 pcs



composizione :	q.ty	composition:
CATENA DI DISTRIBUZIONE	1	TIMING CHAIN
PATTINO TENDICATENA DX	1	RIGHT GUIDE
PATTINO TENDICATENA SX	1	LEFT GUIDE
TENDICATENA	1	TENSIONER

adattabile a: suitable for :	motore: engine :
TOYOTA	1SZFE

**SRI031018KSK**

9 pcs

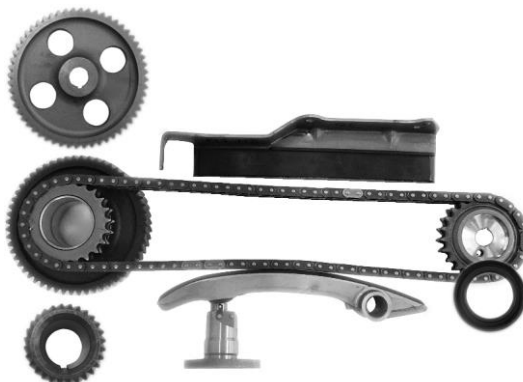

composizione :	q.ty	composition:
CATENA DI DISTRIBUZIONE	1	TIMING CHAIN
TENDICATENA	1	TENSIONER
INGRANAGGIO	4	GEAR
GUIDA CATENA	2	CHAIN GUIDE
PARAOILIO ALBERO MOTORE	1	CRANK SHAFT OIL SEAL

adattabile a: suitable for :	motore: engine :
MITSUBISHI	4M40A 4M40T

**SRI031017KSK**

4 pcs



composizione :	q.ty	composition:
CATENA DI DISTRIBUZIONE	1	TIMING CHAIN
PATTINO TENDICATENA DX	1	RIGHT GUIDE
PATTINO TENDICATENA SX	1	LEFT GUIDE
TENDICATENA	1	TENSIONER

adattabile a: suitable for :	motore: engine :
CITROËN	1KRFE
DAIHATSU	1KRFE
PEUGEOT	1KR384F 384F 1KRFE CFA384F
TOYOTA	1KRFE

**SRI031019KSK**

6 pcs



composizione :	q.ty	composition:
CATENA DI DISTRIBUZIONE	1	TIMING CHAIN
PATTINO TENDICATENA DX	1	RIGHT GUIDE
PATTINO TENDICATENA SX	1	LEFT GUIDE
TENDICATENA	1	TENSIONER
INGRANAGGIO	2	GEAR

adattabile a: suitable for :	motore: engine :
MITSUBISHI	4M41

**KIT TENDICATENA**

**TIMING CHAIN KIT**

**SRI031022KSK**

6 pcs



composizione :	q.ty	composition:
CATENA DI DISTRIBUZIONE	1	TIMING CHAIN
PATTINO TENDICATENA DX	1	RIGHT GUIDE
PATTINO TENDICATENA SX	1	LEFT GUIDE
TENDICATENA	1	TENSIONER
INGRANAGGIO	2	GEAR

adattabile a: suitable for :	motore: engine :
SMART	M160910 M160920 M160921 M160922 M160923 M160E6ALB03 M160E6ALB04 M160E6ALB05

**SRI031024KSK**

5 pcs



composizione :	q.ty	composition:
CATENA DI DISTRIBUZIONE	1	TIMING CHAIN
PATTINO TENDICATENA DX	1	RIGHT GUIDE
PATTINO TENDICATENA SX	1	LEFT GUIDE
TENDICATENA	1	TENSIONER
PATTINO	1	GUIDE

adattabile a: suitable for :	motore: engine :
OPEL	X10XE X12XE Z10XE Z10XEP Z12XE Z12XEP Z14XEL Z14XEP
SUZUKI	Z10XEP Z12XEP
VAUXHALL	X10XE X12XE Z10XE Z10XEP Z12XE Z12XEP Z14XEL Z14XEP

**SRI031023KSK**

19 pcs

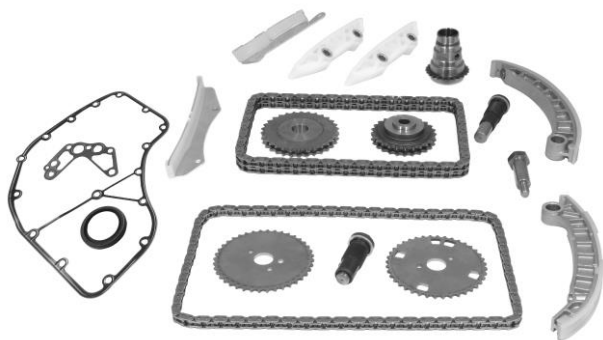

composizione :	q.ty	composition:
CATENA DI DISTRIBUZIONE INF.	1	LOWER TIMING CHAIN
CATENA DI DISTRIBUZIONE SUP.	1	UPPERTIMING CHAIN
INGRANAGGIO	5	GEAR
PATTINO	6	GUIDE
GUARNIZIONE	2	GASKET
TENDICATENA	2	TENSIONER
PARAOILIO ALBERO MOTORE	1	CRANK SHAFT OIL SEAL
VITI BULLONI	1	SCREWS BOLTS

adattabile a: suitable for :	motore: engine :
CITROËN	F1CE0481DF30DT F1CE3481IEF30DTE
FIAT	F1CE3481N
IVECO	F1CE0441A F1CE0481A F1CE0481B F1CE0481FA F1CE0481HA F1CE0481HC F1CE0481L F1CE0481P F1CFA401A
PEUGEOT	F1CE0481DF30DT F30DT

**SRI031025KSK**

6 pcs



composizione :	q.ty	composition:
CATENA DI DISTRIBUZIONE	1	TIMING CHAIN
PATTINO TENDICATENA DX	1	RIGHT GUIDE
PATTINO TENDICATENA SX	1	LEFT GUIDE
TENDICATENA	1	TENSIONER

adattabile a: suitable for :	motore: engine :
FIAT	M16A
SUZUKI	M13A M15A M16A M18A

**KIT TENDICATENA**

**TIMING CHAIN KIT**

**SRI031026KSK**

5 pcs



composizione :	q.ty	composition:
CATENA DI DISTRIBUZIONE	1	TIMING CHAIN
PATTINO TENDICATENA	2	GUIDE
GUIDA	1	GUIDE
TENDICATENA	1	TENSIONER

adattabile a: suitable for :	motore: engine :
TOYOTA	2SZFE

**SRI031030KSK**

5 pcs



composizione :	q.ty	composition:
CATENA DI DISTRIBUZIONE	1	TIMING CHAIN
PATTINO TENDICATENA DX	1	RIGHT GUIDE
PATTINO TENDICATENA SX	1	LEFT GUIDE
TENDICATENA	1	TENSIONER
PARAOILIO ALBERO MOTORE	1	CRANK SHAFT OIL SEAL

adattabile a: suitable for :	motore: engine :
SMART	M132910 M132930

**SRI031029KSK**

7 pcs



composizione :	q.ty	composition:
CATENA DI DISTRIBUZIONE	1	TIMING CHAIN
INGRANAGGIO	2	GEAR
PATTINO TENDICATENA DX	1	RIGHT GUIDE
PATTINO TENDICATENA SX	1	LEFT GUIDE
TENDICATENA	1	TENSIONER
PARAOILIO ALBERO MOTORE	1	CRANK SHAFT OIL SEAL

adattabile a: suitable for :	motore: engine :
SMART	OM660940 OM660950 OM660951 OM660DE8LA

**SRI031037KSK**

15 pcs



composizione :	q.ty	composition:
CATENA DI DISTRIBUZIONE	1	TIMING CHAIN
CATENA POMPA OLIO	1	OIL PUMP CHAIN
INGRANAGGIO	5	GEAR
PATTINO TENDICATENA DX	1	RIGHT GUIDE
PATTINO TENDICATENA SX	1	LEFT GUIDE
GUIDA TENDICATENA	1	TENSIONER GUIDE
TENDICATENA	1	TENSIONER
PARAOILIO ALBERO MOTORE	1	CRANK SHAFT OIL SEAL
VITI BULLONI	3	SCREWS BOLTS

adattabile a: suitable for :	motore: engine :
SEAT	AZQ BME BXV BZG
SKODA	AZQ BME BXV BZG
VOLKSWAGEN	AZQ BME BZG

**KIT TENDICATENA**

**TIMING CHAIN KIT**

**SRI031038KSK**

10 pcs

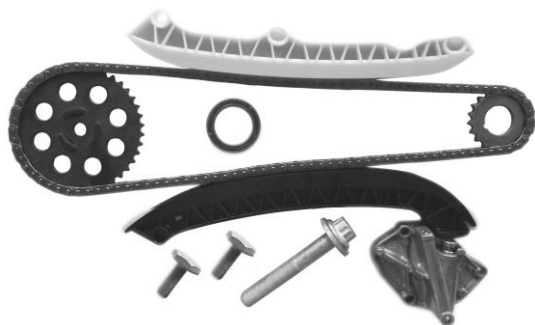

composizione :	q.ty	composition:
CATENA DI DISTRIBUZIONE	1	TIMING CHAIN
INGRANAGGIO	2	GEAR
PATTINO TENDICATENA DX	1	RIGHT GUIDE
PATTINO TENDICATENA SX	1	LEFT GUIDE
TENDICATENA	1	TENSIONER
PARAOLIO ALBERO MOTORE	1	CRANK SHAFT OIL SEAL
VITI BULLONI	3	SCREWS BOLTS

adattabile a: suitable for :	motore: engine :	
SEAT	BBM	
SKODA	AWY BBM	BMD
VOLKSWAGEN	AWY BBM BMD	CHFA CHFB

**SRI031041KSK**

4 pcs



composizione :	q.ty	composition:
CATENA DI DISTRIBUZIONE	1	TIMING CHAIN
PATTINO TENDICATENA DX	1	RIGHT GUIDE
PATTINO TENDICATENA SX	1	LEFT GUIDE
TENDICATENA	1	TENSIONER

adattabile a: suitable for :	motore: engine :			
NISSAN	M9R M9R630A6 M9R692F6 M9R760	M9R780 M9R782 M9R786M7		
	OPEL	M9R630 M9R692 M9R780 M9R782	M9R784 M9R786 M9R788	
		RENAULT	M9R610 M9R615 M9R630 M9R692 M9R700 M9R721 M9R722 M9R724 M9R740 M9R742 M9R744 M9R750 M9R756 M9R760 M9R761 M9R762 M9R763 M9R780 M9R782 M9R784 M9R786 M9R800 M9R802 M9R804 M9R805 M9R806 M9R808 M9R809 M9R811 M9R812K8 M9R814	M9R815 M9R816 M9R817 M9R820 M9R824 M9R830 M9R832 M9R834V8 M9R83528 M9R836H8 M9R839 M9R844 M9R845 M9R846 M9R849 M9R855 M9R856 M9R857 M9R858 M9R859 M9R862 M9R864 M9R865 M9R866 M9RA700 M9RA742 M9RD833 M9RG832 M9RK800 M9RK802
			VAUXHALL	M9R630 M9R692 M9R780 M9R782

**KIT TENDICATENA**

**TIMING CHAIN KIT**

**SRI031042KSK**

4 pcs



composizione :	q.ty	composition:
CATENA DI DISTRIBUZIONE	1	TIMING CHAIN
PATTINO TENDICATENA DX	1	RIGHT GUIDE
PATTINO TENDICATENA SX	1	LEFT GUIDE
TENDICATENA	1	TENSIONER

adattabile a: suitable for :	motore: engine :
BMW	M47D20204D4 M57D30306D4 M47N204D4 M57D30306D5 M57306D3 M57N2306D2 M57D25256D2 M57N2306D3 M57D30306D2 M57N306D2 M57D30306D3 M57N306D5

**SRI031044KSK**

13 pcs



composizione :	q.ty	composition:
CATENA DI DISTRIBUZ. INF.DX	1	LOWER RIGHT TIMING CHAIN
CATENA DI DISTRIBUZ. INF.SX	1	LOWER LEFT TIMING CHAIN
CATENA DI DISTRIBUZIONE SUP.	1	UPPER TIMING CHAIN
PATTINO TENDICATENA INF.DX	6	LOWER RIGHT GUIDE
GUIDA TENDICATENA	1	TENSIONER GUIDE
TENDICATENA SUPERIORE	1	UPPER TENSIONER
TENDICATENA INF.DX	1	LOWER RIGHT TENSIONER
TENDICATENA INF.SX	1	LOWER LEFT TENSIONER

adattabile a: suitable for :	motore: engine :
HYUNDAI	D4CB
KIA	D4CB

**SRI031043KSK**

6 pcs



composizione :	q.ty	composition:
CATENA DI DISTRIBUZIONE	1	TIMING CHAIN
PATTINO TENDICATENA DX	1	RIGHT GUIDE
PATTINO TENDICATENA SX	1	LEFT GUIDE
TENDICATENA	1	TENSIONER
INGRANAGGIO	2	GEAR

adattabile a: suitable for :	motore: engine :
BMW	N47D16A N47D20C N47D20A N47D20D N47D20B
MINI	N47C16A N47C20A

**SRI031045KSK**

5 pcs



composizione :	q.ty	composition:
CATENA DI DISTRIBUZIONE	1	TIMING CHAIN
GUIDA CATENA	3	GUIDE
TENDICATENA	1	TENSIONER

adattabile a: suitable for :	motore: engine :
FIAT	194A1000
OPEL	Z20NET Z22SE Z22YH
VAUXHALL	Z20NET Z22SE Z22YH

**KIT TENDICATENA**

**TIMING CHAIN KIT**

**SRI031046KSK**

5 pcs



composizione :	q.ty	composition:
CATENA DI DISTRIBUZIONE	1	TIMING CHAIN
GUIDA CATENA	3	GUIDE
TENDICATENA	1	TENSIONER

adattabile a: suitable for :	motore: engine :	
CITROËN	5F04EP6CDT	5FREP6DT
	5FDEP6DTS	5FSEP6DTS
	5FEFP6CDTMD	5FTEP6DT
	5FMFP6CDTMD	5FVEP6CDT
	5FMFP6DT	5FXEP6DT
PEUGEOT	5F02EP6CDT	5FYEP6DTS
	5F04EP6CDT	5G02EP6FDTM
	5FAEP6CDT	5G02EP6FDTMD
	5FEFP6CDTMD	5GXEP6FDTMD
	5FMFP6CDTMD	5GYEP6FDTM
	5FNFP6CDT	5GZEP6FDT
	5FREP6DT	EP6CDT
	5FTEP6DT	EP6CDTM5FM
	5FVEP6CDT	EP6FDTMD
	5FVEP6DT	

**SRI031049KSK**

8 pcs



composizione :	q.ty	composition:
CATENA DI DISTRIBUZIONE	2	TIMING CHAIN
INGRANAGGIO	2	GEAR
SLITTA DOPPIA	1	DOUBLE GUIDE
TENDITORE	1	TENSIONER
GUARNIZIONE	1	GASKET
PARAOILIO ALBERO MOTORE	1	CRANK SHAFT OIL SEAL

adattabile a: suitable for :	motore: engine :	
FORD	BHDA	P7PB
	BHDB	P9PA
	BHPA	P9PB
	C9DA	P9PC
	C9DB	P9PD
	C9DC	QYBA
	C9DE	QYWVA
	F9DA	R2PA
	F9DB	R3PA
	FFBA	RTN
	FFDA	RTP
	FFWA	RTQ
	HCPA	RWPA
	HCPB	RWPC
	KHBA	RWPD
	KKDA	RWPE
	KKDB	RWPF
	P7PA	

**SRI031048KSK**

4 pcs



composizione :	q.ty	composition:
CATENA DI DISTRIBUZIONE	1	TIMING CHAIN
GUIDA CATENA	2	GUIDE
TENDICATENA	1	TENSIONER

adattabile a: suitable for :	motore: engine :	
OPEL	X20DTH	Y20DTL
	X20DTL	Y22DTH
	X22DTH	Y22DTR
	Y20DTH	
VAUXHALL	X20DTH	Y20DTL
	X20DTL	Y22DTH
	X22DTH	Y22DTR
	Y20DTH	

**SRI031052KSK**

4 pcs



composizione :	q.ty	composition:
CATENA DI DISTRIBUZIONE	1	TIMING CHAIN
PATTINO TENDICATENA DX	1	RIGHT GUIDE
PATTINO TENDICATENA SX	1	LEFT GUIDE
TENDICATENA	1	TENSIONER

adattabile a: suitable for :	motore: engine :	
FORD	A9A	BAJA
	A9B	CDB
	A9JA	CDC
	A9JB	CDRB



**KIT TENDICATENA**

**TIMING CHAIN KIT**

**SRI031054KSK**

4 pcs

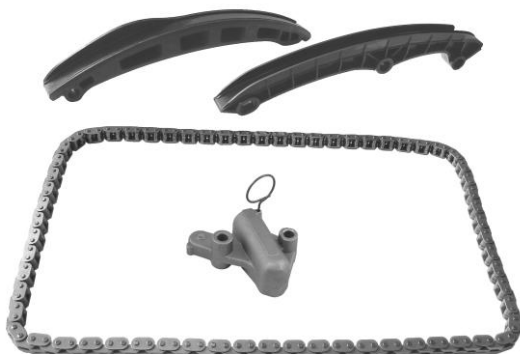

composizione :	q.ty	composition:
CATENA DI DISTRIBUZIONE	1	TIMING CHAIN
GUIDA CATENA	2	GUIDE
TENDICATENA	1	TENSIONER

adattabile a: suitable for :	motore: engine :
AUDI	BAG CAXC BLF CMSA BLP CNVA CAVG CTHG CAXA CTJA
SEAT	BTS CNUB CAVA CNWB CAVE CTHA CAVF CTHE CAXA CTHF CAXC CTJB CFNA CTJC CNKA
SKODA	BLF CAXC BTS CFNA CAXA
VOLKSWAGEN	AXU CDGA BAG CFNA BKG CFNB BLF CKMA BLG CLPA BLN CLRA BLP CLSA BMY CMSB BTS CNKA BWK CNWA CAVA CTHA CAVC CTHB CAVD CTHC CAVE CTHD CAXA CTHE CDDA CTKA

**SRI031055KSK**

4 pcs



composizione :	q.ty	composition:
CATENA DI DISTRIBUZIONE	1	TIMING CHAIN
GUIDA CATENA	2	GUIDE
TENDICATENA	1	TENSIONER

adattabile a: suitable for :	motore: engine :
ALFA ROMEO	199B6000 312A2000
FIAT	199B6000 312A5000 312A2000 312A6000 312A4000 312A7000
LANCIA	312A2000 312A5000

**SRI031056KSK**

5 pcs

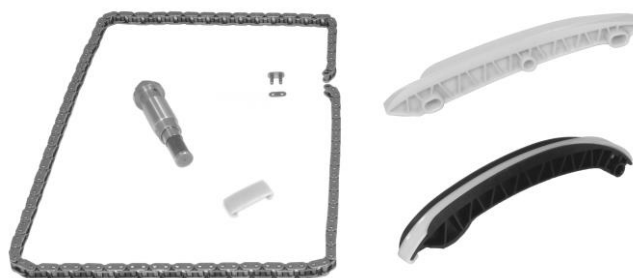

composizione :	q.ty	composition:
CATENA DI DISTRIBUZIONE	1	TIMING CHAIN
PATTINO TENDICATENA	3	GUIDE
TENDICATENA	1	TENSIONER

adattabile a: suitable for :	motore: engine :
MERCEDES	M271910 M271950 M271911 M271951 M271921 M271952 M271940 M271954 M271941 M271955 M271942 M271956 M271944 M271957 M271946 M271958 M271948

**KIT TENDICATENA**

**TIMING CHAIN KIT**

**SRI031057KSK**

4 pcs



composizione :	q.ty	composition:
CATENA DI DISTRIBUZIONE	1	TIMING CHAIN
PATTINO	2	GUIDE
TENDICATENA	1	TENSIONER

adattabile a: suitable for :	motore: engine :
AUDI	CBZA CBZB
SEAT	CBZB
SKODA	CBZA CBZB
VOLKSWAGEN	CBZA CBZB CBZC

**SRI031062KSK**

4 pcs



composizione :	q.ty	composition:
CATENA DI DISTRIBUZIONE	1	TIMING CHAIN
GUIDA CATENA	2	GUIDE
TENDICATENA	1	TENSIONER

adattabile a: suitable for :	motore: engine :
BMW	N42B18A N42B20A N46B18A N46B20A N46B20B N46B20BD N46B20C N46B20CC N46B20CD N46B20E N46NB20B

**SRI031058KSK**

6 pcs

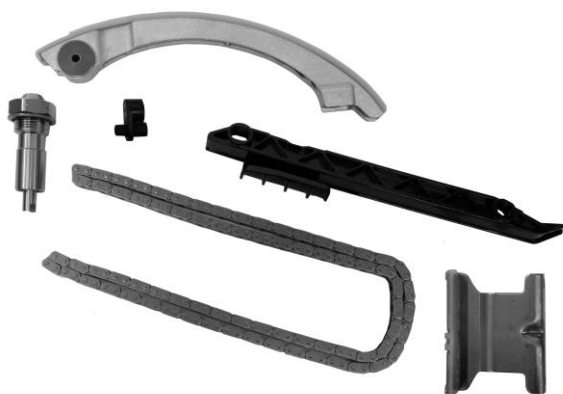

composizione :	q.ty	composition:
CATENA DI DISTRIBUZIONE	1	TIMING CHAIN
GUIDA CATENA	3	GUIDE
TENDICATENA	1	TENSIONER
GRUPPO GETTO	1	OIL NOZZLE

adattabile a: suitable for :	motore: engine :
FIAT	194A1000
OPEL	Z20NET Z22SE Z22YH
VAUXHALL	Z20NET Z22SE Z22YH

**SRI031063KSK**

2 pcs



composizione :	q.ty	composition:
CATENA DI DISTRIBUZIONE	1	TIMING CHAIN
GUIDA TENDICATENA	1	TENSIONER GUIDE

adattabile a: suitable for :	motore: engine :
AUDI	AMF ANY ATL BHC
SEAT	AMF BMS BNM BNV
SKODA	AMF BMS BNM BNV
VOLKSWAGEN	AMF ANY BMS AYZ BNM BAY BNV BWB

**KIT TENDICATENA**

**TIMING CHAIN KIT**

**SRI031064KSK**

4 pcs



composizione :	q.ty	composition:
CATENA DI DISTRIBUZIONE	1	TIMING CHAIN
GUIDA CATENA	2	GUIDE
TENDICATENA	1	TENSIONER

adattabile a: suitable for :	motore: engine :
BMW	N40B16A N45B16A

**SRI031066KSK**

9 pcs



composizione :	q.ty	composition:
CATENA POMPA OLIO	1	OIL PUMP CHAIN
INGRANAGGIO	2	GEAR
TENDICATENA	1	TENSIONER
PATTINO	4	GUIDE
PARAOLIO ALBERO MOTORE	1	CRANK SHAFT OIL SEAL

adattabile a: suitable for :	motore: engine :
FORD	D2FA D2FB D2FE D5BA F4FA FMBA FMBB HJBA HJBB HJBC N7BA

**SRI031065KSK**

13 pcs



composizione :	q.ty	composition:
CATENA DI DISTRIBUZIONE	1	TIMING CHAIN
PATTINO	3	GUIDE
TENDICATENA	1	TENSIONER
VITI BULLONI	7	SCREWS BOLTS
RONDELLA	1	WASHERS

adattabile a: suitable for :	motore: engine :
ALFA ROMEO	939A5000 939A6000
FIAT	194A1000
OPEL	Z22SE Z22YH
VAUXHALL	Z22SE Z22YH

**KIT TENDICATENA**

**TIMING CHAIN KIT**

**SRI031067KSK**

9 pcs



composizione :	q.ty	composition:
CATENA POMPA OLIO	1	OIL PUMP CHAIN
INGRANAGGIO	3	GEAR
TENDICATENA	1	TENSIONER
PATTINO	3	GUIDE
PARAOILIO ALBERO MOTORE	1	CRANK SHAFT OIL SEAL

adattabile a: suitable for :	motore: engine :	
CITROËN	4HGP22DTE 4HHP22DTE 4HJP22DTE	4HUP22DTE 4HVP22DTE
FIAT	4HV	
FORD	CVF5 CVFF CY14 CYF4 CYF5 CYFA CYFB CYFC CYFD CYFF CYFG DRF4 DRF5 DRFA DRFB DRFC DRFD	DRFE DRFF DRFG P8FA P8FB PGFA PGFB QVFA QWFA SRFA SRFB SRFC SRFD SRFE UHFA UHFB UHFC
PEUGEOT	4HGP22DTE 4HHP22DTE 4HJP22DTE	4HUP22DTE 4HVP22DTE

**SRI031068KSK**

11 pcs



composizione :	q.ty	composition:
CATENA POMPA OLIO	1	OIL PUMP CHAIN
INGRANAGGIO	4	GEAR
TENDICATENA	1	TENSIONER
PATTINO	4	GUIDE
PARAOILIO ALBERO MOTORE	1	CRANK SHAFT OIL SEAL

adattabile a: suitable for :	motore: engine :	
FORD	H9FA H9FB H9FD JXFA	JXFC PHFA PHFC

**SRI031069KSK**

11 pcs



composizione :	q.ty	composition:
CATENA POMPA OLIO	1	OIL PUMP CHAIN
INGRANAGGIO	4	GEAR
TENDICATENA	1	TENSIONER
PATTINO	4	GUIDE
PARAOILIO ALBERO MOTORE	1	CRANK SHAFT OIL SEAL

adattabile a: suitable for :	motore: engine :	
FORD	D4FA DOFA HFFA	

**KIT TENDICATENA**

**TIMING CHAIN KIT**

**SRI031070KSK**

5 pcs



composizione :	q.ty	composition:
CATENA DI DISTRIBUZIONE	1	TIMING CHAIN
PATTINO	3	GUIDE
TENDICATENA	1	TENSIONER

adattabile a: suitable for :	motore: engine :
CHEVROLET	A12XEL A12XER A14NELLUJ A14NET A14NETLUV A14XER B14NET LDD LUU
OPEL	A10XEP A12XEL A12XER A14NEL A14NET A14XEL A14XER A14XFL B12XEL B14NEH B14NEHLUJ B14NEJ B14NEL B14NELLUH B14NET B14NETLUJ B14XEJ B14XEL B14XER B14XERLDD Z12XEP Z14XEL Z14XEP
VAUXHALL	A10XEP A12XEL A12XER A14NEL A14NET A14XEL A14XER A14XFL B12XEL B14NEH B14NEHLUJ B14NEJ B14NEL B14NELLUH B14NET B14NETLUJ B14XEJ B14XEL B14XER B14XERLDD Z12XEP Z14XEL Z14XEP

**SRI031071KSK**

9 pcs



composizione :	q.ty	composition:
CATENA DI DISTRIBUZIONE	2	TIMING CHAIN
PATTINO	5	GUIDE
TENDICATENA	2	TENSIONER

adattabile a: suitable for :	motore: engine :
HYUNDAI	D3FA D4FA D4FB
KIA	D3FA D4FA D4FB D4FBL

**SRI031072KSK**

11 pcs



composizione :	q.ty	composition:
CATENA DI DISTRIBUZIONE	2	TIMING CHAIN
PATTINO	7	GUIDE
TENDICATENA	2	TENSIONER

adattabile a: suitable for :	motore: engine :
NISSAN	YD25DDTI

**KIT TENDICATENA**

**TIMING CHAIN KIT**

**SRI031073KSK**

4 pcs



composizione :	q.ty	composition:
CATENA DI DISTRIBUZIONE	1	TIMING CHAIN
PATTINO	2	GUIDE
TENDICATENA	1	TENSIONER

adattabile a: suitable for :	motore: engine :
MERCEDES	651911 OM651930
	OM651901 OM651940
	OM651911 OM651950
	OM651912 OM651955
	OM651913 OM651956
	OM651916 OM651957
	OM651921 OM651960
	OM651924 OM651961
	OM651925 OM651980

**SRI031074KSK**

5 pcs



composizione :	q.ty	composition:
CATENA DI DISTRIBUZIONE	1	TIMING CHAIN
PATTINO	3	GUIDE
TENDICATENA	1	TENSIONER

adattabile a: suitable for :	motore: engine :	
CITROËN	5F01EP6C 8F01EP3C	
	5FKEP6CB 8FNFP3	
	5FPEP6 8FNFP3CG	
	5FSEP6C 8FPEP3	
	5FUPE6CDTX 8FPEP3C	
	5FWEP6 8FREP3	
	5GMEP6FDTX 8FSEP3	
	5GTEP6FDTX	
	PEUGEOT	5F01EP6C 8FSEP3
		5FGPE6CDTR EP3
5FKEP6CB EP3C		
5FSEP6C EP6		
5FUPE6CDTX EP6C5FH		
5GTEP6FDTX EP6C5FK		
8F01EP3C EP6CDTX		
8FPEP3C EP6FDTR5GN		
8FREP3 EP6FDTX		
8FREP3C		

**SRI031076KSK**

7 pcs



composizione :	q.ty	composition:
CATENA DI DISTRIBUZIONE	2	TIMING CHAIN
PATTINO	4	GUIDE
TENDICATENA	1	TENSIONER

adattabile a: suitable for :	motore: engine :
BMW	M41D17174T1 M41D18 M51D25256T1

**SRI031077KSK**

8 pcs



composizione :	q.ty	composition:
CATENA DI DISTRIBUZIONE	1	TIMING CHAIN
PATTINO	3	GUIDE
TENDICATENA	2	TENSIONER
INGRANAGGIO	2	GEAR

adattabile a: suitable for :	motore: engine :	
FIAT	F1CE0481D F1CE3481E	F1CE3481M F1CE3481N
	IVECO	F1CE3481C F1CE3481CA F1CE3481CB F1CE3481D F1CE3481J F1CE3481K F1CE3481L

**KIT TENDICATENA**

**TIMING CHAIN KIT**

**SRI031078KSK**

4 pcs



composizione :	q.ty	composition:
CATENA DI DISTRIBUZIONE	1	TIMING CHAIN
PATTINO	2	GUIDE
TENDICATENA	1	TENSIONER

adattabile a: suitable for :	motore: engine :
MERCEDES	651911 OM651901 OM651911 OM651912 OM651913 OM651916 OM651924 OM651925 OM651940 OM651955 OM651956 OM651957 OM651960 OM651961

**SRI031083KSK**

3 pcs

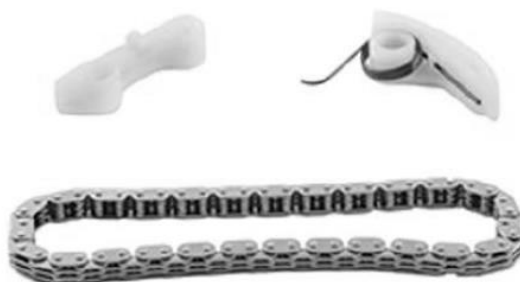

composizione :	q.ty	composition:
CATENA POMPA OLIO	1	OIL PUMP CHAIN
PATTINO	1	GUIDE
TENDICATENA	1	TENSIONER

adattabile a: suitable for :	motore: engine :
FORD	AOBA AOWB COWB COWC COWD COWE COWF COWG COWH COWI COWJ COWK COWL COWM COWN COWO COWP COWQ COWR COWS COWT COWU COWV COWW COWX COWY COWZ GZFB GZFC GZFD GZFE GZFF GZFG GZFH GZFI GZFJ GZFK GZFL GZFM GZFN GZFO GZFP GZFQ GZFR GZFS GZFT GZFU GZFV GZFV GZFW GZFX GZFY GZFZ

**SRI031079KSK**

4 pcs



composizione :	q.ty	composition:
CATENA DI DISTRIBUZIONE	1	TIMING CHAIN
PATTINO	2	GUIDE
TENDICATENA	1	TENSIONER

adattabile a: suitable for :	motore: engine :
MERCEDES	OM640940 OM640941 OM640942
SMART	OM639939

**KIT TENDICATENA**

**TIMING CHAIN KIT**

**SRI032000KSK**

6 pcs



composizione :	q.ty	composition:
CATENA DI DISTRIBUZIONE	1	TIMING CHAIN
TENDICATENA	1	TENSIONER
INGRANAGGIO	2	GEAR
PATTINO TENDICATENA DX	1	RIGHT GUIDE
PATTINO TENDICATENA SX	1	LEFT GUIDE

adattabile a: suitable for :	motore: engine :	
ALFA ROMEO	199A3000 199B1000 199B4000	199B8000 330A1000
CHEVROLET	A13DTCLDV	A13DTELSF
CITROËN	FHYF13DTE6	FHZF13DTE5
FIAT	169A1000 169A5000 188A8000 188A9000 199A2000 199A3000 199A9000 199B1000 199B2000 199B4000 199B8000	223A9000 225A2000 263A2000 263A6000 312A8000 312B1000 312B2000 330A1000 55266963 955B2000
FORD	FD4	
LANCIA	188A9000 199A2000 199A3000 199A9000	199B1000 312B1000 312B5000
OPEL	A13DTC A13DTE A13DTR A13FD	Z13DT Z13DTE Z13DTH Z13DTJ
PEUGEOT	199A9000 FHYF13DTE6	FHZF13DTE5
SUZUKI	D13A Z13DT	Z13DTJ
VAUXHALL	A13DTC A13DTE A13DTR A13FD	Z13DT Z13DTE Z13DTH Z13DTJ

**SRI032002KSK**

7 pcs



composizione :	q.ty	composition:
CATENA DI DISTRIBUZIONE	1	TIMING CHAIN
INGRANAGGIO	2	GEAR
PATTINO TENDICATENA DX	1	RIGHT GUIDE
PATTINO TENDICATENA SX	1	LEFT GUIDE
GUARNIZIONE	1	GASKET
TENDICATENA INFERIORE	1	LOWER TENSIONER

adattabile a: suitable for :	motore: engine :	
NISSAN	GA14DE GA14DS	GA16DE GA16DS

**SRI032004KSK**

6 pcs



composizione :	q.ty	composition:
CATENA DI DISTRIBUZIONE	1	TIMING CHAIN
INGRANAGGIO	2	GEAR
PATTINO TENDICATENA DX	1	RIGHT GUIDE
PATTINO TENDICATENA SX	1	LEFT GUIDE
TENDICATENA INFERIORE	1	LOWER TENSIONER

adattabile a: suitable for :	motore: engine :	
NISSAN	CG10DE	CG13DE



**KIT TENDICATENA**

**TIMING CHAIN KIT**

**SRI032007KSK**

7 pcs



composizione :	q.ty	composition:
CATENA DI DISTRIBUZIONE	1	TIMING CHAIN
INGRANAGGIO	2	GEAR
PATTINO	2	GUIDE
TENDICATENA	1	TENSIONER
PARAOILIO ALBERO MOTORE	1	CRANK SHAFT OIL SEAL

adattabile a: suitable for :	motore: engine :
TOYOTA	1ZZFE 3ZZFE      4ZZFE

**SRI032019KSK**

4 pcs



composizione :	q.ty	composition:
CATENA DI DISTRIBUZIONE	1	TIMING CHAIN
PATTINO TENDICATENA DX	1	RIGHT GUIDE
PATTINO TENDICATENA SX	1	LEFT GUIDE
TENDICATENA	1	TENSIONER

adattabile a: suitable for :	motore: engine :
MITSUBISHI	4M41

**SRI032018KSK**

4 pcs



composizione :	q.ty	composition:
CATENA DI DISTRIBUZIONE	1	TIMING CHAIN
GUIDA CATENA	2	GUIDE
TENDICATENA	1	TENSIONER

adattabile a: suitable for :	motore: engine :
MITSUBISHI	4M40A      4M40T

**SRI032022KSK**

6 pcs



composizione :	q.ty	composition:
CATENA POMPA OLIO	1	OIL PUMP CHAIN
INGRANAGGIO	2	GEAR
TUBETTO LUBRIFICAZ. OLIO	1	OIL FEED PIPE
PATTINO	1	GUIDE
PARAOILIO ALBERO MOTORE	1	CRANK SHAFT OIL SEAL

adattabile a: suitable for :	motore: engine :
SMART	M160910      M160923 M160920      M160E6ALB03 M160921      M160E6ALB04 M160922      M160E6ALB05

**KIT TENDICATENA**

**TIMING CHAIN KIT**

**SRI032023KSK**

9 pcs



composizione :	q.ty	composition:
CATENA DI DISTRIBUZIONE	1	TIMING CHAIN
TENDICATENA	1	TENSIONER
INGRANAGGIO	3	GEAR
PATTINO	3	GUIDE
VITI BULLONI	1	SCREWS BOLTS

adattabile a: suitable for :	motore: engine :	
CITROËN	F1CE0481DF30DT	F1CE348IEF30DTE
FIAT	F1CE0441A F1CE3481N	F1CFA401A
IVECO	F1CE0441A F1CE0481A F1CE0481B F1CE0481FA F1CE0481HA	F1CE0481HC F1CE0481L F1CE0481P F1CFA401A
PEUGEOT	F1CE0481DF30DT	F30DT

**SRI032030KSK**

4 pcs



composizione :	q.ty	composition:
CATENA DI DISTRIBUZIONE	1	TIMING CHAIN
PATTINO TENDICATENA DX	1	RIGHT GUIDE
PATTINO TENDICATENA SX	1	LEFT GUIDE
TENDICATENA	1	TENSIONER

adattabile a: suitable for :	motore: engine :	
SMART	M132910	M132930

**SRI032029KSK**

4 pcs



composizione :	q.ty	composition:
CATENA DI DISTRIBUZIONE	1	TIMING CHAIN
PATTINO TENDICATENA DX	1	RIGHT GUIDE
PATTINO TENDICATENA SX	1	LEFT GUIDE
TENDICATENA	1	TENSIONER

adattabile a: suitable for :	motore: engine :	
SMART	OM660940 OM660950	OM660951 OM660DE8LA

**SRI032033KSK**

5 pcs



composizione :	q.ty	composition:
CATENA DI DISTRIBUZIONE	1	TIMING CHAIN
TENDICATENA	1	TENSIONER
PATTINO	2	GUIDE
PARAOILIO	1	OIL SEAL

adattabile a: suitable for :	motore: engine :	
MERCEDES	M166940 M166960 M166961	M166990 M166991 M166995

**KIT TENDICATENA**

**TIMING CHAIN KIT**

**SRI032037KSK**

4 pcs



composizione :	q.ty	composition:
CATENA DI DISTRIBUZIONE	1	TIMING CHAIN
PATTINO TENDICATENA DX	1	RIGHT GUIDE
PATTINO TENDICATENA SX	1	LEFT GUIDE
TENDICATENA	1	TENSIONER

adattabile a: suitable for :	motore: engine :	
SEAT	AZQ BME	BXV BZG
SKODA	AZQ BME	BZG CEVA
VOLKSWAGEN	AZQ BME	BZG

**SRI032042KSK**

4 pcs



composizione :	q.ty	composition:
CATENA DI DISTRIBUZIONE	1	TIMING CHAIN
PATTINO TENDICATENA INF.DX	1	LOWER RIGHT GUIDE
PATTINO TENDICATENA INF.SX	1	LOWER LEFT GUIDE
TENDICATENA	1	TENSIONER

adattabile a: suitable for :	motore: engine :	
BMW	M47D20204D4 M47N204D4 M57306D3 M57D25256D2 M57D30306D2 M57D30306D3	M57D30306D4 M57D30306D5 M57N2306D2 M57N2306D3 M57N2306D5

**SRI032038KSK**

5 pcs



composizione :	q.ty	composition:
CATENA POMPA OLIO	1	OIL PUMP CHAIN
INGRANAGGIO	2	GEAR
TENDICATENA POMPA OLIO	1	OIL PUMP TENSIONER
PARAOLIO	1	OIL SEAL

adattabile a: suitable for :	motore: engine :	
SEAT	AZQ BBM BME	BXV BZG
SKODA	AWY AZQ BBM BMD	BME BZG CEVA
VOLKSWAGEN	AWY AZQ BBM BMD	BME BZG CHFA CHFB

**SRI032043KSK**

4 pcs



composizione :	q.ty	composition:
CATENA DI DISTRIBUZIONE	1	TIMING CHAIN
PATTINO TENDICATENA INF.DX	1	LOWER RIGHT GUIDE
PATTINO TENDICATENA INF.SX	1	LOWER LEFT GUIDE
TENDICATENA SUPERIORE	1	UPPER TENSIONER

adattabile a: suitable for :	motore: engine :	
BMW	B37C15A B37D15A B57D30A B57D30B N47D16A N47D20A	N47D20B N47D20C N47D20D N57D30A N57D30B N57D30C
MINI	B37C15A N47C16A	N47C20A

**KIT TENDICATENA**

**TIMING CHAIN KIT**

**SRI032044KSK**

7 pcs



composizione :	q.ty	composition:
CATENA DI DISTRIBUZ. SUP.	1	UPPER TIMING CHAIN
INGRANAGGIO	2	GEAR
PATTINO TENDICATENA SUP.DX	1	UPPER RIGHT GUIDE
PATTINO TENDICATENA SUP.SX	1	UPPER LEFT GUIDE
PATTINO TENDICATENA SUP.	1	UPPER GUIDE
TENDICATENA SUPERIORE	1	UPPER TENSIONER

adattabile a: suitable for :	motore: engine :
HYUNDAI	D4CB
KIA	D4CB

**SRI032054KSK**

7 pcs



composizione :	q.ty	composition:
CATENA DI DISTRIBUZIONE	1	TIMING CHAIN
TENDICATENA	1	TENSIONER
INGRANAGGIO	3	GEAR
PATTINO TENDICATENA DX	1	RIGHT GUIDE
PATTINO TENDICATENA SX	1	LEFT GUIDE

adattabile a: suitable for :	motore: engine :
SEAT	BZG CGPA CGPB CGPC CJLB
SKODA	CGPA CGPB CGPC
VOLKSWAGEN	CGPA CGPB CJLA

**SRI032048KSK**

4 pcs



composizione :	q.ty	composition:
CATENA DI DISTRIBUZIONE	1	TIMING CHAIN
GUIDA CATENA	2	GUIDE
TENDICATENA	1	TENSIONER

adattabile a: suitable for :	motore: engine :
OPEL	X20DTH X20DTL X22DTH Y20DTH Y20DTL Y22DTH Y22DTR
VAUXHALL	X20DTH X20DTL X22DTH Y20DTH Y20DTL Y22DTH Y22DTR

**SRI032056KSK**

7 pcs



composizione :	q.ty	composition:
CATENA DI DISTRIBUZIONE	1	TIMING CHAIN
TENDICATENA + PATTINO	1	TENSIONER + GUIDE

adattabile a: suitable for :	motore: engine :
MERCEDES	M271820 M271860 M271861 M271921 M271940 M271941 M271942 M271944 M271946 M271948 M271950 M271951 M271952 M271954 M271955 M271956 M271957 M271958

**KIT TENDICATENA**

**TIMING CHAIN KIT**

**SRI032057KSK**

7 pcs



composizione :	q.ty	composition:
CATENA DI DISTRIBUZIONE	1	TIMING CHAIN
TENDICATENA	1	TENSIONER
INGRANAGGIO	1	GEAR
PATTINO TENDICATENA DX	1	RIGHT GUIDE
PATTINO TENDICATENA SX	1	LEFT GUIDE
PARAOILIO ALBERO MOTORE	1	CRANK SHAFT OIL SEAL
VITI	1	SCREWS

adattabile a: suitable for :	motore: engine :
AUDI	CBZA CBZB
SEAT	CBZA CBZB
SKODA	CBZA CBZB
VOLKSWAGEN	CBZA CBZB CBZC

**SRI032058KSK**

7 pcs



composizione :	q.ty	composition:
CATENA DI DISTRIBUZIONE	1	TIMING CHAIN
TENDICATENA	1	TENSIONER
INGRANAGGIO	1	GEAR
PATTINO	3	GUIDE
GRUPPO GETTO	1	OIL NOZZLE

adattabile a: suitable for :	motore: engine :
ALFA ROMEO	939A5000 939A6000
CHEVROLET	A24XE LE5 A24XF LE9
OPEL	A20NFT A24XELE9 A20NHT B20NFT A24XE Z20NHH
VAUXHALL	A20NFT A24XELE9 A20NHT B20NFT A24XE

**SRI032065KSK**

14 pcs



composizione :	q.ty	composition:
CATENA DI DISTRIBUZIONE	1	TIMING CHAIN
TENDICATENA	1	TENSIONER
INGRANAGGIO	1	GEAR
PATTINO	3	GUIDE
VITI BULLONI	7	SCREWS BOLTS
RONDELLA	1	WASHERS

adattabile a: suitable for :	motore: engine :
ALFA ROMEO	939A5000 939A6000
FIAT	194A1000
OPEL	Z22SE Z22YH
VAUXHALL	Z22SE Z22YH

**SRI032066KSK**

7 pcs

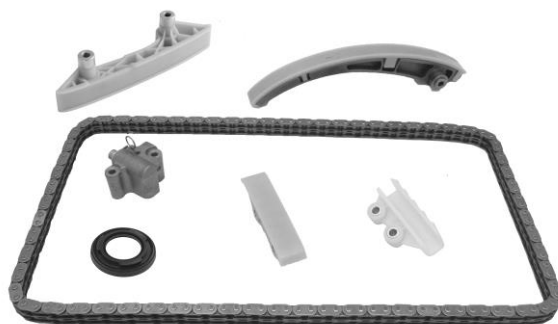

composizione :	q.ty	composition:
CATENA DI DISTRIBUZIONE	1	TIMING CHAIN
TENDICATENA	1	TENSIONER
PATTINO	4	GUIDE
PARAOILIO ALBERO MOTORE	1	CRANK SHAFT OIL SEAL

adattabile a: suitable for :	motore: engine :
FORD	D2FA FMBA D2FB FMBB D2FE HJBA D5BA HJBB D6BA HJBC F4FA N7BA

**KIT TENDICATENA**

**TIMING CHAIN KIT**

**SRI032068KSK**

7 pcs



composizione :	q.ty	composition:
CATENA DI DISTRIBUZIONE	1	TIMING CHAIN
TENDICATENA	1	TENSIONER
PATTINO	4	GUIDE
PARAOILIO ALBERO MOTORE	1	CRANK SHAFT OIL SEAL

adattabile a:	suitable for :	motore:	engine :
FORD	H9FA H9FB H9FD JXFA	JXFC PHFA PHFC	

**SRI032071KSK**

7 pcs



composizione :	q.ty	composition:
CATENA DI DISTRIBUZIONE	1	TIMING CHAIN
TENDICATENA	1	TENSIONER
PATTINO	3	GUIDE
INGRANAGGIO	2	GEAR

adattabile a:	suitable for :	motore:	engine :
HYUNDAI	D3FA D4FA	D4FB	
KIA	D3FA D4FA	D4FB D4FBL	

**SRI032069KSK**

7 pcs

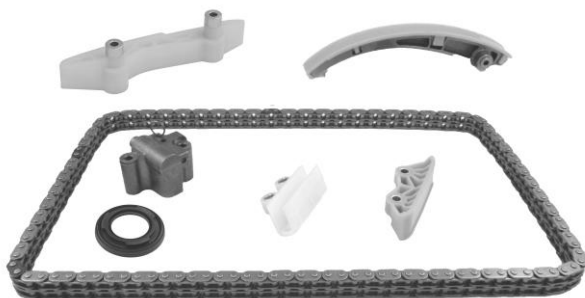

composizione :	q.ty	composition:
CATENA DI DISTRIBUZIONE	1	TIMING CHAIN
TENDICATENA	1	TENSIONER
PATTINO	4	GUIDE
PARAOILIO ALBERO MOTORE	1	CRANK SHAFT OIL SEAL

adattabile a:	suitable for :	motore:	engine :
FORD	D4FA DOFA	HFFA	

**SRI032077KSK**

3 pcs



composizione :	q.ty	composition:
PATTINO	2	GUIDE
VITI BULLONI	1	SCREWS BOLTS

adattabile a:	suitable for :	motore:	engine :
FIAT	F1CE0481D F1CE3481E	F1CE3481M F1CE3481N	
IVECO	F1CE3481C F1CE3481CA F1CE3481CB F1CE3481D F1CE3481J F1CE3481K F1CE3481L	F1CE3481LC F1CFL411E F1CFL411F F1CFL411G F1CFL411H F1CFL411J	

**KIT TENDICATENA**

**TIMING CHAIN KIT**

**SRI033000KSK**

4 pcs



composizione :	q.ty	composition:
CATENA DI DISTRIBUZIONE	1	TIMING CHAIN
TENDICATENA	1	TENSIONER
PATTINO TENDICATENA DX	1	RIGHT GUIDE
PATTINO TENDICATENA SX	1	LEFT GUIDE

adattabile a: suitable for :	motore: engine :	
ALFA ROMEO	199A3000 199B1000 199B4000	199B8000 330A1000
CHEVROLET	A13DTC	A13DTELSF
CITROËN	FHYF13DTE6	FHZF13DTE5
FIAT	169A1000 169A5000 188A8000 188A9000 199A2000 199A3000 199A9000 199B1000 199B2000 199B4000 199B8000	223A9000 225A2000 263A2000 263A6000 312A8000 312B1000 312B2000 330A1000 55266963 955B2000
FORD	FD4	
LANCIA	188A9000 199A2000 199A3000 199A9000	199B1000 312B1000 312B5000
OPEL	A13DTC A13DTE A13DTR A13FD	Z13DT Z13DTE Z13DTH Z13DTJ
PEUGEOT	199A9000 FHYF13DTE6	FHZF13DTE5
SUZUKI	D13A Z13DT	Z13DTJ
VAUXHALL	A13DTC A13DTE A13DTR A13FD	Z13DT Z13DTE Z13DTH Z13DTJ

**SRI033019KSK**

12 pcs



composizione :	q.ty	composition:
CATENA DI DISTRIBUZIONE	1	TIMING CHAIN
TENDICATENA	1	TENSIONER
PATTINO	4	GUIDE
INGRANAGGIO	5	GEAR
PARAOILIO ALBERO MOTORE	1	CRANK SHAFT OIL SEAL

adattabile a: suitable for :	motore: engine :	
MITSUBISHI	4M41	

**SRI033022KSK**

4 pcs



composizione :	q.ty	composition:
CATENA DI DISTRIBUZIONE	1	TIMING CHAIN
PATTINO TENDICATENA INF.DX	1	LOWER RIGHT GUIDE
PATTINO TENDICATENA INF.SX	1	LOWER LEFT GUIDE
TENDICATENA	1	TENSIONER

adattabile a: suitable for :	motore: engine :	
SMART	M160910 M160920 M160921 M160922	M160923 M160E6ALB03 M160E6ALB04 M160E6ALB05

**KIT TENDICATENA**

**TIMING CHAIN KIT**

**SRI033029KSK**

6 pcs

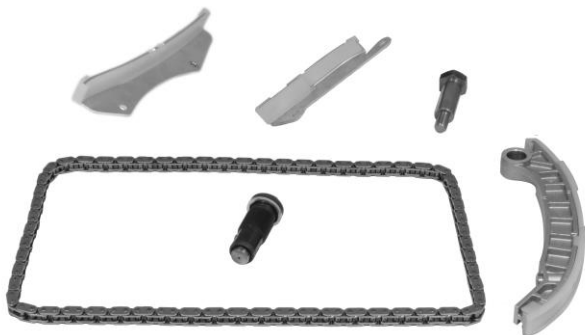

composizione :	q.ty	composition:
CATENA DI DISTRIBUZIONE	1	TIMING CHAIN
TENDICATENA	1	TENSIONER
PATTINO	3	GUIDE
VITI BULLONI	1	SCREWS BOLTS

adattabile a: suitable for :	motore: engine :	
CITROËN	F1CE0481DF30DT	F1CE348IEF30DTE
FIAT	F1CE0441A F1CE3481N	F1CFA401A
IVECO	F1CE0441A F1CE0481A F1CE0481B F1CE0481FA F1CE0481HA	F1CE0481HC F1CE0481L F1CE0481P F1CFA401A
PEUGEOT	F1CE0481DF30DT	F30DT

**SRI033033KSK**

4 pcs



composizione :	q.ty	composition:
CATENA	1	T CHAIN
PATTINO	2	GUIDE
TENDICATENA	1	TENSIONER

adattabile a: suitable for :	motore: engine :	
MERCEDES	M166940 M166960 M166961	M166990 M166991 M166995

**SRI033029KSK**

6 pcs



composizione :	q.ty	composition:
CATENA POMPA OLIO	1	OIL PUMP CHAIN
INGRANAGGIO	2	GEAR
GUIDA CATENA	1	TENSIONER GUIDE
MOLLA	1	SPRING
TUBETTO LUBRIFICAZ. OLIO	1	OIL FEED PIPE

adattabile a: suitable for :	motore: engine :	
SMART	OM660940 OM660950	OM660951 OM660DE8LA

**SRI033038KSK**

4 pcs

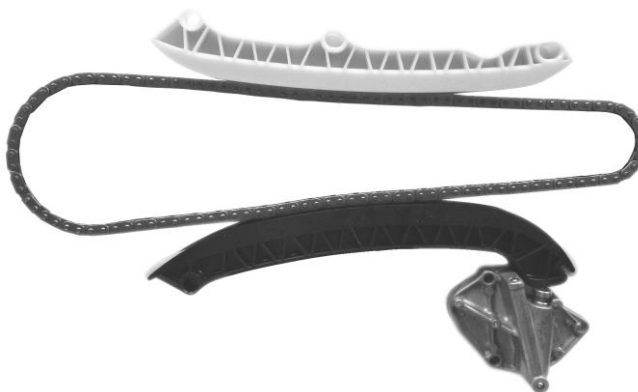

composizione :	q.ty	composition:
CATENA DI DISTRIBUZIONE	1	TIMING CHAIN
PATTINO TENDICATENA DX	1	RIGHT GUIDE
PATTINO TENDICATENA SX	1	LEFT GUIDE
TENDICATENA	1	TENSIONER

adattabile a: suitable for :	motore: engine :	
SEAT	BBM	
SKODA	AWY BBM	BMD
VOLKSWAGEN	AWY BBM BMD	CHFA CHFB



**KIT TENDICATENA**

**TIMING CHAIN KIT**

**SRI033043KSK**

4 pcs



composizione :	q.ty	composition:
CATENA DI DISTRIBUZIONE	1	TIMING CHAIN
PATTINO TENDICATENA INF.DX	1	LOWER RIGHT GUIDE
PATTINO TENDICATENA INF.SX	1	LOWER LEFT GUIDE
TENDICATENA INF.	1	LOWER TENSIONER

adattabile a: suitable for :	motore: engine :
BMW	N47D16A N47D20A N47D20B
MINI	N47C16A

**SRI033048KSK**

8 pcs



composizione :	q.ty	composition:
CATENA DI DISTRIBUZIONE	2	TIMING CHAIN
GUIDA CATENA	4	GUIDE
TENDICATENA	2	TENSIONER

adattabile a: suitable for :	motore: engine :
OPEL	X20DTH X20DTL X22DTH Y20DTH
VAUXHALL	X20DTH X20DTL X22DTH Y20DTH

**SRI033044KSK**

5 pcs



composizione :	q.ty	composition:
CATENA DI DISTRIBUZIONE	1	TIMING CHAIN
TENDICATENA SUPERIORE	1	UPPER TENSIONER
PATTINO TENDICATENA SUP.DX	1	UPPER RIGHT GUIDE
PATTINO TENDICATENA SUP.SX	1	UPPER LEFT GUIDE
PATTINO TENDICATENA SUP.	1	UPPER GUIDE

adattabile a: suitable for :	motore: engine :
HYUNDAI	D4CB
KIA	D4CB

**SRI033054KSK**

6 pcs

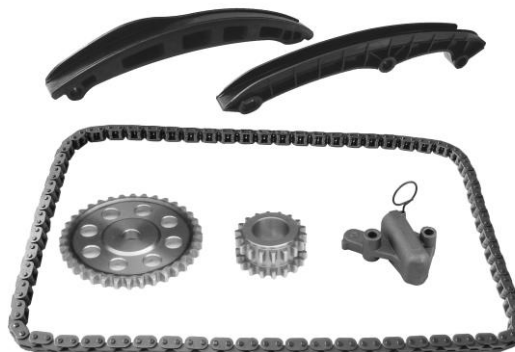

composizione :	q.ty	composition:
CATENA DI DISTRIBUZIONE	1	TIMING CHAIN
INGRANAGGIO	2	GEAR
PATTINO	2	GUIDE
TENDICATENA	1	TENSIONER

adattabile a: suitable for :	motore: engine :
AUDI	CAXA CAXC
SEAT	CAXC
SKODA	CAXA
VOLKSWAGEN	CAXA

**KIT TENDICATENA**

**TIMING CHAIN KIT**

**SRI033068KSK**

8 pcs



composizione :	q.ty	composition:
CATENA DI DISTRIBUZIONE	1	TIMING CHAIN
TENDICATENA	1	TENSIONER
PATTINO	4	GUIDE
GUARNIZIONE CARTER DISTR.	1	TIMING CASE COVER GASKET
PARAOILIO ALBERO MOTORE	1	CRANK SHAFT OIL SEAL

adattabile a: suitable for :	motore: engine :
FORD	CV24 CVFF CVR5 CVRA CVRB CVRC CY24 CYFF CYR5 CYRA CYRB CYRC
	DRR5 DRRA DRRB DRRC GBVAJPF GBVAJQJ GBVAJQW Q2JSGBJVJQJ UHR5 USR6 USRA USR6 UYR6

**SRI033069KSK**

7 pcs

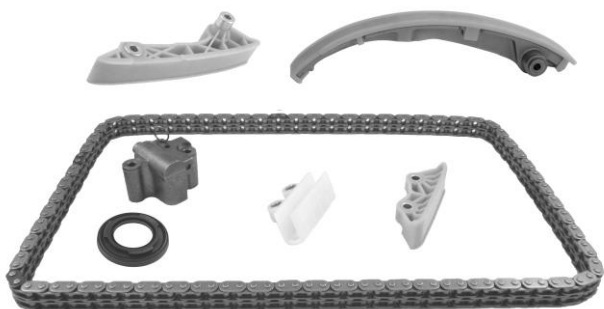

composizione :	q.ty	composition:
CATENA DI DISTRIBUZIONE	1	TIMING CHAIN
TENDICATENA	1	TENSIONER
PATTINO	4	GUIDE
PARAOILIO ALBERO MOTORE	1	CRANK SHAFT OIL SEAL

adattabile a: suitable for :	motore: engine :
FORD	D4FA DOFA FXFA
	H9FA HFFA

**SRI033071KSK**

5 pcs



composizione :	q.ty	composition:
CATENA DI DISTRIBUZIONE	1	TIMING CHAIN
INGRANAGGIO	1	GEAR
TENDICATENA	1	TENSIONER
PATTINO	2	GUIDE

adattabile a: suitable for :	motore: engine :
HYUNDAI	D3FA D4FA
	D4FB D4FC
KIA	D3FA D4FA D4FB
	D4FB5 D4FBL D4FC

**SRI033077KSK**

5 pcs



composizione :	q.ty	composition:
CATENA DI DISTRIBUZIONE	1	TIMING CHAIN
INGRANAGGIO	2	GEAR
PATTINO	2	GUIDE

adattabile a: suitable for :	motore: engine :
FIAT	F1CE0481D F1CE3481E
	F1CE3481M F1CE3481N
IVECO	F1CE3481C F1CE3481CA F1CE3481CB F1CE3481D F1CE3481J F1CE3481K F1CE3481L
	F1CE3481LC F1CFL411E F1CFL411F F1CFL411G F1CFL411H F1CFL411J

**KIT TENDICATENA**

**TIMING CHAIN KIT**

**SRI034000KSK**

9 pcs



composizione :	q.ty	composition:
CATENA DI DISTRIBUZIONE	1	TIMING CHAIN
INGRANAGGIO	2	GEAR
PATTINO	2	GUIDE
TENDICATENA	1	TENSIONER
PARAOILIO ALBERO MOTORE	1	CRANK SHAFT OIL SEAL
GUARNIZIONE CARTER DISTR.	1	TIMING CASE COVER GASKET
CONDOTTO DI LUBRIFICAZIONE	1	OIL FEED PIPE

adattabile a: suitable for :	motore: engine :	
ALFA ROMEO	199A3000 199B1000 199B4000	199B8000 330A1000
CHEVROLET	A13DTC	A13DTELSF
CITROËN	FHYF13DTE6	FHZF13DTE5
FIAT	169A1000 169A5000 188A8000 188A9000 199A2000 199A3000 199A9000 199B1000 199B2000 199B4000 199B8000	223A9000 225A2000 263A2000 263A6000 312A8000 312B1000 312B2000 330A1000 55266963 955B2000
FORD	FD4	
LANCIA	188A9000 199A2000 199A3000 199A9000	199B1000 312B1000 312B5000
OPEL	A13DTC A13DTE A13DTR A13FD	Z13DT Z13DTE Z13DTH Z13DTJ
PEUGEOT	199A9000 FHYF13DTE6	FHZF13DTE5
SUZUKI	D13A Z13DT	Z13DTJ
VAUXHALL	A13DTC A13DTE A13DTR A13FD	Z13DT Z13DTE Z13DTH Z13DTJ

**SRI034023KSK**

8 pcs

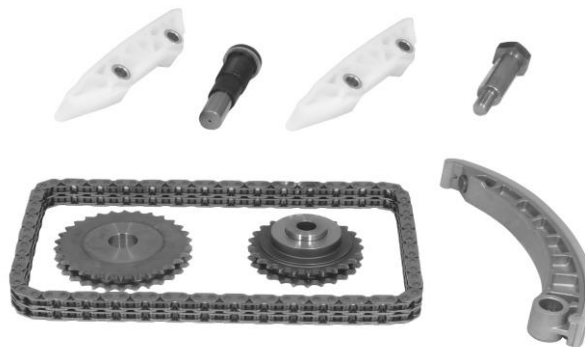

composizione :	q.ty	composition:
CATENA DI DISTRIBUZIONE INF.	1	LOWER TIMING CHAIN
INGRANAGGIO	2	GEAR
TENDICATENA	1	TENSIONER
PATTINO	3	GUIDE
VITI BULLONI	1	SCREWS BOLTS

adattabile a: suitable for :	motore: engine :	
CITROËN	F1CE0481DF30DT	F1CE3481EF30DTE
FIAT	F1CE0441A F1CE3481N	F1CFA401A
IVECO	F1CE0441A F1CE0481A F1CE0481B F1CE0481FA F1CE0481HA	F1CE0481HC F1CE0481L F1CE0481P F1CFA401A
PEUGEOT	F1CE0481DF30DT	F30DT

**SRI034029KSK**

4 pcs



composizione :	q.ty	composition:
CATENA POMPA OLIO	1	OIL PUMP CHAIN
GUIDA TENDICATENA	1	TENSIONER GUIDE
TUBETTO LUBRIFICAZ. OLIO	1	OIL FEED PIPE
MOLLA	1	SPRING

adattabile a: suitable for :	motore: engine :	
SMART	OM660940 OM660950	OM660951 OM660DE8LA

**KIT TENDICATENA**

**TIMING CHAIN KIT**

**SRI034038KSK**

2 pcs



composizione :	q.ty	composition:
CATENA POMPA OLIO	1	OIL PUMP CHAIN
TENDICATENA POMPA OLIO	1	OIL PUMP TENSIONER

adattabile a: suitable for :	motore: engine :	
SEAT	AZQ BBM BME	BXV BZG
SKODA	AWY AZQ BBM BMD	BME BZG CEVA
VOLKSWAGEN	AWY AZQ BBM BMD	BME BZG CHFA CHFB

**SRI034066KSK**

7 pcs



composizione :	q.ty	composition:
CATENA DI DISTRIBUZIONE	1	TIMING CHAIN
PATTINO	4	GUIDE
TENDICATENA	1	TENSIONER
PARAOLIO ALBERO MOTORE	1	CRANK SHAFT OIL SEAL

adattabile a: suitable for :	motore: engine :	
FORD	ABFA D3FA F3FA FIFA	FMBA FMBB N7BA

**SRI034044KSK**

4 pcs



composizione :	q.ty	composition:
CATENA DI DISTRIBUZ. INF.SX	1	LOWER LEFT TIMING CHAIN
PATTINO TENDICATENA INF.DX	1	LOWER RIGHT GUIDE
PATTINO TENDICATENA INF.SX	1	LOWER LEFT GUIDE
TENDICATENA INF.SX	1	LOWER LEFT TENSIONER

adattabile a: suitable for :	motore: engine :	
HYUNDAI	D4CB	
KIA	D4CB	

**SRI034068KSK**

8 pcs



composizione :	q.ty	composition:
CATENA DI DISTRIBUZIONE	1	TIMING CHAIN
PATTINO	4	GUIDE
TENDICATENA	1	TENSIONER
PARAOLIO ALBERO MOTORE	1	CRANK SHAFT OIL SEAL
GUARNIZIONE CARTER DISTR.	1	TIMING CASE COVER GASKET

adattabile a: suitable for :	motore: engine :	
FORD	H9FA H9FB H9FD JXFA	JXFC PHFA PHFC

**KIT TENDICATENA**

**TIMING CHAIN KIT**

**SRI034071KSK**

5 pcs



composizione :	q.ty	composition:
CATENA DI DISTRIBUZIONE	1	TIMING CHAIN
PATTINO	3	GUIDE
TENDICATENA	1	TENSIONER

adattabile a: suitable for :	motore: engine :
HYUNDAI	D3FA D4FA D4FB
KIA	D3FA D4FA D4FB D4FBL

**SRI035044KSK**

4 pcs



composizione :	q.ty	composition:
CATENA DI DISTRIBUZ. INF.DX	1	LOWER RIGHT TIMING CHAIN
PATTINO TENDICATENA INF.DX	1	LOWER RIGHT GUIDE
PATTINO TENDICATENA INF.SX	1	LOWER LEFT GUIDE
TENDICATENA INF.DX	1	LOWER RIGHT TENSIONER

adattabile a: suitable for :	motore: engine :
HYUNDAI	D4CB D4CBL D4CBW
KIA	D4CB

**SRI035023KSK**

6 pcs



composizione :	q.ty	composition:
CATENA DI DISTRIBUZIONE INF.	1	LOWER TIMING CHAIN
TENDICATENA	1	TENSIONER
PATTINO	3	GUIDE
VITI BULLONI	1	SCREWS BOLTS

adattabile a: suitable for :	motore: engine :
CITROËN	F1CE0481DF30DT F1CE348IEF30DTE
FIAT	F1CE0441A F1CE3481N F1CFA401A
IVECO	F1CE0441A F1CE0481A F1CE0481B F1CE0481FA F1CE0481HA F1CE0481HC F1CE0481L F1CE0481P F1CFA401A
PEUGEOT	F1CE0481DF30DT F30DT

**SRI035066KSK**

7 pcs



composizione :	q.ty	composition:
CATENA DI DISTRIBUZIONE	1	TIMING CHAIN
PATTINO	4	GUIDE
TENDICATENA	1	TENSIONER
PARAOILIO ALBERO MOTORE	1	CRANK SHAFT OIL SEAL

adattabile a: suitable for :	motore: engine :
FORD	ABFA D3FA F3FA FIFA FMBA FMBB N7BA

**KIT TENDICATENA**

**TIMING CHAIN KIT**

**SRI035068KSK**

18 pcs



composizione :	q.ty	composition:
CATENA DI DISTRIBUZIONE	1	TIMING CHAIN
INGRANAGGIO	4	GEAR
PATTINO	4	GUIDE
TENDICATENA	1	TENSIONER
GUARNIZIONE CARTER DISTR.	1	TIMING CASE COVER GASKET
PARAOLIO ALBERO MOTORE	1	CRANK SHAFT OIL SEAL
VITI BULLONI	6	SCREWS BOLTS

adattabile a: suitable for :	motore: engine :
FORD	H9FA H9FB H9FD JXFA JXFC PHFA PHFC

**SRI035071KSK**

4 pcs



composizione :	q.ty	composition:
CATENA DI DISTRIBUZIONE	1	TIMING CHAIN
PATTINO	2	GUIDE
TENDICATENA	1	TENSIONER

adattabile a: suitable for :	motore: engine :
HYUNDAI	D3FA D4FA D4FB D4FB5P D4FC D4FCM D4FD
KIA	D3FA D4FA D4FB D4FB5 D4FBL D4FC D4FD D4FDL

**SRI036023KSK**

5 pcs

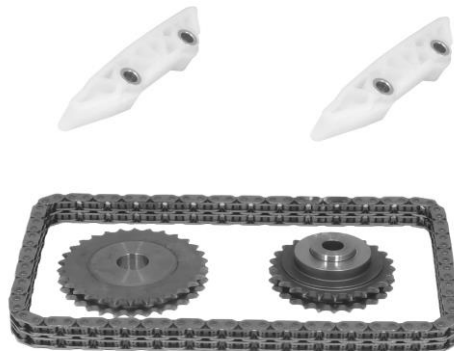

composizione :	q.ty	composition:
CATENA DI DISTRIBUZIONE	1	TIMING CHAIN
INGRANAGGIO	2	GEAR
PATTINO	2	GUIDE

adattabile a: suitable for :	motore: engine :
CITROËN	F1CE0481DF30DT F1CE3481N F1CE3481EF30DTE
FIAT	F1CE0441A F1CE3481N F1CFA401A
IVECO	F1CE0441A F1CE0481A F1CE0481B F1CE0481FA F1CE0481HA F1CE0481HC F1CE0481L F1CE0481P F1CFA401A
PEUGEOT	F1CE0481DF30DT F30DT

**SRI036068KSK**

18 pcs



composizione :	q.ty	composition:
CATENA DI DISTRIBUZIONE	1	TIMING CHAIN
INGRANAGGIO	4	GEAR
PATTINO	4	GUIDE
TENDICATENA	1	TENSIONER
GUARNIZIONE CARTER DISTR.	1	TIMING CASE COVER GASKET
PARAOLIO ALBERO MOTORE	1	CRANK SHAFT OIL SEAL
VITI BULLONI	6	SCREWS BOLTS

adattabile a: suitable for :	motore: engine :
FORD	CV24 CVFF CVR5 CVRA CVRB CVRC CY24 CYFF CYR5 CYRA CYRB CYRC DRR5 DRRA DRRB DRRC GBVAJPF GBVAJQJ GBVAJQW UHR5 USR6 USRA USRB UYR6

**KIT TENDICATENA**

**TIMING CHAIN KIT**

**SRI039001KSK**

5 pcs



composizione :	q.ty	composition:
CATENA DI DISTRIBUZIONE	1	TIMING CHAIN
INGRANAGGIO	2	GEAR
GUARNIZIONE CARTER	1	COVER GASKET
PARAOILIO ALBERO MOTORE	1	CRANK SHAFT OIL SEAL

adattabile a:	suitable for :	motore:	engine :
FIAT	110000 126A000 126A1000		126A1048 126A2000 126A2048

**SRI039003KSK**

5 pcs



composizione :	q.ty	composition:
CATENA DI DISTRIBUZIONE	1	TIMING CHAIN
INGRANAGGIO	2	GEAR
GUARNIZIONE CARTER	1	COVER GASKET
PARAOILIO ALBERO MOTORE	1	CRANK SHAFT OIL SEAL

adattabile a:	suitable for :	motore:	engine :
FIAT			

**SRI039002KSK**

5 pcs



composizione :	q.ty	composition:
CATENA DI DISTRIBUZIONE	1	TIMING CHAIN
INGRANAGGIO	2	GEAR
GUARNIZIONE CARTER	1	COVER GASKET
PARAOILIO ALBERO MOTORE	1	CRANK SHAFT OIL SEAL

adattabile a:	suitable for :	motore:	engine :
FIAT			

**SRI039004KSK**

5 pcs



composizione :	q.ty	composition:
CATENA DI DISTRIBUZIONE	1	TIMING CHAIN
INGRANAGGIO	2	GEAR
GUARNIZIONE CARTER	1	COVER GASKET
PARAOILIO ALBERO MOTORE	1	CRANK SHAFT OIL SEAL

adattabile a:	suitable for :	motore:	engine :
FIAT			

**KIT TENDICATENA**

**TIMING CHAIN KIT**

**SRI039005KSK**

5 pcs



composizione :	q.ty	composition:
CATENA DI DISTRIBUZIONE	1	TIMING CHAIN
INGRANAGGIO	2	GEAR
GUARNIZIONE CARTER	1	COVER GASKET
PARAOLIO ALBERO MOTORE	1	CRANK SHAFT OIL SEAL

adattabile a:	suitable for :	motore:	engine :
FIAT			

**SRI039007KSK**

5 pcs



composizione :	q.ty	composition:
CATENA DI DISTRIBUZIONE	1	TIMING CHAIN
INGRANAGGIO	2	GEAR
GUARNIZIONE CARTER	1	COVER GASKET
PARAOLIO ALBERO MOTORE	1	CRANK SHAFT OIL SEAL

adattabile a:	suitable for :	motore:	engine :
FIAT			

**SRI039006KSK**

5 pcs



composizione :	q.ty	composition:
CATENA DI DISTRIBUZIONE	1	TIMING CHAIN
INGRANAGGIO	2	GEAR
GUARNIZIONE CARTER	1	COVER GASKET
PARAOLIO ALBERO MOTORE	1	CRANK SHAFT OIL SEAL

adattabile a:	suitable for :	motore:	engine :
FIAT			

**SRI039008KSK**

5 pcs



composizione :	q.ty	composition:
CATENA DI DISTRIBUZIONE	1	TIMING CHAIN
INGRANAGGIO	2	GEAR
GUARNIZIONE CARTER	1	COVER GASKET
PARAOLIO ALBERO MOTORE	1	CRANK SHAFT OIL SEAL

adattabile a:	suitable for :	motore:	engine :
FIAT			



**KIT TENDICATENA**

**TIMING CHAIN KIT**

**SRI039009KSK**

5 pcs



composizione :	q.ty	composition:
CATENA DI DISTRIBUZIONE	1	TIMING CHAIN
INGRANAGGIO	2	GEAR
GUARNIZIONE CARTER	1	COVER GASKET
PARAOILIO ALBERO MOTORE	1	CRANK SHAFT OIL SEAL

adattabile a: suitable for :	motore: engine :
FIAT	

**SRI039011KSK**

4 pcs

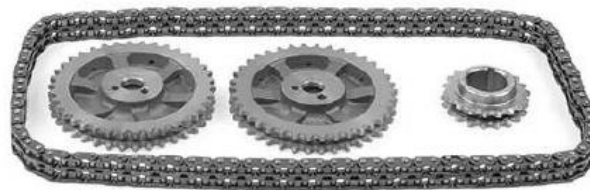

composizione :	q.ty	composition:
CATENA DI DISTRIBUZIONE	1	TIMING CHAIN
INGRANAGGIO	3	GEAR

adattabile a: suitable for :	motore: engine :
LADA	

**SRI039010KSK**

6 pcs



composizione :	q.ty	composition:
TENDICATENA	1	TENSIONER
CATENA DI DISTRIBUZIONE	1	TIMING CHAIN
INGRANAGGIO	2	GEAR
GUARNIZIONE CARTER	1	COVER GASKET
PARAOILIO ALBERO MOTORE	1	CRANK SHAFT OIL SEAL

adattabile a: suitable for :	motore: engine :	
FORD	GLA GLW JBB JLA	JLB TKA TKW TLA

**SRI039012KSK**

4 pcs



composizione :	q.ty	composition:
CATENA DI DISTRIBUZIONE	1	TIMING CHAIN
INGRANAGGIO	3	GEAR

adattabile a: suitable for :	motore: engine :
LADA	BA32103

**KIT TENDICATENA**

**TIMING CHAIN KIT**

**SRI039013KSK**

5 pcs



composizione :	q.ty	composition:
CATENA DI DISTRIBUZIONE	1	TIMING CHAIN
INGRANAGGIO	2	GEAR
GUARNIZIONE CARTER	1	COVER GASKET
TENDICATENA	1	TENSIONER

adattabile a: suitable for :	motore: engine :
PEUGEOT	150XY6B

**SRI039017KSK**

5 pcs



composizione :	q.ty	composition:
CATENA DI DISTRIBUZIONE	1	TIMING CHAIN
INGRANAGGIO	2	GEAR
GUARNIZIONE CARTER	1	COVER GASKET
TENDICATENA	1	TENSIONER

adattabile a: suitable for :	motore: engine :
RENAULT	689710 C1C708

**SRI039014KSK**

5 pcs



composizione :	q.ty	composition:
CATENA DI DISTRIBUZIONE	1	TIMING CHAIN
INGRANAGGIO	2	GEAR
GUARNIZIONE CARTER	1	COVER GASKET
PARAOLIO ALBERO MOTORE	1	CRANK SHAFT OIL SEAL

adattabile a: suitable for :	motore: engine :
PEUGEOT	108CXV8 109FXW7 F1

**SRI930005KSK**

8 pcs



composizione :	q.ty	composition:
CATENA DI DISTRIBUZIONE	1	TIMING CHAIN
INGRANAGGIO	2	GEAR
VARIATORE DI FASE	1	VARIATOR VALVE TIMING
TENDICATENA	1	TENSIONER
PATTINO	2	GUIDE
PARAOLIO ALBERO MOTORE	1	CRANK SHAFT OIL SEAL

adattabile a: suitable for :	motore: engine :
NISSAN	CG10DE

**KIT TENDICATENA**

**TIMING CHAIN KIT**

**SRI930007KSK**

8 pcs



composizione :	q.ty	composition:
CATENA DI DISTRIBUZIONE	1	TIMING CHAIN
INGRANAGGIO	2	GEAR
VARIATORE DI FASE	1	VARIATOR VALVE TIMING
TENDICATENA	1	TENSIONER
PATTINO	2	GUIDE
PARAOLIO ALBERO MOTORE	1	CRANK SHAFT OIL SEAL

adattabile a: suitable for :	motore: engine :
TOYOTA	1ZZFE 3ZZFE 4ZZFE

**SRI930017KSK**

8 pcs



composizione :	q.ty	composition:
CATENA DI DISTRIBUZIONE	1	TIMING CHAIN
INGRANAGGIO	2	GEAR
VARIATORE DI FASE	1	VARIATOR VALVE TIMING
TENDICATENA	1	TENSIONER
PATTINO	2	GUIDE
PARAOLIO ALBERO MOTORE	1	CRANK SHAFT OIL SEAL

adattabile a: suitable for :	motore: engine :	
CITROËN	1KRFE	
DAIHATSU	1KRFE	
PEUGEOT	1KR384F 384F	CFA384F
TOYOTA	1KRFE	

**SRI930012KSK**

9 pcs



composizione :	q.ty	composition:
CATENA DI DISTRIBUZIONE	1	TIMING CHAIN
INGRANAGGIO	2	GEAR
VARIATORE DI FASE	1	VARIATOR VALVE TIMING
TENDICATENA	1	TENSIONER
PATTINO	3	GUIDE
PARAOLIO ALBERO MOTORE	1	CRANK SHAFT OIL SEAL

adattabile a: suitable for :	motore: engine :
TOYOTA	1SZFE

**SRI930056KSK**

8 pcs



composizione :	q.ty	composition:
CATENA DI DISTRIBUZIONE	1	TIMING CHAIN
VARIATORE DI FASE	2	VARIATOR VALVE TIMING
TENDICATENA	1	TENSIONER
PATTINO	3	GUIDE
PARAOLIO ALBERO MOTORE	1	CRANK SHAFT OIL SEAL

adattabile a: suitable for :	motore: engine :	
MERCEDES	M271910	M271950
	M271911	M271951
	M271921	M271952
	M271940	M271955
	M271941	M271956
	M271942	M271957
	M271946	M271958
	M271948	

**KIT TENDICATENA**

**TIMING CHAIN KIT**

**SRI931046KSK**

9 pcs



composizione :	q.ty	composition:
CATENA DI DISTRIBUZIONE	1	TIMING CHAIN
INGRANAGGIO	2	GEAR
VARIATORE DI FASE	1	VARIATOR VALVE TIMING
TENDICATENA	1	TENSIONER
PATTINO	3	GUIDE
PARAOLIO ALBERO MOTORE	1	CRANK SHAFT OIL SEAL

adattabile a: suitable for :	motore: engine :	
CITROËN	5F04EP6CDT	5FREP6DT
	5FDEP6DTS	5FSEP6DTS
	5FEFP6CDTMD	5FTEP6DT
	5FMEP6CDTM	5FVEP6CDT
	5FMEP6DT	5FXEP6DT
	5FNEP6CDT	5GYEP6FTDM
	5FNEP6DT	5GZEP6FDT
PEUGEOT	5F02EP6CDT	5FXEP6DT
	5F04EP6CDT	5FYEP6DTS
	5FAEP6CDT	5G02EP6FTDM
	5FEFP6CDTMD	5G02EP6FTMD
	5FMEP6CDTM	5GXEP6FTMD
	5FNEP6CDT	5GYEP6FTDM
	5FREP6DT	5GZEP6FDT
	5FTEP6DT	EP6CDT
	5FVEP6CDT	EP6CDTM5FM
	5FVEP6DT	EP6FTMD

**SRI933054KSK**

8 pcs



composizione :	q.ty	composition:
CATENA DI DISTRIBUZIONE	1	TIMING CHAIN
INGRANAGGIO	2	GEAR
VARIATORE DI FASE	1	VARIATOR VALVE TIMING
TENDICATENA	1	TENSIONER
PATTINO	2	GUIDE
PARAOLIO ALBERO MOTORE	1	CRANK SHAFT OIL SEAL

adattabile a: suitable for :	motore: engine :	
AUDI	CAXA CAXC	CNVA
SEAT	CAXC	
SKODA	CAXA	CAXC
VOLKSWAGEN	CAXA	CMSB

**SRI932070KSK**

12 pcs



composizione :	q.ty	composition:
CATENA DI DISTRIBUZIONE	1	TIMING CHAIN
INGRANAGGIO	1	GEAR
PATTINO	3	GUIDE
TENDICATENA	1	TENSIONER
GUARNIZIONE POMPA OLIO	1	OIL PUMP GASKET
GUARNIZIONE POMPA ACQUA	1	WATER PUMP GASKET
VARIATORE DI FASE	2	VARIATOR VALVE TIMING
PARAOLIO ALBERO MOTORE	1	CRANK SHAFT OIL SEAL
VITI	1	SCREWS

adattabile a: suitable for :	motore: engine :
OPEL	Z12XEP
VAUXHALL	Z12XEP





SRI Italia®  
is a registered trademark  
of

**FINIMPIANTI S.r.l.**

Via Aldo Moro, 9 – 10080 Oglianico (TO) – Italy

Tel. +39 0124 470670 – Fax +30 0124 470686

e-mail: [info@finimpianti.it](mailto:info@finimpianti.it) – <http://www.finimpianti.it>